



PT2245PW

Touch Screen Monitor

USER'S GUIDE

www.planar.com

This document may not be copied in any form without permission from Planar. Information in this document is subject to change without notice.

Trademark Credits

Windows™ is a trademark of Microsoft Corp.

The terms HDMI, HDMI High-Definition Multimedia Interface, HDMI Trade dress and the HDMI Logos are trademarks or registered trademarks of HDMI Licensing Administrator, Inc.

All other companies are trademarks or registered trademarks of their respective companies.

Disclaimer

The information contained in this document is subject to change without notice. Planar Systems, Inc. makes no warranty of any kind with regard to this material. While every precaution has been taken in the preparation of this manual, the Company shall not be liable for errors or omissions contained herein or for incidental or consequential damages in connection with the furnishing, performance, or use of this material.

For more information on how to recycle your product, please visit WWW.PLANAR.COM/GREEN.

FCC RADIO FREQUENCY INTERFERENCE STATEMENT WARNING: (FOR FCC CERTIFIED MODELS)

This LED LCD Monitor has been tested and found compliant with the limits for a Class B digital device, pursuant to part 15 of the FCC Rules. These limits are designed to provide proper protection against harmful interference to a residential installation. This LED LCD Monitor generates, uses, and can radiate radio frequency energy. Harmful interference to radio communication may be the result if it's not properly installed and used. However, there is no guarantee that interference will not occur in a particular installation. If this LED LCD Monitor does cause serious interference to radio or television reception, resetting may correct it. Moreover, users are encouraged to reduce interference by doing one or more of the following:

- Reorient or relocate the receiving antenna.
- Move the LED LCD Monitor and the receiver further away from each other.
- Connect the LED LCD Monitor into an outlet on a circuit different from that to which the receiver is connected.
- Consult your local dealer or a qualified technician.

FCC Warning:

To assure a continued FCC compliance, a user must use a grounded power supply cord and the provided shielded video interface cable with bonded ferrite cores. Also, any unauthorized changes or modifications to this LED LCD Monitor would void the user's authority to operate this device.

Note: If necessary, shielded interface cables and AC power cord must be used to meet the emission level limits.

COMMUNIQUE D'AVERTISSEMENT DE LA FCC CONCERNANT LES INTERFERENCE DE FREQUENCE RADIO: (SEULEMENT POUR MODELES CERTIFIE PAR LA FCC)

Ce moniteur a été testé et a été trouvé conforme aux limites pour un appareil numérique de Classe B, suivant la partie 15 des règlements de la FCC. Ces limites ont été développées pour offrir une protection satisfaisante contre les interférences nuisibles dans une installation résidentielle. Ce moniteur génère, utilise et peut radier de l'énergie de fréquence radio. Ceci peut causer des interférences nuisibles à des communications radio si l'appareil n'est pas convenablement installé et utilisé. Il n'y a néanmoins aucune garantie que des interférences n'apparaîtront pas dans une installation particulière. Si ce moniteur cause de sérieuses interférences à la réception de signaux radios ou télévisés, une possibilité est de réinitialiser le moniteur. Les usagers sont aussi encouragés à corriger les interférences en appliquant une ou plusieurs des démarches suivantes:

- Réorientez ou déplacez l'antenne de réception.
- Placez le moniteur et le récepteur plus loin l'un de l'autre.
- Connectez le moniteur à une prise différente de celle à laquelle le récepteur est connecté.
- Consultez votre revendeur local ou un technicien qualifié.

Avertissement de la FCC:

Pour assurer une conformité continue aux règlements de la FCC, l'utilisateur doit utiliser un cordon d'alimentation mis à terre et le câble d'interface vidéo protégé avec noyaux en ferrite, fourni avec l'appareil. Chaque modification ou changement non-autorisé appliqué à ce moniteur peut faire perdre à l'utilisateur son droit d'opération de cet appareil.

Note: Si nécessaire, des câbles d'interface protégés et un cordon d'alimentation alternante doivent être utilisés pour être conformes aux limites d'émission.

Table of Contents

Usage Notice

Safety Precautions	1
--------------------------	---

Introduction

About PT2245PW Series	3
Touch Screen for PT2245PW	3
Package Overview	4

Installation

Product Overview	5
Front View	5
Bottom View (Without Stand)	5
VESA Mount for Your Monitor	6
Start Your Installation	7
Connecting the Display (Figure 9.1).....	8
(Figure 9.1)	9





User Controls

Side Panel Controls.....	10
How to Use the OSD Menus	11
On-Screen Display Menus	13

Appendix

Troubleshooting.....	14
Warning Signal	15
No Signal.....	15
Going to Sleep.....	15
Out of Range.....	15
Product Dimensions	16
Compatibility Modes	18
Touch Screen Driver Installation	19
PT2245PW Optional Calibration Tool Install.....	20
PT2245PW Install Instructions	21
Technical Support.....	22

Usage Notice

-  Warning - To prevent the risk of fire or shock hazards, and do not expose the product to moisture.
-  Warning - Please do not open or disassemble the product as this may cause electric shock.
-  Warning - Power cord shall be connected to a socket-outlet with earthing connection.
-  Warning - The cable cover cannot be removed under normal use conditions.
-  Warning - Stability Hazard. The touch monitor may fall, causing serious personal injury or death. To prevent injury, this touch monitor must be securely attached to the wall in accordance with the installation instructions.

Safety Precautions





Follow all warnings, precautions and maintenance as recommended in this user's manual to maximize the life of your unit.

Do:

- Turn off the product before cleaning.
- Surface may be cleaned using a soft clean cloth moistened with mild window glass commercial cleaners or 50/50 mixture of water and isopropyl alcohol.
- Use a soft cloth moistened with mild detergent to clean the display housing.
- Disconnect the power plug from AC outlet if the product is not going to be used for an extended period of time.

Don't:

- Do not touch the LED display screen surface with sharp or hard objects.
- Do not use abrasive cleaners, waxes or solvents for your cleaning.
- Do not operate the product under the following conditions:
 - Extremely hot, cold or humid environment.
 - Areas susceptible to excessive dust and dirt.
 - Near any appliance generating a strong magnetic field.
 - In direct sunlight.
 - For over 16 hours per day.
- If smoke, abnormal noise or odor emits from your LED LCD Monitor, remove the power cord immediately and call your service center.
- Never remove the rear cover of your LED LCD Monitor. The display unit inside contains high-voltage parts and may cause electric shock.
- Never try to repair your LED LCD Monitor yourself. Always call your service center or a qualified technician to fix it.
- Due to safety concerns, if the VESA mounting kit is purchased separately, please make sure the mounting kit is UL-listed, and replaceable only by service personnel.

	Mise en garde-	Pour prévenir les risques d'incendie ou d'électrocution, ne pas exposer le produit à l'humidité.
	Mise en garde-	Prière de ne pas ouvrir ou démonter le produit, car cela pourrait entraîner l'électrocution.
	Mise en garde-	Le cordon d'alimentation doit être branché à une prise pourvue d'une mise à la terre.
	Mise en garde-	La gaine du câble ne doit pas être retirée en conditions normales d'utilisation.
	Mise en garde-	Risque de renversement. Le moniteur tactile peut se renverser et causer de graves blessures corporelles, voire la mort. Pour prévenir les blessures, ce moniteur tactile doit être solidement fixé au mur selon les instructions d'installation.

Consignes de sécurité

Respectez tous les avertissements, les précautions et conseils d'entretien recommandés dans ce manuel de l'utilisateur pour maximiser la durée de vie de votre appareil.

A faire :

- Éteindre le produit avant de le nettoyer.
- La surface de l'écran tactile peut être nettoyée avec un chiffon doux et propre imprégné d'un nettoyant doux du commerce pour vitres ou d'un mélange à 50/50 d'alcool isopropylique et d'eau.
- Utilisez un chiffon doux imprégné d'un détergeant doux pour nettoyer le carter de l'affichage.
- Débranchez la fiche d'alimentation de la prise de courant secteur si le produit ne doit pas être utilisé pendant une période prolongée.

A ne pas faire :

- Ne touchez pas la surface de l'écran LED avec des objets coupants ou durs.
- N'utilisez pas des produits de nettoyage abrasifs, de la cire ou des solvants pour le nettoyage.
- N'utilisez pas le produit dans les conditions suivantes :
 - Environnement extrêmement chaud, froid ou humide.
 - Endroits poussiéreux ou sales.
 - Près d'appareils générant un fort champ magnétique.
 - Sous la lumière directe du soleil.
 - Plus de 16 heures par jour
- Si de la fumée, un bruit anormal ou une odeur s'échappait de votre moniteur LCD LED, débranchez immédiatement le cordon d'alimentation et appelez votre centre de réparation.
- Ne retirez jamais le couvercle arrière de votre moniteur LCD LED. L'unité d'affichage contient des éléments où circule un voltage élevé et présentant un risque d'électrocution.
- N'essayez jamais de réparer vous-même votre moniteur LCD LED. Faites toujours appel à votre centre de service ou à un technicien qualifié pour toute réparation.
- Pour des raisons de sécurité, si vous achetez séparément le kit de fixation VESA, assurez-vous que celui-ci est certifié UL, et qu'il peut être remplacé uniquement par un technicien qualifié.

Introduction

About PT2245PW Series

The PT2245PW Series is a 21.5" flat panel screen with an active matrix, thin-film transistor (TFT) edge-lit LED LCD.

This unit is to be used as commercial and light industrial equipment only.

Features include:

- Analog signal input
- Dual digital signal inputs (HDMI® & DP)
- Active matrix TFT LCD technology
- 1920 x 1080 resolution
- 21.5" viewable display area - 16:9 aspect ratio
- 31.47 ~ 82.3 KHz horizontal scan
- 56 ~ 75 Hz high refresh rate
- 0.24795mm x 0.24795mm pixel pitch
- Auto adjustment function
- Multilingual OSD user control
- 100 mm VESA mount
- Removable base for flexible mounting solutions.
- Touch screen with USB controller
- Built-in audio: 3Wx2

Touch Screen for PT2245PW

- Number of Touch Points: 10
- Projected Capacitive touch screen for finger input only
- Surface: Glare treatment
- Interface: USB controller
- Transmittance: $\geq 85\%$
- HID Compliant: Windows® 11, 10, 8, 7, Linux, Android
- Driver: XP, XP Embedded

Package Overview

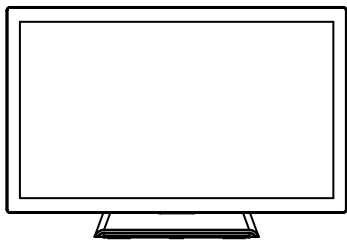

LCD Display

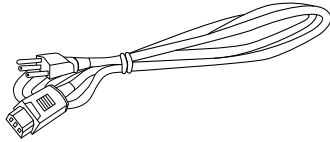

Power Cord

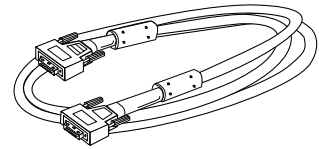

VGA Signal Cable

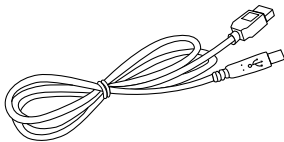

USB Cable (A to B)

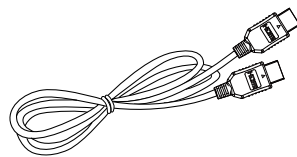

HDMI® Cable

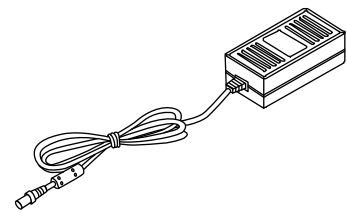

DC Power Supply

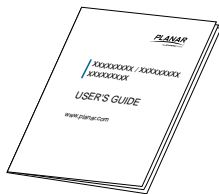

User's Guide



Landing Strip

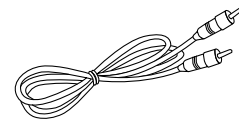

Audio-in Cable



Cable Cover Screw

Installation

Product Overview

- Front View

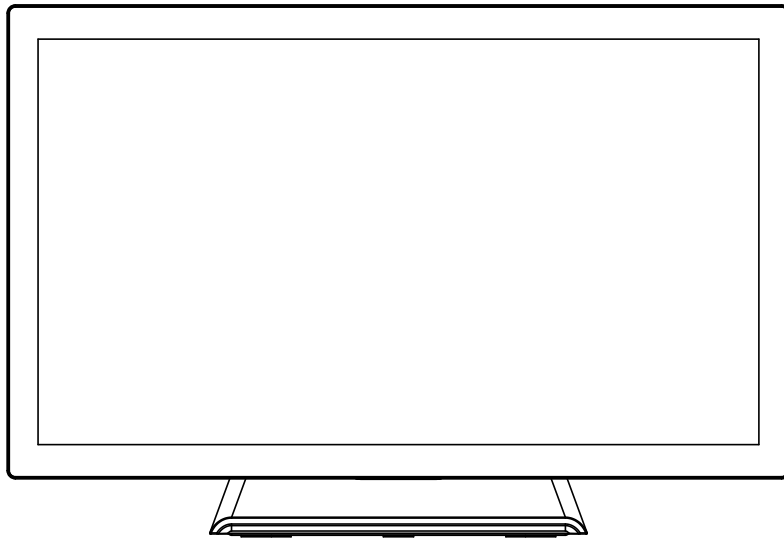

- Bottom View (Without Stand)

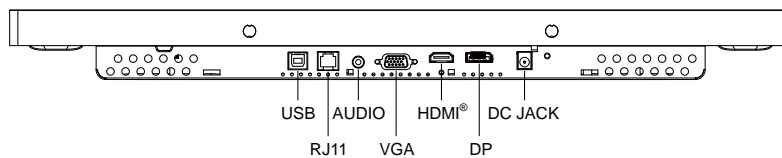

Warning! RJ11 port connect to remote key only

VESA Mount for Your Monitor

This monitor conforms to the VESA Flat Panel Mounting Physical Mounting Interface standard which defines a physical mounting interface for flat panel monitors, and corresponding with the standards of flat panel monitor mounting devices, such as wall and table arms. The VESA mounting interface is located on the back of your monitor.

To mount the monitor on a UL certified swing arm or other mounting fixture, follow the instructions included with the mounting fixture to be used.

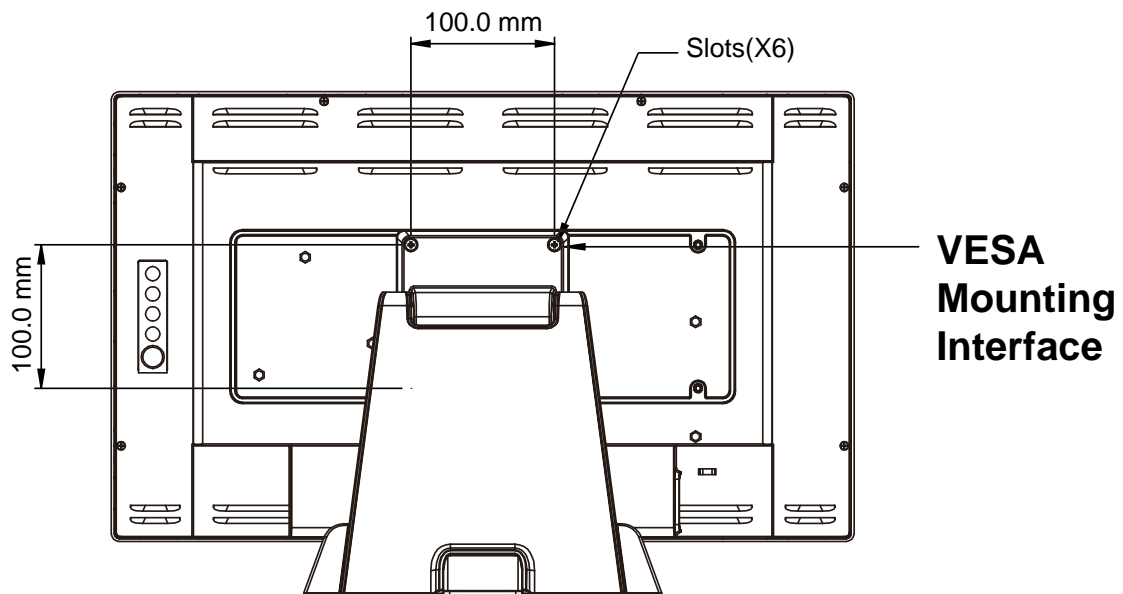

Notice!

Please select the proper screws!

The distance between the back cover surface and the bottom of the screw hole is 8 mm. Please use four M4*16 screws diameter with proper length to mount your monitor.

Please note: the mounting stand must be able to support at least 17.6 lbs (8Kg).

Start Your Installation

Please follow these instructions so that you can hook up the cables to associated connectors.

1. Lay the display flat on an even surface.
2. Move the stand into position as seen in the step 1 diagram.
3. Remove the cable cover as seen in the step 2 diagram.
4. Connect the cables to the appropriate connectors as seen in the step 3 diagram.
5. Re-attach the cable cover. Take the screw (CBM M3x6) out of the accessory box, and insert the screw into the cable cover and monitor as seen in the step 4 diagram.

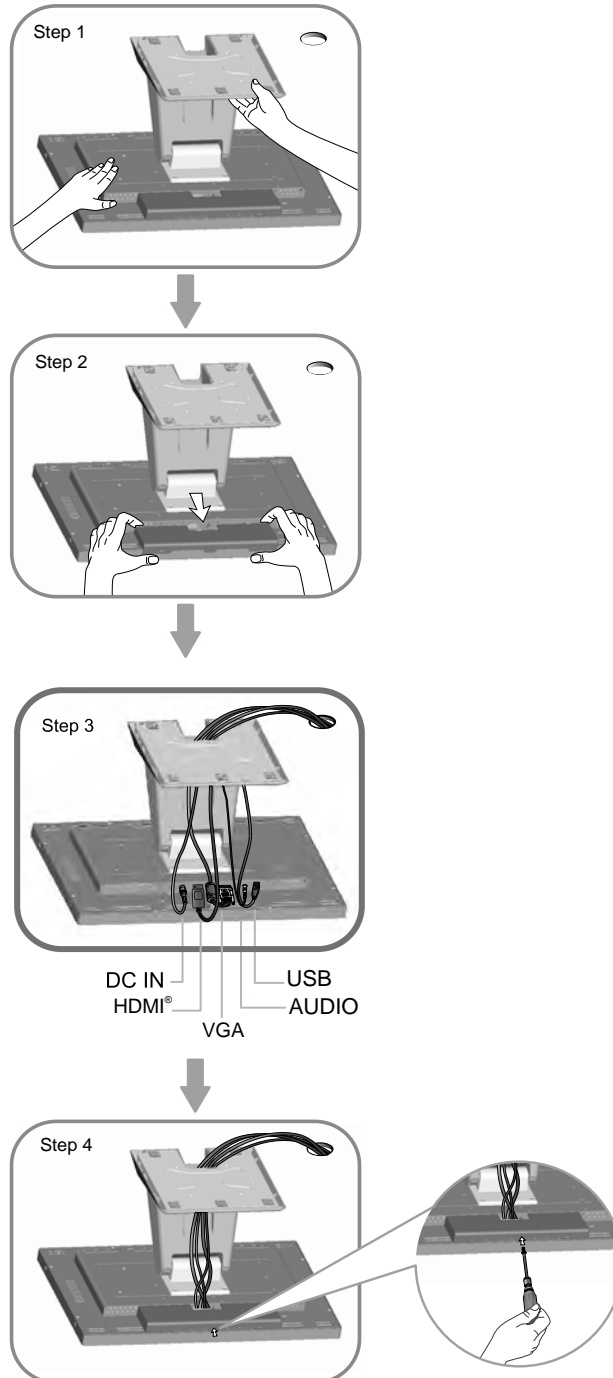

Connecting the Display (Figure 9.1)

To setup this display, please refer to the following figure and procedures.

1. Be sure all equipment is turned off.
2. Connect the DC plug to the power connector on the monitor and the other end into an electrical outlet (9.1).
3. Connect the HDMI[®], DP or VGA cable from the display's HDMI[®], DP or VGA input connector to the HDMI[®], DP or VGA connector of your host computer and tighten the screws (9.1).
4. If using VGA, connect the audio-in cable from the audio input port of your display to the audio out port of your computer (9.1).
5. Connect the USB cable from the USB port of your display to the USB port (9.1) of your computer.
6. Configure the touch screen. Refer to the "Touch Screen Driver Installation" section on page 19.
7. Once the touch screen is configured, the monitor is ready for use.

Notice!

To ensure the display works well with your computer, please configure the display mode of your graphics card to make it less than or equal to 1920 x 1080 resolution and make sure the timing of the display mode is compatible with the LCD display.

We have listed the compatible "Video Modes" of your LCD display in the appendix (on page 18) for your reference.

Applicable external power supply: Delta/ADP-50YH B

(Figure 9.1)

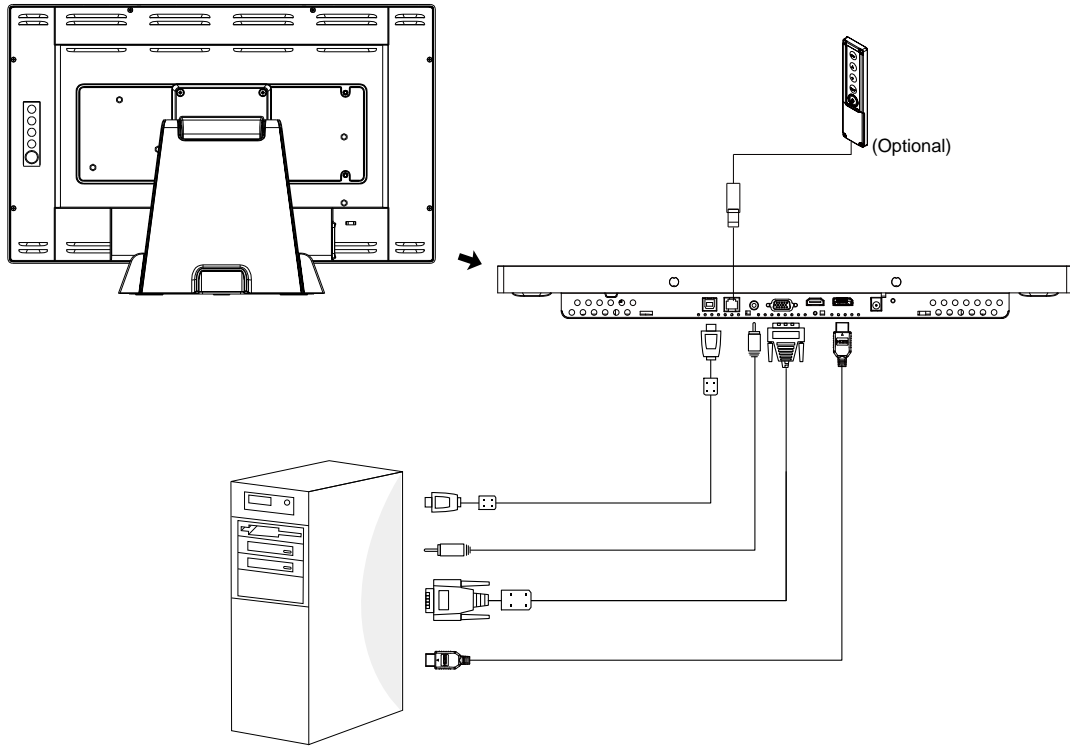



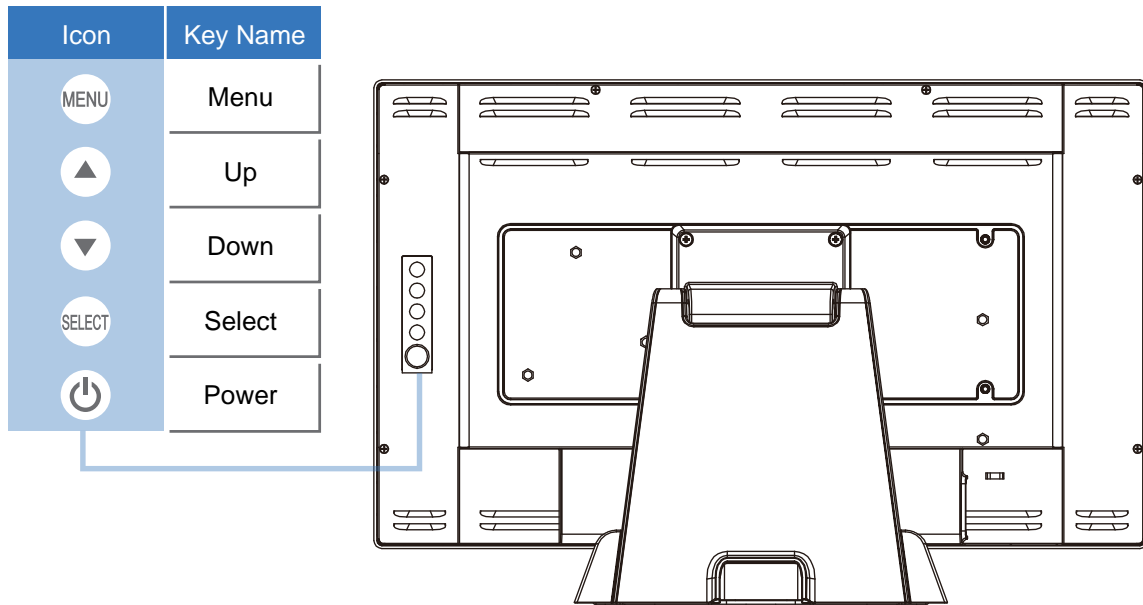

User Controls

Side Panel Controls



OSD Key	Menu off status	Menu on status
MENU	Menu appear	Exit. Returns to previous menu or exits OSD.
▲	Brightness	Main item select up / Adjust up
▼	Mute	Main item select down / Adjust down
SELECT	Source	Select or Enter. Proceeds to next menu or confirms selection.
⏻	Power On / Off	

How to use OSD menus

Icon	Key Name
	Menu
	Up
	Down
	Select
	Power

How to Operate OSD

1. Press the “MENU” button to pop up the “on-screen menu”
2. Press “Up” or “Down” button to navigate in the main menu and sub menu.
3. Choose the adjustment items by pressing the “SELECT” button.
4. Adjust the value of the adjustment items by pressing the “Up” or “Down” button
5. Press “SELECT” to Enter, press “MENU” to exit.
6. The OSD menu will automatically close, if left idle for a pre-set time.

Lock/Unlock OSD/Power buttons

1. To Lock or Unlock the OSD / Power buttons, press “Menu” and “Down” at the same time. This will activate an OSD window as follows:



2. Choose to activate OSD or Power Key lock. Choose Yes or No to lock or unlock.

Note:

When the OSD Key function is locked, all the buttons except “power” button are now disabled. When the Power Lock function is locked, the power key is disabled. User cannot turn off the monitor by “Power” key.

Enable/Disable Touch Function

1. To disable the touch function, press “Menu” and “Enter” Key, at the same time.
2. To enable the touch function, press “Menu” and “Enter” Key, at the same time for five seconds.

Powering off the monitor

Powering off the monitor requires 3 presses to the power key. This is designed to prevent accidental power off.

1. Press the power key once, an OSD window will pop up “Do you want to turn off”.
2. Press the power key again. Another OSD window will pop up “Please press the power button again”
3. Press the power key one last time to turn off.
4. If you do not press the power key in five seconds, the OSD window will be gone and return to the normal status instead.

Source Select

During On mode: Pressing “Select” key for 3 seconds, will pop up “source select” OSD.

During Sleep Mode: Pressing “Select” key for 1 seconds, will pop up “source select” OSD.

Factory Mode

This mode is reserved for maintenance.

On-Screen Display Menus

Main OSD Menu:

ITEM	CONTENT
Contrast	The monitor luminance level control.
Brightness	The monitor backlight level control.
H-Positon	Moving screen image horizontal position to left or right.
V-Positon	Moving screen image vertical position to up or down.
Phase	The screen image horizontal dot clock adjustment.
Clock	The screen image pixel phase adjustment.
Auto Adjust	Fine-tune the image to full screen automatically.
Color Temp	Color temperature selection. (9300K, 6500K, 5500K, 7500K, User)
Sharpness	Adjust the screen sharpness.
OSD Timeout	OSD auto-disappear time selection.
OSD Positon	Moving OSD menu position.
OSD H-Positon	Moving OSD menu horizontal position to left or right.
OSD V-Positon	Moving OSD menu vertical position to up or down.
Reset	Factory default value restored.
OSD Language	OSD menu language selection. (English, French, Deutsch, Italian, Spanish, Japanese, Traditional Chinese and Simplified Chinese)
Source Sele	Select Input function.(Auto, VGA,HDMI [®] ,DP)
Display port	Display current resolution related information.
Volume	Audio volume adjustment.
Mute	Audio On/Off control.
Factory	Factory mode related adjustment items.

Appendix

Troubleshooting

If you are experiencing trouble with the display, refer to the following. If the problem persists, please contact your local dealer or our service center.

Problem: No image appears on screen.

- ▶ Check that all the I/O and power connectors are correctly and well connected as described in the “Installation” section.
- ▶ Make sure the pins of the connectors are not crooked or broken.

Problem: Partial Image or incorrectly displayed image.

- ▶ Check to see if the resolution of your computer is higher than that of the display.
- ▶ Reconfigure the resolution of your computer to make it less than or equal to 1920 x 1080.

Problem: Image has vertical flickering line bars.

- ▶ Use “Horizontal size” to make an adjustment.
- ▶ Check and reconfigure the display mode of the vertical refresh rate of your graphic card to make it compatible with the display.

Problem: Image is unstable and flickering

- ▶ Use “Fine” to make an adjustment.

Problem: Image is scrolling

- ▶ Check and make sure the VGA signal cable (or adapter) is securely connected.
- ▶ Check and reconfigure the display mode of the vertical refresh rate of your graphics card to make it compatible with the display.

Problem: Vague image (characters and graphics)

- ▶ Use “Horizontal size” to make an adjustment. If this problem still exists, use “Fine” to make an adjustment.

Warning Signal

If you see warning messages on your screen, this means that the display cannot receive a clean signal from the computer graphics card.

Below are the three kinds of Warning Signal. Please check the cable connections or contact your local dealer or our service center for more information.

No Signal

This message means that the display has been powered on but it cannot receive any signal from the computer graphics card. Check all the power switches, power cables, and VGA/DVI signal cable.

Going to Sleep

The display is under the power saving mode. In addition, the display will enter power saving mode when experiencing a sudden signal disconnecting problem.

The monitor can be activated by pressing any keyboard, triggering the mouse or touching the screen.

Out of Range

This message means that the signal of the computer graphic card is not compatible with the display. When the signal is not included in the "Video Modes" list we have listed in the Appendices of this manual, the monitor will display this message.

Product Dimensions

► Front View

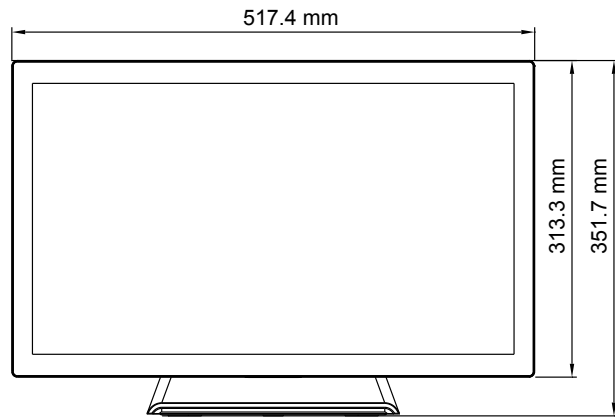

► Side View

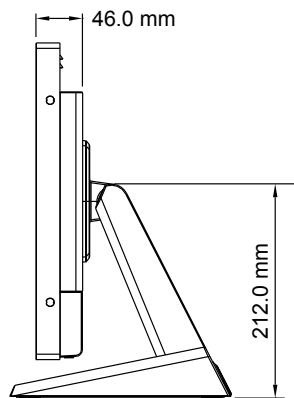

► Top View

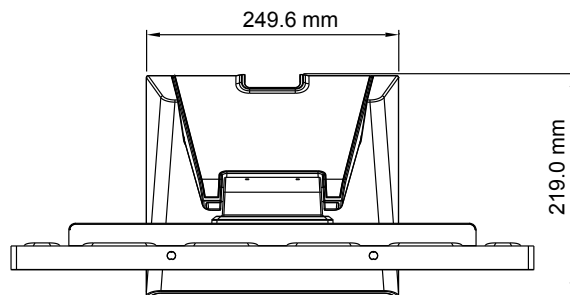

Rotate

► Front View

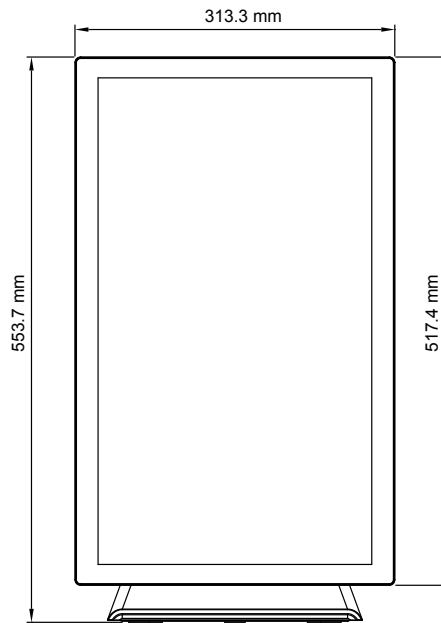

► Side View

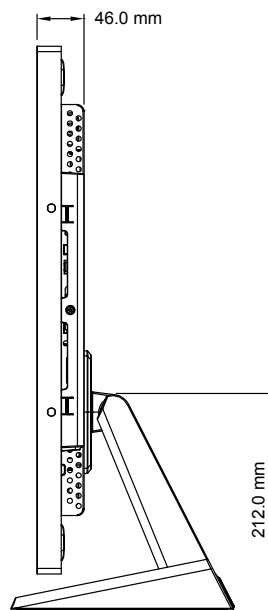

► Top View

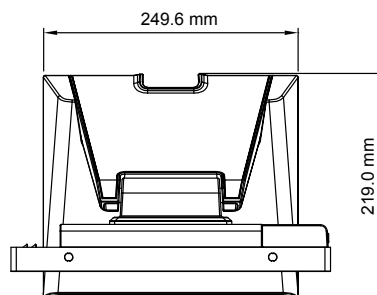

Compatibility Modes

Mode	Resolution	H-Frequency(khz)	V-Frequency(hz)
IBM VGA	720X400	31.47	70
IBM VGA	640X480	31.47	60
Apple MacII	640X480	35.00	66
VESA VGA	640X480	37.86	72
VESA VGA	640X480	37.50	75
VESA SVGA	800X600	35.16	56
VESA SVGA	800X600	37.88	60
VESA SVGA	800X600	48.08	72
VESA SVGA	800X600	46.88	75
Apple Mac	832X624	49.72	75
VESA XGA	1024X768	48.36	60
VESA XGA	1024X768	56.48	70
VESA XGA	1024X768	60.02	75
VESA SXGA	1280X1024	64.00	60
VESA SXGA	1280X1024	80.00	75
VESA SXGA	1152X864	67.50	75
VESA SXGA	1280X960	60.00	60
WXGA+	1440X900	56.00	60
WXGA+	1440X900	70.60	75
WSXGA+	1680X1050	65.20	60
WSXGA+	1680X1050 (VGA only)	82.30	75
VESA WXGA	1280X768	47.776	60
WSXGA+	1920X1080	67.50	60

Touch Screen Driver Installation

PT2245PW Calibration Instruction:

Calibrating the touch screen in Windows 7/8/10/11:

1. Tap the Start button, Control Panel and then Hardware and Sound.
2. Under Tablet PC Settings, tap Calibrate the screen for pen or touch input.
3. On the Display tab, under Display options, tap Calibrate and then Yes to allow the program to make changes.
4. Follow the on-screen instructions to calibrate the touch screen.

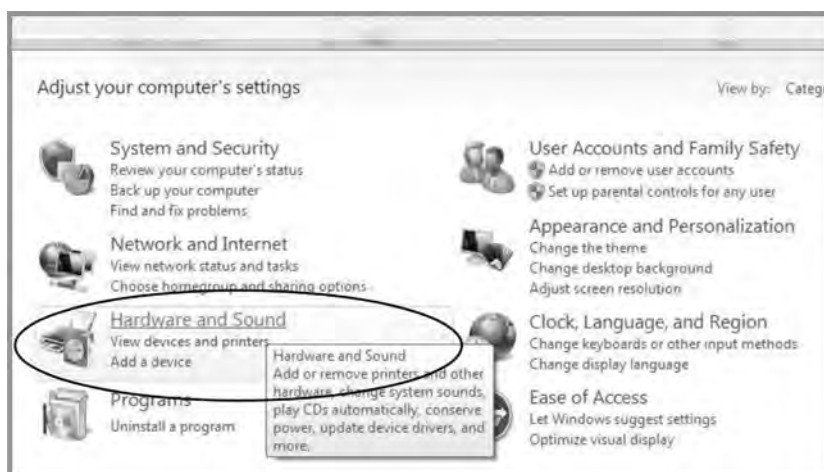

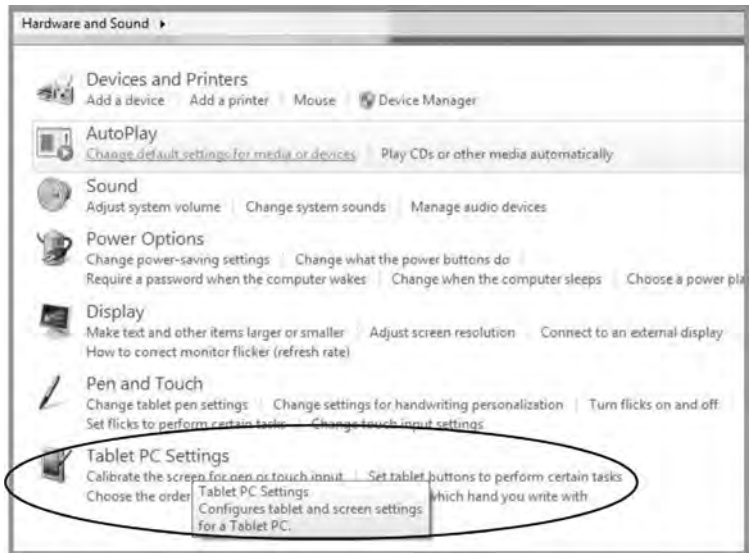

PT2245PW Install Instruction:

If you are using a PC running Windows® 7/8/10/11, VISTA, XP, 2000, 98, NT4.0, follow the instructions below:

1. Power on the PC.
2. Be sure the USB cable is connected from the PC to the display.
3. Visit www.planar.com/support.
4. Follow the step-by-step instructions as shown on the pop-up windows.

If you are using a PC running driver Linux kernel 2.x.x / 3.x.x / 4.x.x / 5.x.x (32 bit & 64 bit), follow the instructions below:

1. Power on the PC.
2. Be sure the USB cable is connected from the PC to the display.
3. Visit www.planar.com/support.
4. Follow the step-by-step instructions as shown on the pop-up windows.

If you are using a PC running Windows® XP Embedded, follow the instructions below:

Express:

1. Power on the computer.
2. Make sure that the USB cable is connected to the computer.
3. Be sure that your EWF is disabled. If your EWF is enabled, please disable the EWF by using the EWF Manager command.
4. Once the EWF is disabled click on the XP driver at www.planar.com/support. and follow the step-by-step instructions as shown on the pop-up windows.

Custom:

1. Power on the computer.
2. Make sure that the USB cable is connected to the computer.
3. Follow the step-by-step instructions found in the zipped file at www.planar.com/support.

If you are using a PC running Windows® CE, follow the instructions below:

1. Power on the computer.
2. Make sure that the USB cable is connected to the computer.
3. Using Platform Builder, build an image file by following the step-by-step instructions found in the zipped file at www.planar.com/support.

If you are using a PC running Linux follow the instructions below:

1. Power on the computer.
2. Make sure that the USB cable is connected to the computer.
3. Follow the step-by-step instructions found in the zipped file at www.planar.com/support.

Technical Support

Cables and Accessories

To find cables and accessories for your Planar monitor, touch screen or other Planar products visit our online store at **www.PlanarOnline.com**.

Technical Support

Visit Planar at **<http://www.planar.com/support>** for operations manuals, touchscreen drivers, warranty information and access to Planar's Technical Library for online trouble shooting.

To speak with Planar Customer Support please have you model and serial number available and dial:

Planar Support

Tel: 1-866-PLANAR1 (866-752-6271) or +1 503-748-5799 outside the US.

Hours: 24 hours a day, 7 days a week.

Toll or long distance charges may apply.

European Product Database for Energy Labeling (EPREL)

PT2245PW Registration number: 716120

Planar Systems, Inc.

Customer Service

24x7 Online Technical Support: <http://www.planar.com/support>

Planar address: 1195 NE Compton Drive Hillsboro, OR 97006 USA

Tel: 1-866-PLANAR1 (866-752-6271) or +1 503-748-5799 outside the United States.

Hours: 24 hours a day, 7 days a week

© 05/2024 Planar Systems, Inc.

Planar is a registered trademark of Planar Systems, Inc. Other brands and names are the property of their respective owners. Technical information in this document is subject to change without notice.

8204221A0602

