

- NOTES:
1. SHEET METAL HOUSING IS EG PLATED.
 2. SOLID MODEL AVAILABLE UPON REQUEST.
 3. PART IS RoHS COMPLIANT.

REVISIONS				
ZONE	REV.	DESCRIPTION	DATE	APPROVED
	A	INITIAL RELEASE	08/03/07	RD

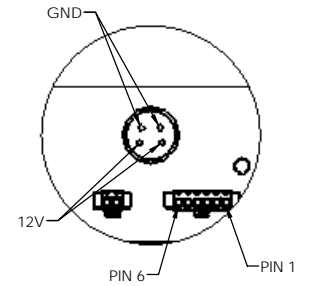
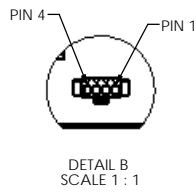
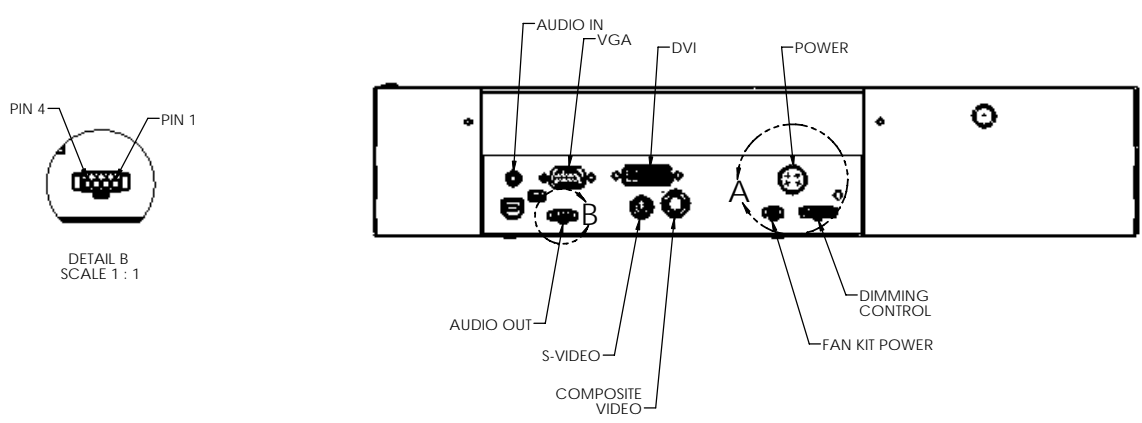
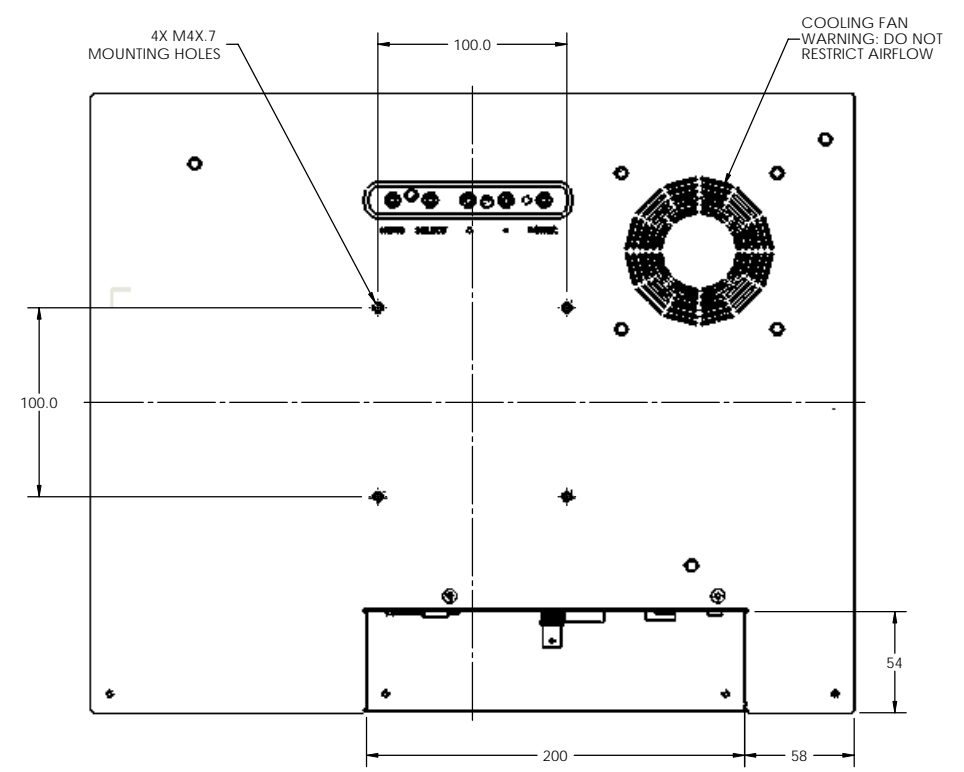
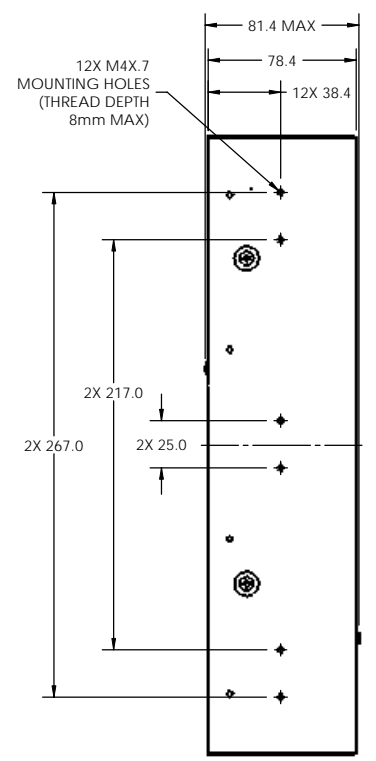
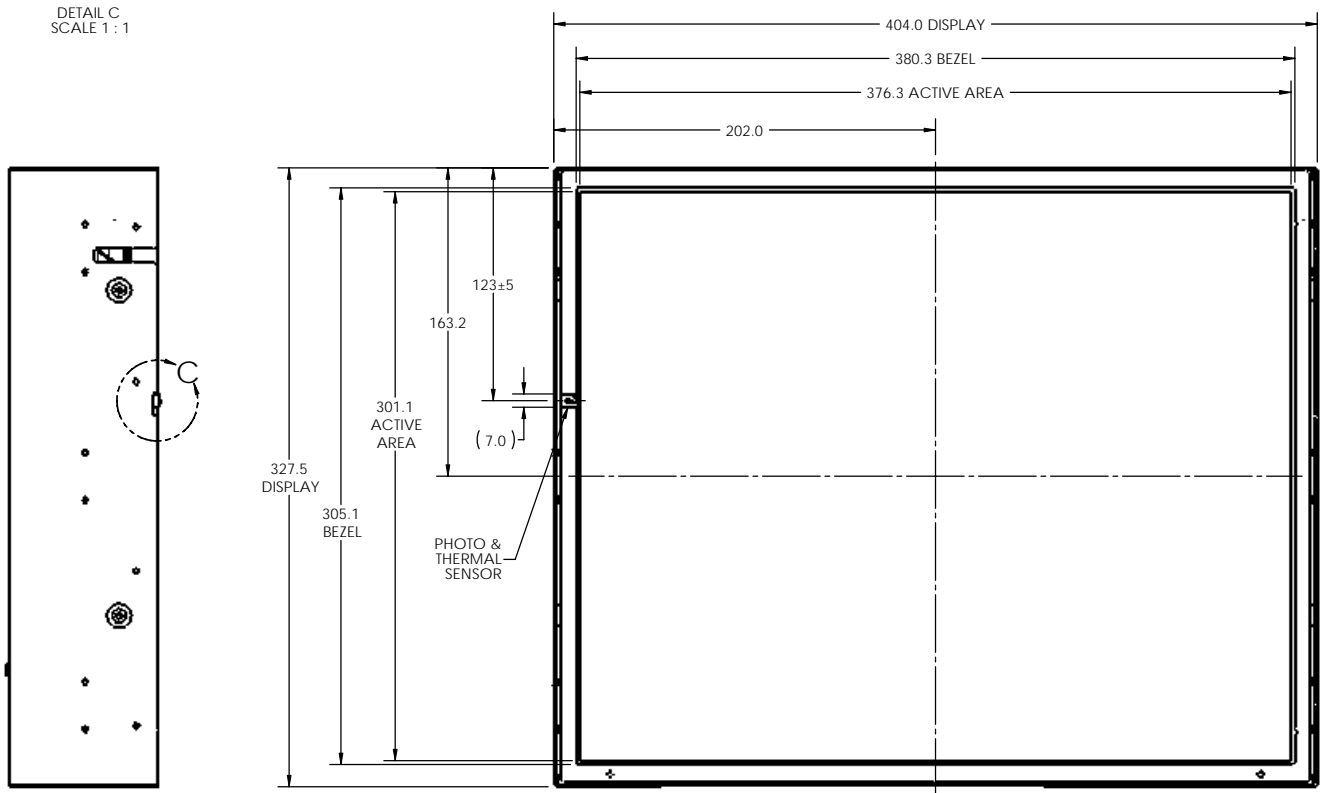
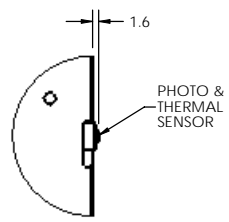
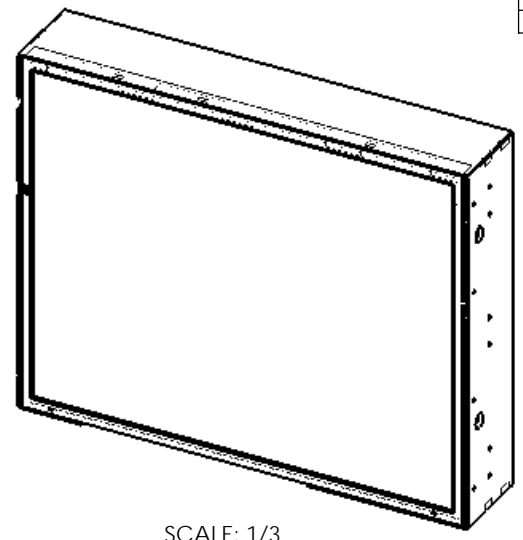

UNLESS OTHERWISE SPECIFIED, DIMENSIONS ARE IN MILLIMETERS.		DESIGNED BY	-	DATE	-
TOLERANCES:		DRAWN BY	R.DAVENPORT	06/14/07	
X= ±1	XX= ±25	CHECKED BY	-		
.X= ±.5	ANGLES= ±1°	USED ON	-		
DIMENSIONING AND TOLERANCING PER ASME Y14.5M 1994		MATERIAL	NA	TITLE	
THIRD ANGLE PROJECTION		FINISH	NA	DWG, SPEC, MECH O/L LC1913R	
		SIZE	D	PART NUMBER	997-3360-00LF
		DRAWING NO.	076-0627-00	REV	A
		SCALE	1:2	DO NOT SCALE	SHEET 1 OF 1

THIS DRAWING CONTAINS INFORMATION PROPRIETARY TO PLANAR SYSTEMS, INC. ANY REPRODUCTION IN PART OR WHOLE WITHOUT THE WRITTEN PERMISSION OF PLANAR SYSTEMS IS PROHIBITED. THIS DRAWING IS SUPPLIED FOR INFORMATION, IDENTIFICATION, ENGINEERING, EVALUATION, AND/OR INSPECTION PURPOSES ONLY AND MAY NOT BE USED AS A BASIS FOR THE MANUFACTURING OF PRODUCTS OR FOR THE FURNISHING OF SERVICES TO PLANAR SYSTEMS OR TO ANY THIRD PARTY UNLESS AUTHORIZED IN WRITING BY PLANAR SYSTEMS.