



LC17 AND LC19 SERIES
High-Brightness LCD Monitors

USER'S GUIDE

www.planar.com

The information contained in this document is subject to change without notice. This document contains proprietary information that is protected by copyright. All rights are reserved. No part of this document may be reproduced, translated to another language or stored in a retrieval system, or transmitted by any means, electronic, mechanical, photocopying, recording, or otherwise, without prior written permission.

Windows® is a registered trademark of Microsoft, Inc.

Other brands or product names are trademarks of their respective holders.

European Union 2002/95/EC Directive on the Restriction of Hazardous Substances (RoHS)

In February 2003, the European Union issued Directive 2002/95/EC on the Restriction of Hazardous Substances, commonly known as RoHS, in certain electrical and electronic equipment. It restricts the use of six hazardous substances, including lead (Pb).

The Directive states that all new products within its scope, placed on the European market after July 1, 2006 must be compliant with its requirements.

Planar Systems Inc. is fully in support of and compliant with EU Directive 2002/95/EC for applicable products within its scope.

A Planar part number will be modified with an "LF" suffix designation to indicate RoHS compliance, as shown on the part number label affixed to the display and on the box containing the display.

Important Recycle Instruction:



LCD Lamp(s) inside this product contain mercury. This product may contain other electronic waste that can be hazardous if not disposed of properly. Recycle or dispose in accordance with local, state, or federal Laws. For more information, contact the Electronic Industries Alliance at [HYPERLINK "http://WWW.EIAE.ORG"](http://WWW.EIAE.ORG) WWW.EIAE.ORG For lamp specific disposal information check WWW.LAMPRECYCLE.ORG.

Table of Contents

Usage Notice	
Safety and Use Precautions	4
Introduction	
About the LC17 and LC19	5
Package Overview	6
Installation	
Product Overview	7
Connector Descriptions	8
Mounting	9
Start Your Installation	10
User Controls	
Control Buttons	11
How to Use the OSD Menu	12
On-Screen Display Menu	13
Brightness Control	
Automatic Brightness Control	14
Manual Brightness Control	15
Minimum Brightness Limit	17
Maximum Brightness Mode	18
Specifications	
Electrical and Optical	19
Mechanical and Environmental	20
Audio	20
Video Compatible Modes	20
Reliability and Life	21
Safety and Regulatory Certifications	21
Available Options and Replacement Components	
Power Supply and AC Power Cord	22
Cooling Kit	23
IR Touchscreen	24
Capacitive Touchscreen	25
Appendix	
Troubleshooting	26
Warning Signal	26
Mechanical Outline	27
Support and Service	28

Usage Notice

WARNING - To prevent the risk of fire or shock hazards, do not directly expose this product to rain or moisture.

WARNING - Please do not open or disassemble the product as this may cause electric shock.

Safety and Use Precautions

Follow all warnings, precautions and maintenance as recommended in this User's Manual to maximize the life of your monitor.

- Turn off the product before cleaning.
- Use only a dry soft cloth or clean room wiper when cleaning the LCD panel surface.
- Use a soft cloth moistened with mild detergent to clean the monitor housing.
- Use only a high-quality and safety-approved 12V power supply.
- Do not touch the LCD panel surface with sharp or hard objects.
- Do not use abrasive cleaners, waxes or solvents for cleaning.

Introduction

About the LC17 and LC19

The LC17 and LC19 are high performance monitors designed for demanding applications. The monitor consists of a 17" or 19" diagonal flat panel liquid crystal display (LCD) housed in a metal enclosure with an integrated ambient light sensor to facilitate automatic brightness control.

Features Include:

- Very high bright 1100+ cd/m² brightness for sunlight readability
- Automatic brightness control to auto adjust the brightness to ambient conditions
- Manual brightness control mode to allow the user to control the brightness
- Wide 0°- 50°C operating temperature range
- Long backlight life: 50,000 hours operating time before reaching half brightness
- Rugged vibration and shock characteristics
- Conformance to FCC/EN55022 Class B for low EMI
- 1280 x 1024 SXGA resolution (native mode)
- Auto-adjustment function for jitter-free operation
- Optional cooling kit to reduce solar loading on LCD surface
- Optional IR touchscreen with clear glass overlay. Other touchscreens available upon request.

Package Overview

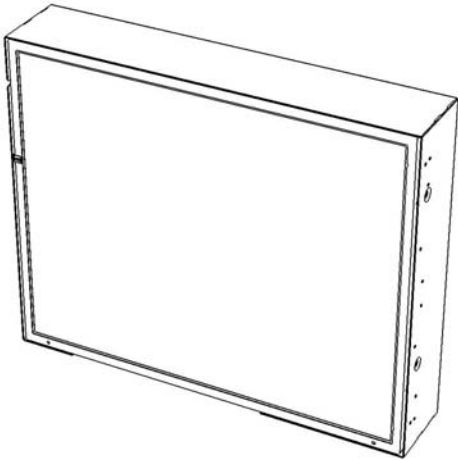

LC17/LC19

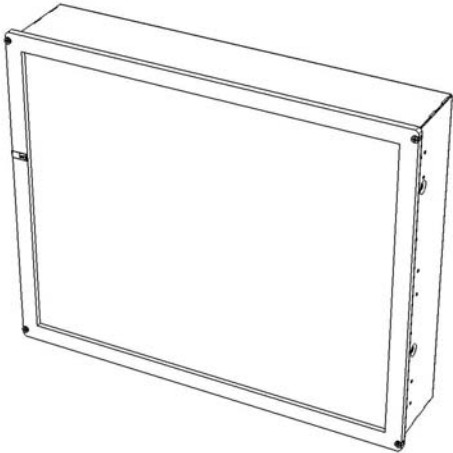

LC17/LC19 with IR Touchscreen

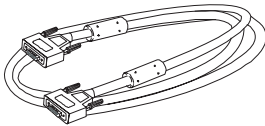

VGA Signal Cable

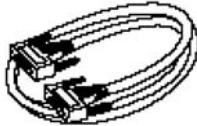

DVI-D Signal Cable

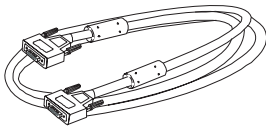

S-Video Cable

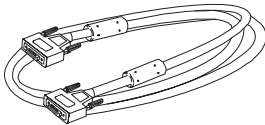

Composite Video Cable



Quick Start Guide

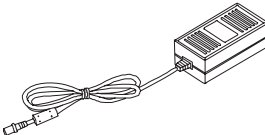

80W Power Adapter

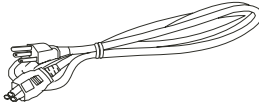

North America Power Cable

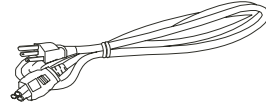

European Power Cable

Installation

Product Overview

- Front View



- Rear View

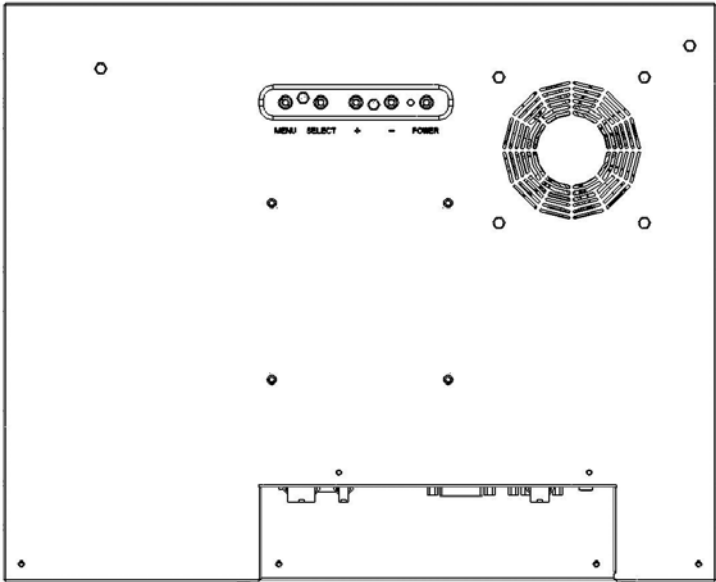

Connector View

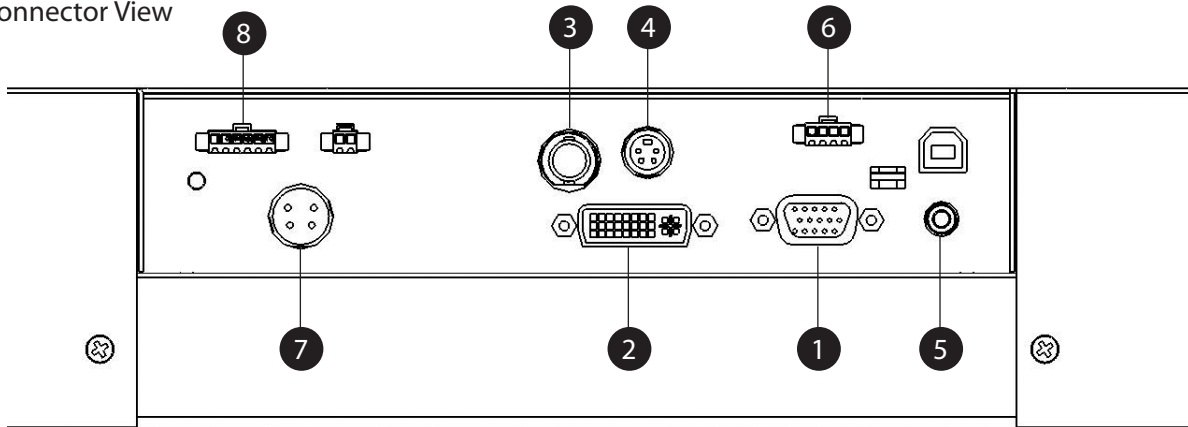

Connector Descriptions

1. Video Interface Connector - Standard D-sub Analog; 15-pin D-sub connector
2. DVI-D
3. NTSC/PAL BNC connector 75 ohm input, female composite
4. S-Video input
5. Audio Input - 5P ST/LEAD A71-5AYLT1 LINE, 1.059F2.014
6. Audio Output - SMP-04V-BC Black (Manufacturer is JSP)
7. Power Input Connector

Connector type: 4-pin mini DIN socket

Manufacturer: Singatron Enterprise Co. (Taiwan)

Part Number: 2MJ-0402A120

Mating Connector: 2MP-0402 series

Power Connector Pin Configuration

Pin	Description
1	+12V DC
2	+12V DC
3	Ground
4	Ground

8. External Dimming Connector

Connector type: JST SMP-06V-BC

Mating connector: JST SMR-06V-B

Socket Contact: SHF-001T-0.8BS

Pin Contact: SYM-001T-P0.6

External Dimming Connector Pin Configuration and Description

Pin	Name	Description
1	Ground	Electrical ground
2	Reserved	For factory use only, leave unconnected
3	DIM_Input	0-5V analog input for external dimming, connect to wiper of dimming pot if used
4	/Ext_DIM,	Input to determine brightness control mode; has 10k pull up to +5V Logic high (or unconnected) = Automatic Brightness Control mode Logic low = Manual Brightness Control mode
5	Ground	Electrical ground; connect to lower leg of dimming potentiometer if used
6	Vref	+5V reference voltage output with 470 ohm series resistance; connect to upper leg of dimming potentiometer if used

9. Cooling Kit Power Output Connector

NOTE: There is no need to connect to this connector. Information is shown for reference only.

If a Cooling Kit option is ordered, the required cooling kit power cable will be installed at the factory.

Optional Cooling Kit Pin Configuration

Pin	Description
1	Switched Return
2	+12V output

Mounting

The LC17 and LC19 can be mounted in two manners: rear 100 mm VESA mount and side mounting holes. M4 threaded holes are provided in the sides of the monitor housing for mounting purposes. The blind holes will accommodate 10 mm long screws. See the mechanical outline drawing (LC17: 076-0626-00 and LC19: 076-0627-00) at www.planar.com/support for details.

Start Your Installation

Connecting the Display (Figure 1.0)

To configure the monitor, please refer to the following figure and procedures.

1. Be sure the computer or video source is turned off.
2. Connect the 12V DC power(1.0). During initial turn on with no video applied, the display will automatically power on with a self test pattern displayed. The self test pattern consists of alternating screens of black, white, red, green, and blue.
3. Connect the video signal from your signal source to the video input connector of your choice and tighten.
4. If needed, connect the external dimming cable connector and audio connectors(1.0). See details in the Brightness Control section of this document.
5. Turn on your computer or video source.

NOTE: Once video is applied, self test mode is automatically cancelled and will no longer function when video is removed.

NOTE: To optimize your image, please configure the display mode of your graphic card for a 1280 x 1024 resolution and a 75Hz refresh rate.



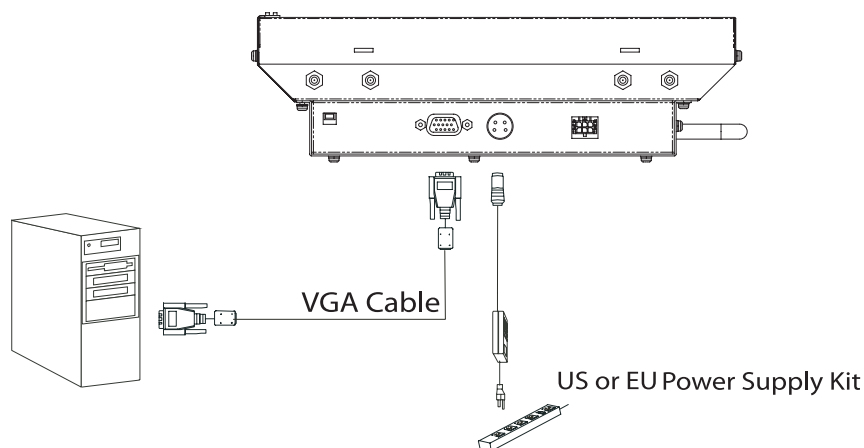



Figure 1.0

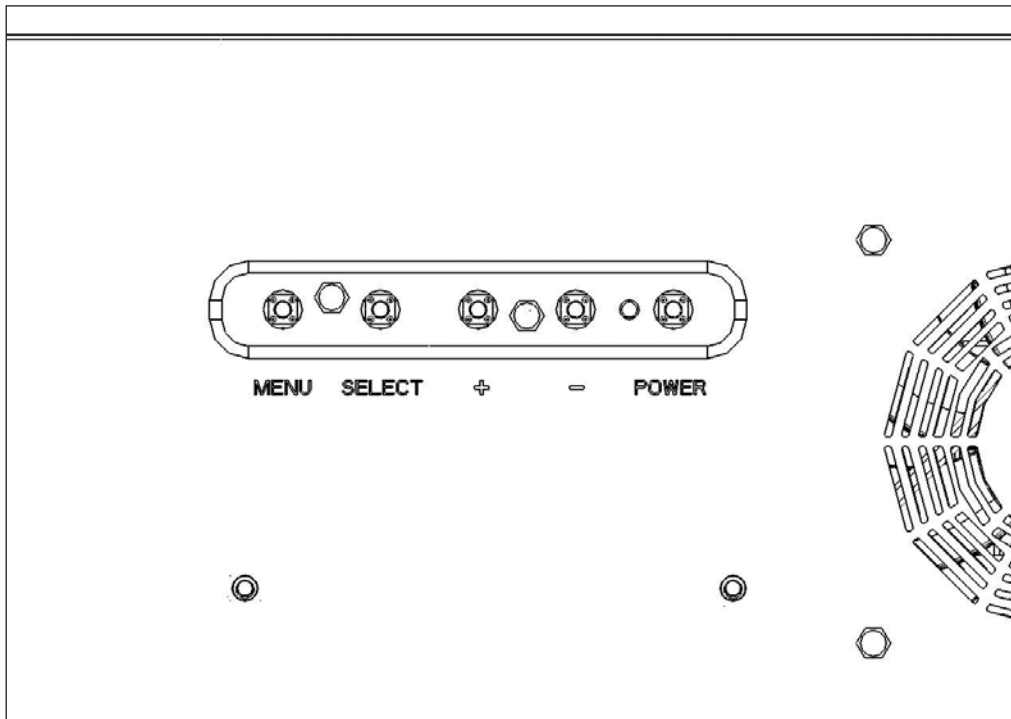

User Controls

Control Buttons



No./ Icon	Control	Function
	Menu button	Displays the OSD menu
	Select/Auto	<i>Select-</i> To select the adjustment items from OSD menus. <i>Auto-</i> To activate the Auto Adjustment function to obtain an optimum image.
	Brightness Minus/Minus	1. Decreases the value of the adjustment items. 2. Decreases the minimum brightness limit of the display image.
	Brightness Plus/Plus	1. Increases the value of the adjustment items. 2. Increases the minimum brightness limit of the display image.
	Power Switch	Switches on/off the power of the LCD display.
	Power LED	1.Green indicates the display is turned on. 2. Amber indicates the display in power-saving mode.

How to Use the OSD Menu

1. Press the "Menu" button to pop up the on-screen menu and to select between the four main menus.
2. Choose the adjustment items by pressing the "Select/Auto" button.
3. Adjust the value of the adjustment items by pressing the "+" or "-" button.
4. The OSD menu will automatically close if you have left it idle for a pre-set time.

On-Screen Display Menus

	Level 1	Level 2	Level 3	Level 4	Remark
Main Menu	Display	Brightness (Min Brightness Limit)	0-100		60
		Contrast	0-100		50
		Hue	-45 - +45		0
		Saturation	0-100		50
		Flesh-tone	Off, weak, soft, strong		off
		Black-Level (VGA only)	0-100		
	Image	Scaling	1:1		
			Full		v
			Aspect		
		Auto Adjust(VGA only)	Select		
		Phase(VGA only)	0-255		
		Clock(VGA only)	0-255		
		Sharpness(Video only)	0-9		3
	Position Control	Zoom	In		
			Out		
		Zoom Horizontal Pan	Left		
			Right		
		Zoom Vertical Pan	Up		
			Down		
	Color	SRGB	Off		v
			On		
		Gamma Correction	Off		v
			1.8		
Color Temperature	User	R	0-255		
		G	0-255		
		B	0-255		
	6500		v		
9300					
	PIP Control	PIP Mode	Off		v
			PIP		
			PAP		
		PIP Size	Small		v
			Med.		
			Large		
		Vertical	0-100		
Horizontal	0-100				
	Input Select	PIP source (press switch to Main source select)	VGA, DVI, Composite, S-Video		Composite
		Main source (press switch to PIP source select)	VGA, DVI, Composite, S-Video		VGA

Brightness Control

The brightness of the monitor may be controlled automatically or manually, and the minimum brightness is adjustable. By default, the monitor is configured for automatic brightness control with a minimum brightness setting of approximately 150 cd/m².

Automatic Brightness Control

In automatic brightness control mode, a photo sensor measures the ambient lighting condition (the illuminance). The monitor automatically and continually adjusts its brightness to accommodate the ambient environment. In moderately bright environments the monitor will reach maximum brightness. In dimly lit environments the monitor will operate at minimum brightness.

The graph below shows the factory set response to ambient lighting conditions. Note that a typical office environment is 300 to 500 lux, while a typical cloudy day is roughly 1000 lux.

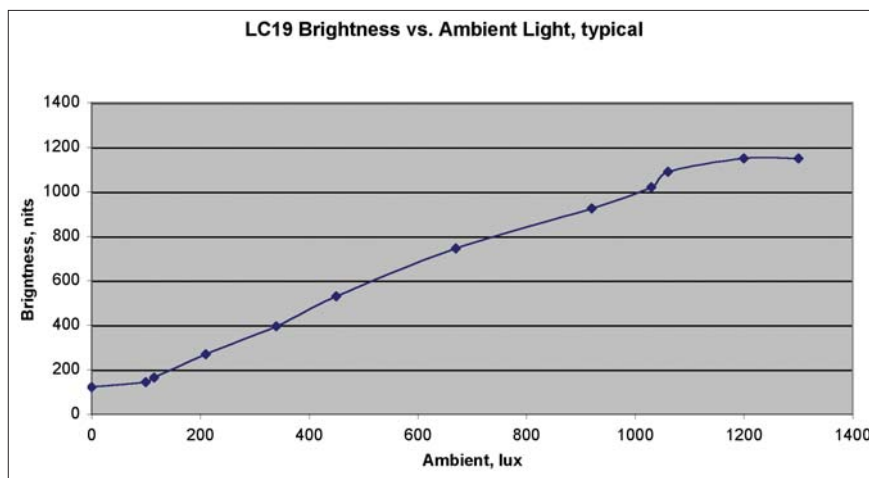
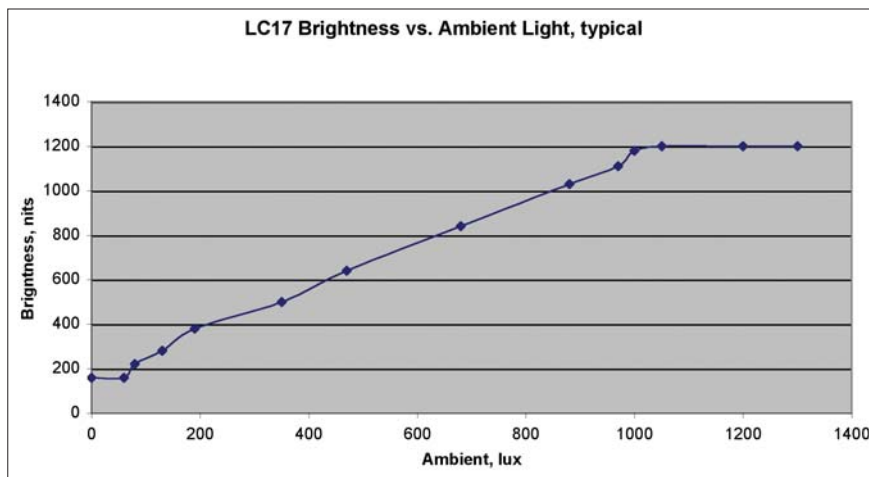

Automatic brightness control with remote photo sensor.

The schematic below is a reference design for the user to install the photo sensor remotely from the display.

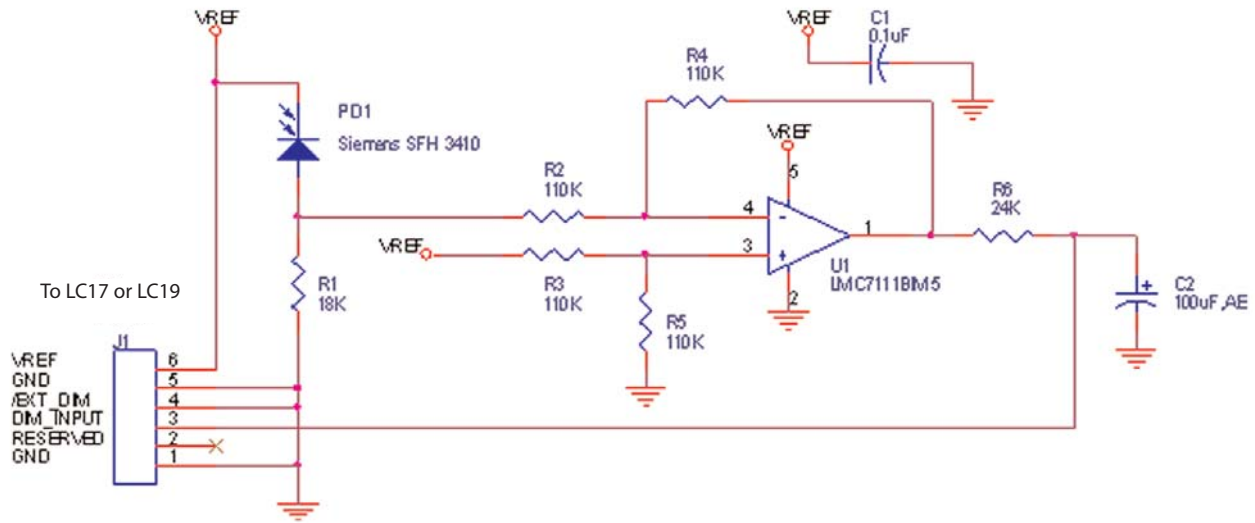

Reference Design for Remote Photo Diode Brightness Control

Manual Brightness Control

In manual brightness control mode, an externally supplied voltage determines the monitor brightness.

To use manual brightness control mode instead of the default automatic brightness control mode:

1. set pin 4 (/EXT_DIM) of the external dimming connector (J1) to a logic low
2. apply a 0 to 5V analog input to pin 3 (DIM_INPUT) of the external dimming connector

A potentiometer may be used to apply the voltage to the DIM_INPUT, as shown in the figure below. A 20k pot or higher is recommended. Note that VREF is a 5V regulated voltage supplied through a 470 ohm series resistance.

Important note! Do not connect to pin 2!

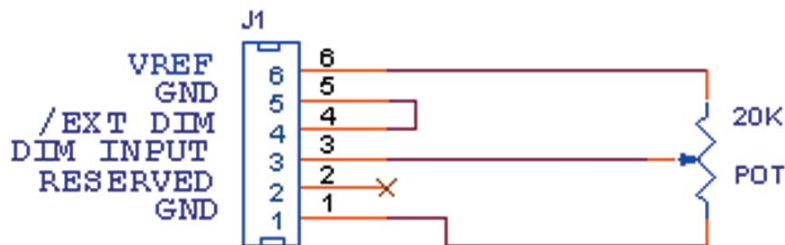

Manual brightness control using a potentiometer

The graph below shows the typical factory set response to the DIM_INPUT voltage when in manual brightness control mode.

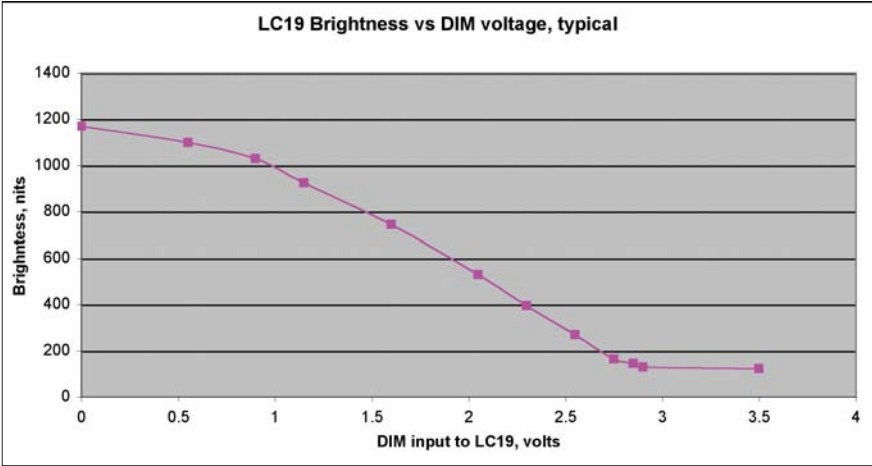
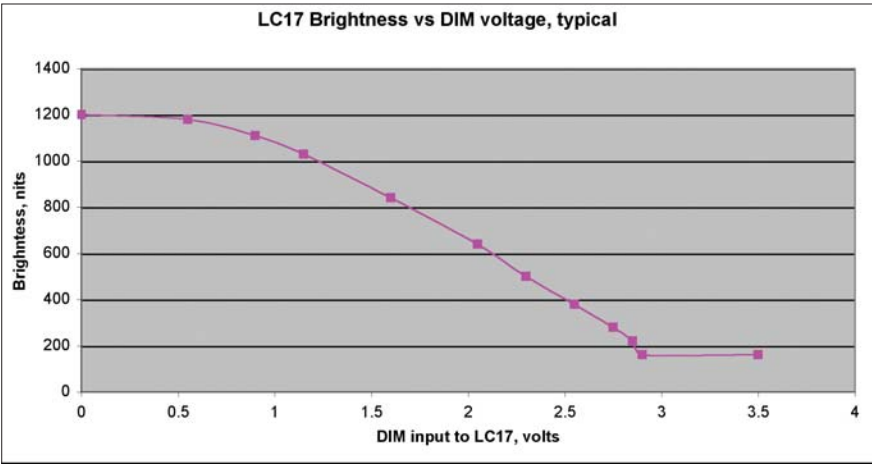

Minimum Brightness Limit

The factory set minimum brightness is approximately 150 cd/m². In most applications the factory setting is desired to maintain the widest dimming range possible. But for applications where 300 cd/m² is too low but some dimming is still desired, the minimum brightness limit may be increased. The OSD controls are used to access and change the minimum brightness limit setting, as described in the User Controls section of this manual.

Below is a graph showing the typical minimum brightness limit for a given OSD setting:

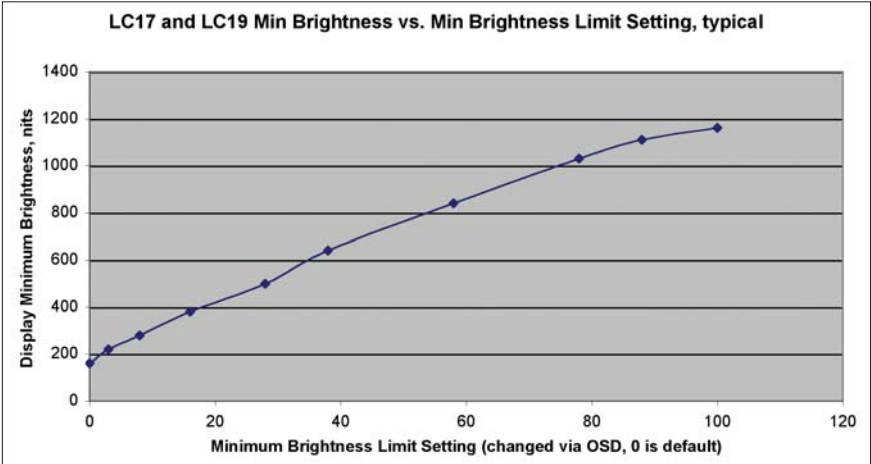

To change the minimum brightness limit, one of three basic methods can be used:

1. If one wishes to set an approximate minimum brightness, the above graph may be used. For instance, to set the minimum to approximately 500 cd/m², set the minimum brightness limit to an OSD setting of 30. Note, however, that there may be significant (+/- 50%) luminance variation for a given OSD setting due to display variation. Also note that decreasing the Minimum Brightness Limit from its factory-set value has no effect; only increasing the limit has an effect.
2. To set the minimum brightness visually, one may set the dimming to a minimum (by covering the photo sensor on the front of the monitor if in automatic brightness control mode, or by setting the DIM_INPUT to 5V if in manual brightness control mode) and then adjust the OSD setting to visually give the desired result.
3. To quantitatively set the minimum brightness to a desired luminance, one may set the dimming to a minimum and then adjust the OSD setting to give the desired result as measured by a photometer (such as the Tektronix J17 with a J1803 luminance head.) Note that a ten minute monitor warm up period with the monitor set near its minimum brightness is recommended to allow for an accurate measurement.

As with any OSD setting, a change to the minimum brightness limit will be permanently stored and will be unaffected by turning off the monitor power.

The minimum brightness limit will affect the minimum brightness of both the automatic brightness control mode and the manual brightness control mode identically. Below is a graph showing the impact of various minimum brightness limit settings on the automatic brightness control mode.

Maximum Brightness Mode

If a constant maximum brightness is desired, simply connect both the DIM_INPUT and the /EXT_DIM inputs of connector J1 to ground. The monitor will then be set to the maximum brightness.

Specifications

Electrical and Optical

SPECIFICATIONS	LC17 Series	LC19 Series
Planar Part Number	997-3361-00LF	997-3360-00LF
Display Type	Compensated TN, Full color TFT AMLCD	Compensated TN, Full color TFT AMLCD
Video Modes	SXGA (1280 x 1024), XGA, SVGA, VGA	SXGA (1280 x 1024), XGA, SVGA, VGA
Image Area	338mm x 270mm (17" diagonal)	396mm x 301mm (19" diagonal)
Video Input	DVI-D, 15-pin VGA, S-Video, Composite	DVI-D, 15-pin VGA, S-Video, Composite
Luminance (typical)	1100 cd/m ²	1150 cd/m ²
Contrast Ratio (typical)	500:1	500:1
Dimming Range	6:1	6:1
Viewing angle (typical)	140° H, V	140° H, V
Response Time (typical)	12 ms	20 ms
Power Consumption (typical)	50W	70W
Supply Voltage	+12VDC	+12VDC
Dimensions (w/o touchscreen) (WxHxD)	14.6" x 12.2" x 3.2" (370mm x 310mm x 80mm)	15.6" x 13.5" x 3.4" (376mm x 343mm x 80mm)
Weight (w/touchscreen)	10.0 lbs (4.5 kg)	11.3 lbs (5.12 kg)
Operating Temperature	0° to +50° C	0° to +50° C
Storage & Transport Temperature	-20° to +60° C	-20° to +60° C
Humidity	< 80% RH non-condensing	< 80% RH non-condensing
Regulatory & Safety	FCC Class A, CE, UL/cUL, TUV, RoHS	FCC Class A, CE, UL/cUL, TUV, RoHS
Cooling	Whisper quiet internal fan. Consult factory for external cooling options.	Whisper quiet internal fan. Consult factory for external cooling options.
Power Supply	80W external p/s included	80W external p/s included
Touchscreen	IR touch monitor p/n 997-3451-00LF	IR touch monitor p/n 997-3475-00LF
Mounting Features	Side/Rear Mounting Points	Side/Rear Mounting Points
Audio	1W per channel	1W per channel
Cables Provided	VGA, DVI-D, AC (Eur & NA)	VGA, DVI-D, AC (Eur & NA)

Mechanical and Environmental

Parameter	Specification
Operating Temperature	-10 to 50°C
Operating Humidity	20 to 80% RH, non-condensing
Storage Temperature	-20 to 60°C
Storage Humidity	10 to 80% RH, non-condensing
Active Area Surface Treatment	Anti-glare, 3H hard coating
Weight <small>(w/touchscreen)</small>	LC17: 10.0 lbs. (4.5 kg) LC19: 11.3 lbs. (5.12 kg)
Random sweep vibration, non-operating	5-259 Hz, 1.0 G RMS, 3 axis total

Audio

The LC17 and LC19 are both equipped with a 1W per channel audio circuit. Input and output jacks are provided. No speakers are present.

Video Compatible Modes

Analog Signal List

Item	Comment	Resolution	Vertical Refresh Rates
1	IBM & VESA VGA	640 x 350	70 Hz
2	IBM VESA VGA	640 x 400	70 Hz
3	IBM VESA VGA	720 x 400	70 Hz
4	IBM VESA VGA	640 x 480	60 Hz, 72 Hz, 75 Hz
5	VESA SVGA	800 x 600	56 / 60 / 72 / 75 Hz
6	VESA XGA	1024 x 768	60 / 70 / 75 Hz
7	VESA SXGA	1280 x 1024	60 / 75 Hz
8	Apple Mac LC	640 x 480	67 Hz
9	Apple Mac II	640 x 480	67 Hz
10	Apple Mac	832 x 642	75 Hz
11	Apple Mac	1024 x 768	75 Hz

Digital Signal List

Item	Comment	Resolution	Vertical Refresh Rates
1	IBM & VESA VGA	640 x 350	70 Hz
2	IBM VESA VGA	640 x 400	70 Hz
3	IBM VESA VGA	720 x 400	70 Hz
4	IBM VESA VGA	640 x 480	60 Hz, 72 Hz, 75 Hz
5	VESA SVGA	800 x 600	56 / 60 / 72 / 75 Hz
6	VESA XGA	1024 x 768	60 Hz
7	VESA SXGA	1280 x 1024	60 / 75 Hz
8	Apple Mac LC	640 x 480	67 Hz
9	Apple Mac II	640 x 480	67 Hz
10	Apple Mac	832 x 642	75 Hz
11	Apple Mac	1024 x 768	75 Hz

Analog Video List

Item	Comment	Resolution	Vertical Refresh Rates
1	NTSC	525 horizontal lines	60 Hz
2	PAL B,G,I	625 horizontal lines	50 Hz

Reliability and Life

Parameter	Specification
Mean Time Between Failures	50k hours at 25°C, 90% confidence level
Time to 50% brightness decay from initial brightness	50k hours minimum at 25°C, operating continuously at maximum brightness

Safety and Regulatory Certifications

- A. FCC Certification
FCC Part 15, Subpart B, Class B - Conducted and Radiated Tests
- B. CE Certification
- C. RoHS Directive 2002/95/EC, 2005/618/EC Ammendment

Emission

EN 55022:1998+A1:2000+A2:2003; Class B	Conducted & Radiated Test
EN61000-3-2:2000, Class D	Harmonic Current Emissions
EN61000-3-3:1995+A1:2001	Voltage Fluctuations and Flicker

Immunity (EN 55024:1998+A1:2001)

IEC 61000-4-2: 2001	Electrostatic discharge immunity test
IEC 61000-4-3: 2002	Radiated, radio-frequency, electromagnetic field immunity test
IEC 61000-4-4: 1995+A1:200+A2:2001	Electrical fast transient/ burst immunity test
IEC 61000-4-5: 2001	Surge immunity test
IEC 61000-4-6: 2001	Immunity to conducted disturbances, induced by radio-frequency fields
IEC 61000-4-8: 2001	Power frequency magnetic field immunity test
IEC 61000-4-11: 2001	Voltage dips, short interruptions and voltage variations immunity tests
C. UL/CUL Certification	Per IEC 606950

TUV Certification

Available Options and Replacement Components

12V Power Supply	902-0156-XX
European AC cord	903-0467-XX
NA AC cord	903-0466-XX
Remote Dimming Cable	903-0612-XX
VGA Cable	903-0468-XX
DVI-D Cable	903-0602-XX

Cooling Kit

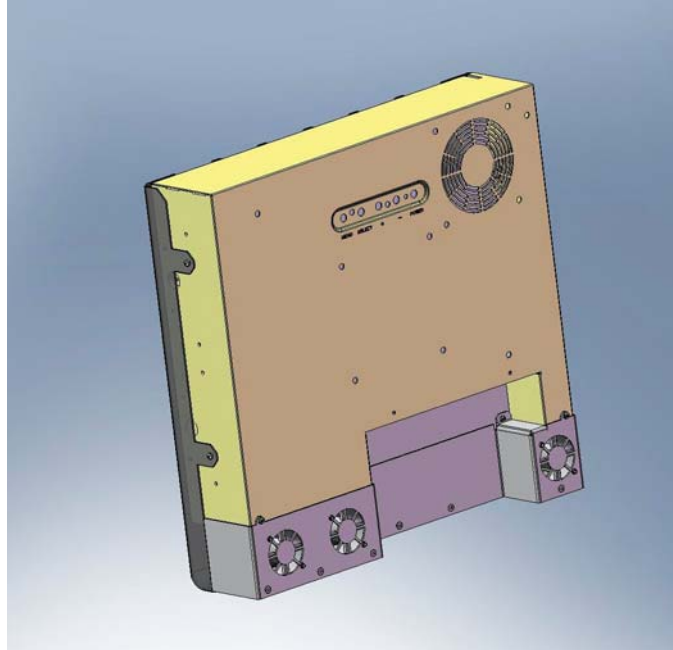

LC17 with cooling kit

For outdoor applications, a cooling kit may be desired to prevent excessive heating of the LCD display.

In direct sunlight, the front surface of the display (the LCD cell) may reach temperatures well above the ambient temperature. Possible effects of extreme surface temperatures include:

- LCD polarizer damage (permanent degraded image)
- LCD fluid clearing (display unreadable)
- Latent image (image burn-in visible)
- Flicker (image jitter)
- Localized non-uniformity (permanent spotty appearance).

The cooling kit consists of a rear-mounted housing containing three fans and a front-mounted baffle that channels the air flow across the display surface. The fans' speed is governed by a temperature sensor adjacent to the photo sensor that is mounted on the front of the monitor. At temperatures above 15°C the fans will turn on at low speed and reach maximum speed at 25°C, thus minimizing the effects of sun loading and high temperatures.

Call factory for information.

IR Touchscreen

LC17 and LC19 with touchscreen

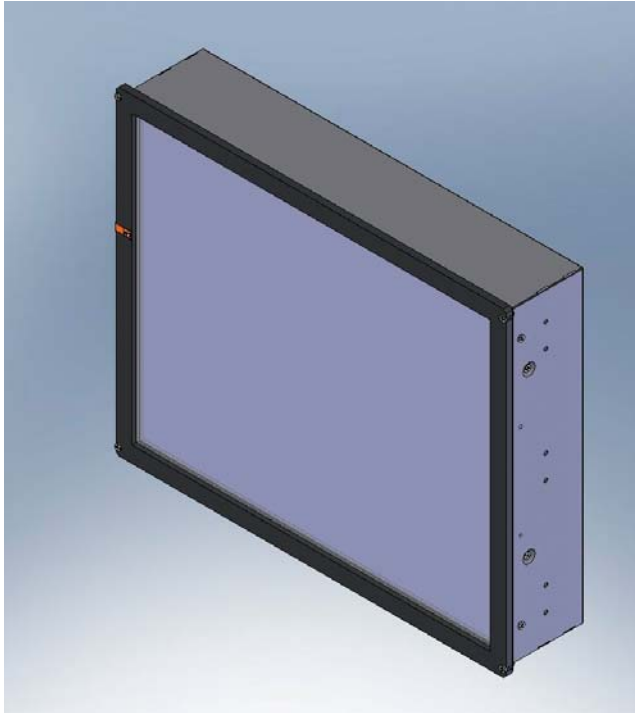

The LC17 and LC19 series monitors are available with IR touch. IR is designed to be installed in nearly any application requiring durability and high light transmissivity. Gloved hand use is OK.

Set Up

1. Refer to Planar mechanical outline drawing for the mounting hole locations.
2. Connect the USB cable from display to USB port on computer.
3. Power on computer and install the IR touchscreen driver found on the provided CD. Follow instructions to calibrate the touchscreen.

Technical Data

- Surface: Glass
- Optical Clarity: 92%
- Surface Scratch Hardness: Mohs Hardness Rating of 5.5
- Touch Contact Requirements: Interrupt IR beams
- Interface: USB

For more information on IR touch products, visit www.irtouch.com

Projected Capacitive Touchscreen

LC 1913RTZ-C with touchscreen and side mounted cooling kit

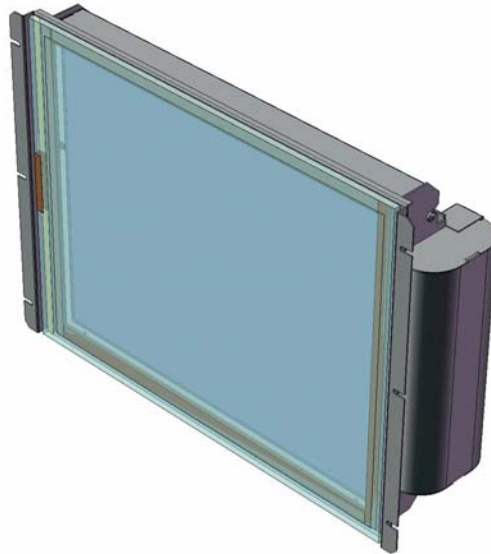

The LC17 and LC19 monitors are available with projected capacitive touch. Projected capacitive is designed to be installed in outdoor applications where rain, splashing liquids, dust, and vandalism are environmental challenges. The sensors are located behind the protective glass layer, whereas traditional capacitive technology employs ITO on the touched surface. Gloved hand use is OK.

Set Up

1. Refer to Planar mechanical outline drawing for the mounting hole locations (Drawing #076-0655-00)
2. Connect the USB cable from display to USB port on computer
3. Power on computer and install touchscreen driver
(found on http://www.planar.com/support/Support_By_Product.htm)

Technical Data

- Surface: Glass
- Optical Clarity: as high as 91%
- Surface Scratch Hardness: Mohs Hardness Rating of 5.5
- Interface: USB

For more information on projected capacitive touch products, visit http://www.zytronic.co.uk/touchscreens_zytouch.htm

Appendix

Troubleshooting

If you are experiencing trouble with the LCD display, refer to the following. If the problem persists, please contact your local stat or visit Planar Support at www.Planar.com/support. See support contact information on rear cover. For all video image problems, first try using the Auto-Adjustment in the OSD menu.

Problem: No image appears on screen.

- Check that all the I/O and power connectors are installed correctly and well connected as described in the " Installation " section.
- Make sure the pins of the connectors are not bent or broken.

Problem: Partial image or incorrectly displayed image.

- Check to see if the resolution of your computer is higher than that of the LCD display.
- Reconfigure the resolution of your computer to make it less than or equal to 1024 x 768

Problem: Image has flickering vertical line bars.

- Use " Frequency " to make an adjustment.
- Check and reconfigure the display mode of the vertical refresh rate of your graphic card to make it compatible with the LCD display.

Problem: Image is unstable and flickering

- Use " Tracking " to make an adjustment.

Problem: Image is scrolling

- Check and make sure the VGA signal cable (or adapter) is well connected.
- Check and reconfigure the display mode of the vertical refresh rate of your graphic card to make it compatible with the LCD display.

Problem: Vague image (characters and graphics)

- Use " Frequency " to make an adjustment. If this problem persists, use "Tracking" to make an adjustment.

Warning Signal

If you see warning messages on your LCD screen, this means the LCD display cannot receive a clean signal from the computer graphics card. There may be three sources for this problem. Please check the cable connections or contact Planar for more information.

No Signal

This message means the LCD display has been powered on but it cannot receive any signal from the computer graphic card. Check all the power switches, power cables, and VGA signal cable.

Going to Sleep

This message means the LCD display is under the power saving mode. In addition, the LCD display will go to this sleeping mode when experiencing a sudden signal disconnecting problem.

Unsupport Mode

This message means the signal of the computer graphic card is not compatible with the LCD display. When the signal is not included in the compatibility mode we have listed in the Appendices of this manual, the LCD display will appear this message.

Out of Range

This typically means the refresh rate or resolution is set too high. Set the resolution to 1024 x 768 and set the refresh rate to 75 Hz or lower. On a PC, these adjustments are typically made using "Display Properties" in the Control Panel folder.

Faint Horizontal Dark Lines Across the Screen

This display is directly backlit by cold cathode fluorescent lamps. Slight brightness nonuniformity is normal.

Mechanical Outline

See mechanical outline drawing on www.planar.com/support

Support and Service

Planar is a US company based in Beaverton, Oregon and Espoo, Finland with a worldwide sales distribution network.

Visit Planar at <http://www.planar.com/support> for product registration, operations manuals, line drawings, touch screen drivers, warranty information and access to Planar's Technical Library for online troubleshooting.

To speak with Planar Customer Support please have your model and serial number available and dial one of these numbers:

Americas Support

Tel: 1-866-PLANAR1 (866-752-6271) or +1 503-748-1100

Hours: M-F, 8am - 8pm Eastern Time | M-F, 5am - 5pm Pacific Time

Europe and Asia-Pacific Support

Tel: +358-9-420-01

Hours: M-F, 7:00am - 4pm CET

Toll or long distance charges may apply.

Planar Systems, Inc.
Customer Service
24x7 Online Technical Support: <http://www.planar.com/support>

Americas Support
Tel: 1-866-PLANAR1 (866-752-6271)
Email: IBUSupport@Planar.com
Hours: M-F, 5am-5pm Pacific Time

Europe and Asia-Pacific Support
Tel: +358-9-420-01
Email: IntlTech_Support@Planar.com
Hours: M-F, 7am-4pm CET

© 2008 Planar Systems, Inc. 8/08 Planar is a registered trademark of Planar Systems, Inc.
Other brands and names are the property of their respective owners.
Technical information in this document is subject to change without notice.

Document No. 020-0599-00B