

NOTES:

- 1. SHEET METAL IS YELLOW ZINC PLATED.
- 2. NOTED SURFACE PAINTED FLAT BLACK.
- 3. AIRFLOW DIRECTION.
- 4. CLEARANCE NEEDED FOR AIRFLOW.
- 5. THIS PRODUCT IS DESIGNED TO BE INSTALLED DIRECTLY BEHIND VANDAL GLASS, BUT MONITOR CHASSIS IS NOT DESIGNED TO ABSORB THE SHOCK OF VANDAL IMPACT.

THIS DRAWING CONTAINS INFORMATION PROPRIETARY TO PLANAR SYSTEMS, INC. ANY REPRODUCTION IN PART OR WHOLE WITHOUT THE WRITTEN PERMISSION OF PLANAR SYSTEMS IS PROHIBITED. THIS DRAWING IS SUPPLIED FOR INFORMATION, IDENTIFICATION, ENGINEERING, EVALUATION, AND/OR INSPECTION PURPOSES ONLY AND MAY NOT BE USED AS BASIS FOR THE MANUFACTURING OF PRODUCTS OR THE FURNISHING OF SERVICES TO PLANAR SYSTEMS OR TO ANY THIRD PARTY UNLESS AUTHORIZED IN WRITING BY PLANAR SYSTEMS.

| REVISIONS | | | | | |
|-----------|-----|-------------|------|--------|--------|
| REV | REF | DESCRIPTION | DATE | REV BY | CHK BY |
| | | | | | |

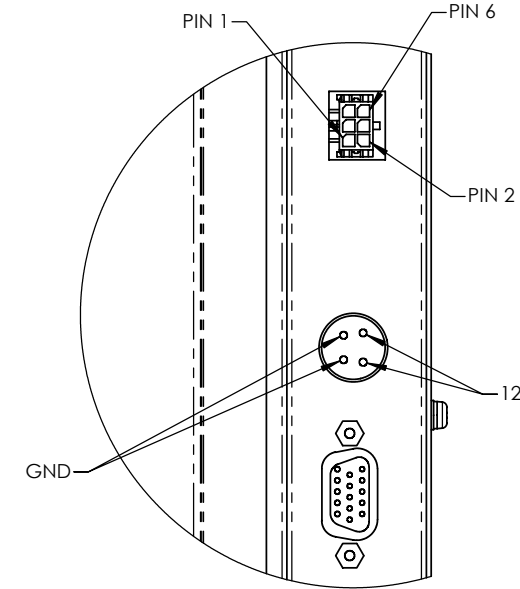
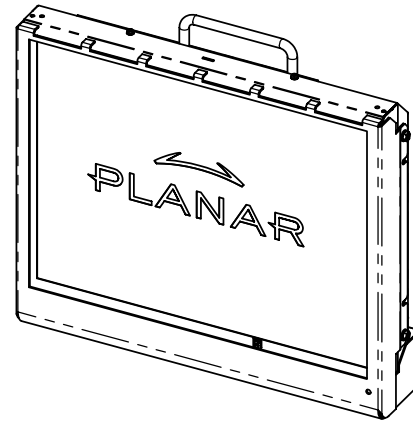

DETAIL A
SCALE 1 : 1

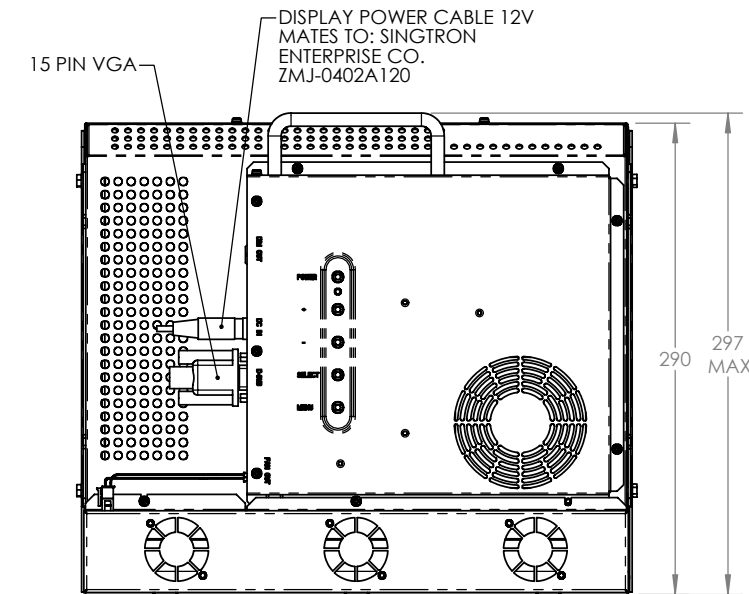
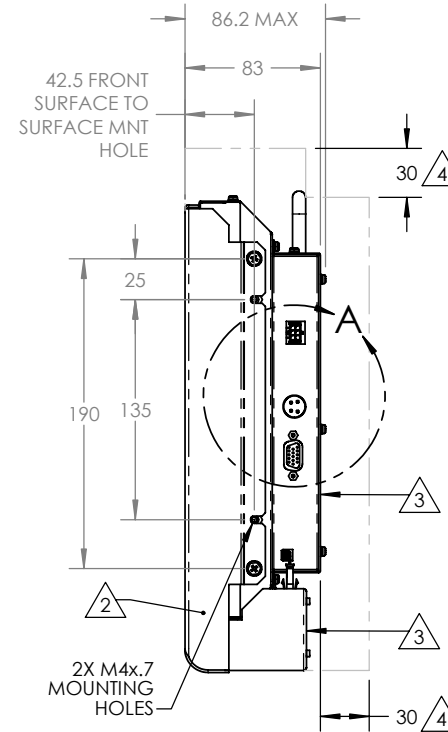
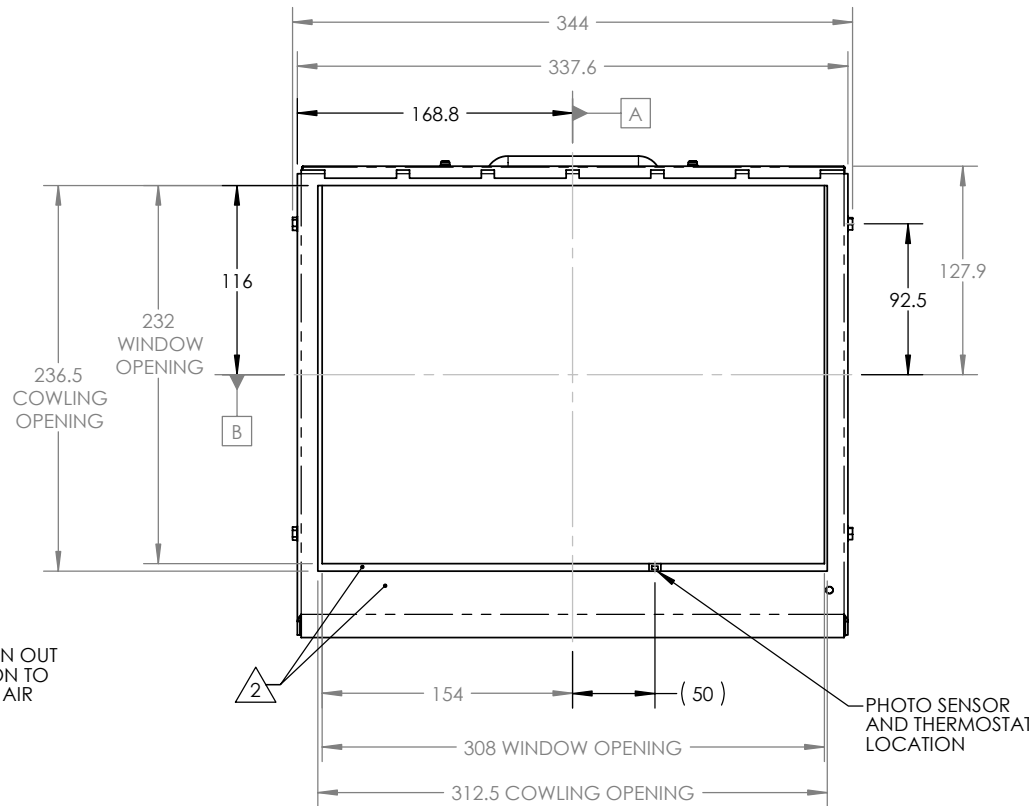
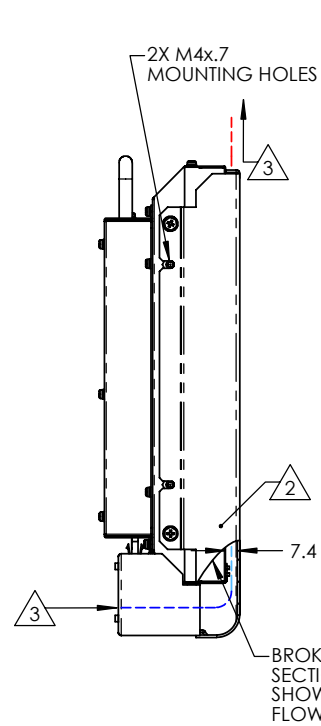
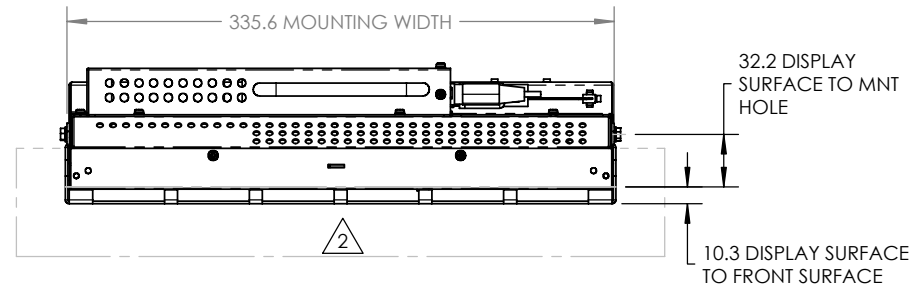

| | | | |
|--|--|--------------------------------|---|
| UNLESS OTHERWISE SPECIFIED DIMENSIONS ARE IN INCHES. | | ENGR BY S.VAHLING 02/10/04 | <p>PLANAR SYSTEMS, INC. 1195 NW COMPTON DRIVE BEAVERTON, OR 97006 USA</p> |
| TOLERANCES: X= ±1 .XX= ±10 .X= ±.5 ANGLES= ±1° | | DRAWN BY R.DAVENTPORT 02/10/04 | |
| DIMENSIONING AND TOLERANCING PER ASME Y14.5M-1994 | | CHECKED BY - | TITLE MECH O/L LC1502R-C COOLKIT |
| THIRD ANGLE PROJECTION | | USED ON 1005101 | SIZE C |
| FINISH SEE NOTES | | MATERIAL NA | PART NUMBER 997-2823-00 |
| | | | DRAWING NO. 076-0582-00 |
| | | | REVISION A |
| | | | SCALE 1:3 DO NOT SCALE SHEET 1 OF 1 |