



PT1500M(U) / PT1501M(U)
Touchscreen LCD Monitors

USER'S GUIDE

www.planar.com

The information contained in this document is subject to change without notice. This document contains proprietary information that is protected by copyright. All rights are reserved. No part of this document may be reproduced, translated to another language or stored in a retrieval system, or transmitted by any means, electronic, mechanical, photocopying, recording, or otherwise, without prior written permission. Windows is a registered trademark of Microsoft, Inc. Other brand or product names are trademarks of their respective holders.

Table of Contents

Usage Notice	
Precautions	1
Introduction	
About the Product	2
Package Overview	5
Installation	
Product Overview	6
User Controls	
Front Panel Controls	14
How to Use the OSD Menus	15
On-Screen Display Menus	16
Appendix	
Troubleshooting	19
Warning Signal	20
Product Dimensions	21
Monitor Specifications	22
Video Modes	23
Touch Screen Driver Installation	24

Usage Notice

 **WARNING** - *To prevent the risk of fire or shock hazards, do not expose this product to rain or moisture.*

 **WARNING** - *Please do not open or disassemble the product as this may cause electric shock.*

Safety and Use Precautions

Follow all warnings, precautions and maintenance as recommended in this User's Guide to maximize the life of your unit.

Do:

- Turn off the product before cleaning.
- Use only a dry soft cloth or clean room wiper when cleaning the LCD panel surface.
- Use only high quality and safety approved AC/DC power adapter.
- Disconnect the power plug from AC outlet if the product is not used for a long period of time.

Don't:

- Do not touch the LCD panel surface with sharp or hard objects.
- Do not use abrasive cleaners, waxes or solvents for cleaning.
- Do not operate the product under the following conditions:
 - Extremely hot, cold or humid environment.
 - Areas susceptible to excessive dust and dirt.
 - Near any appliance generating a strong magnetic field.
 - Place in direct sunlight.

Introduction

About Planar's PT1500M(U), PT1501M(U)

The PT15" products all have a 15" flat panel screen with an active matrix, thin-film transistor (TFT), liquid crystal display (LCD).

Features include:

- Direct analog signal input
- Active matrix TFT LCD technology
- 1024 x 768 XGA resolution
- 15" viewable display area
- 31.5 ~ 60 kHz horizontal scan
- 56 ~ 75 Hz refresh rate
- Auto-adjustment function
- Multilingual OSD user controls
- VESA DPMS power saving
- Kensington security lock slot
- 75 mm VESA mount
- Durable touchscreen

Touch Screen for PT1500M(U)

Resistive for finger and pen interface

- ❑ Surface : Anti-glare treatment
- ❑ Interface : Serial (PT1500M), USB (PT1500MU)
- ❑ Durability : 1,000,000 activations at a single point
- ❑ Hardness of surface : 4H per ASTM D3363-92
- ❑ Operating force : Stylus - <25 g (average)
Finger - <50 g (average)
- ❑ Transmissivity : 85% + / - 2% (typical)
- ❑ Haze : 5%
- ❑ Clarity : 80%
- ❑ Driver : Windows 95/98/Me/NT/2000/XP,
Linux

Touch Screen for PT1501M(U)

Capacitive for finger interface

- ❑ Surface : Anti-glare treatment
- ❑ Interface : Serial (PT1501M), USB (PT1501MU)
- ❑ Durability : 225,000,000 touches in a single location
- ❑ Hardness : Cannot be scratched using any stylus with Mohs' rating of less than 6.5
- ❑ Transmissivity : up to 88% at 550 nm
- ❑ Driver : Windows 95/98/Me/NT/2000/XP,
Linux
MS HID compatible pointing device

Package Overview

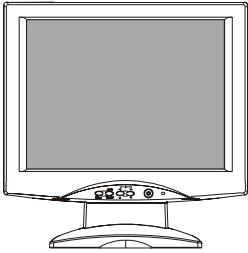

LCD Display

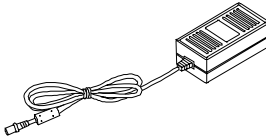

Power Adapter

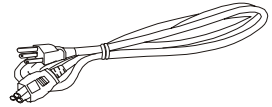

Power Cord

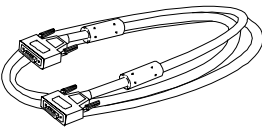

VGA Signal Cable



Audio-In Cable

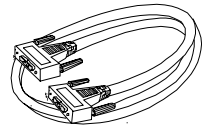

RS-232 Serial Cable
(for PT1500M, PT1501M)



User's Guide



Landing Strip

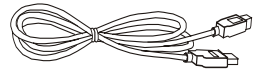

USB Cable
(for PT1500MU, PT1501MU)



Touchscreen Driver
Installation CD-ROM

Installation

Product Overview

◆ Front View

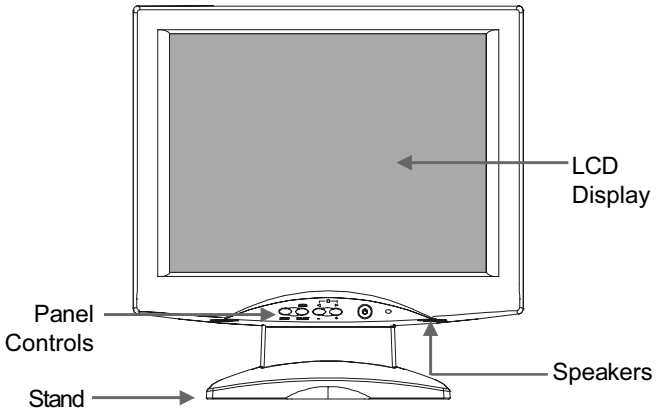

◆ Rear View

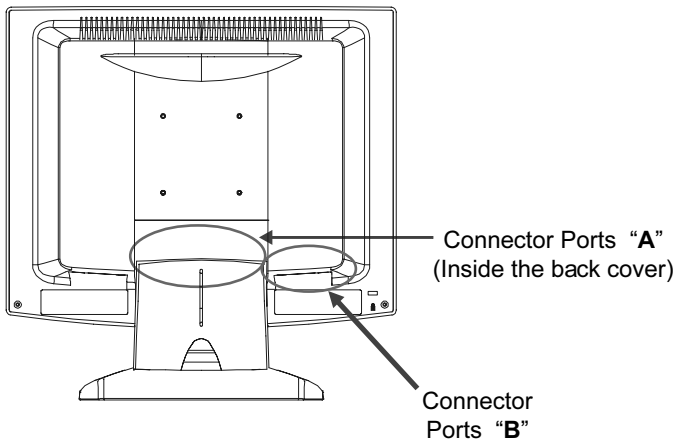

◆ Connector Ports “A”

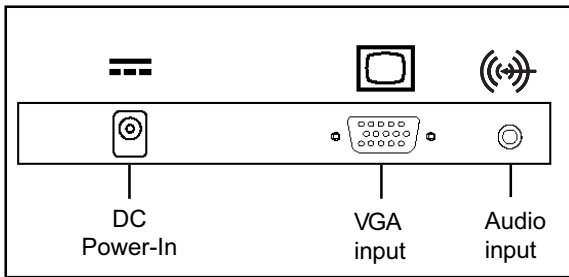

◆ Connector Ports “B”

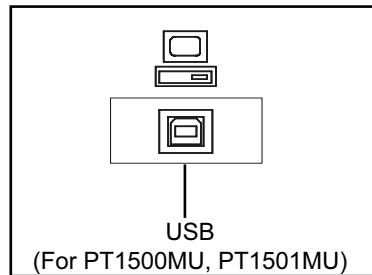
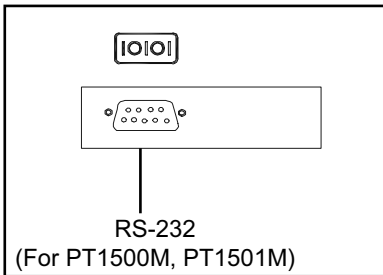

Touch Function

◆ Kensington Security Slot

The monitor can be secured to your desk or any other fixed object with Kensington lock security products. The Kensington lock is not included.

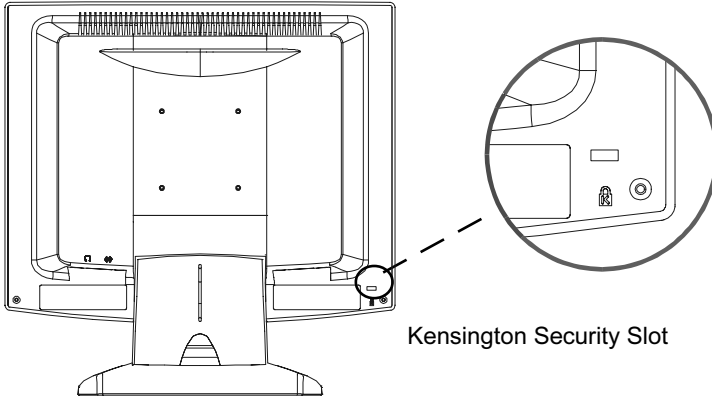

◆ VESA Mount your monitor

This monitor conforms to the VESA Flat Panel Mounting Physical Mounting Interface Standard which defines a physical mounting interface for flat panel monitors, and corresponding standards for flat panel monitor mounting devices, such as wall and table arms. The VESA mounting interface is located on the back of your monitor.

To mount the monitor on a swing arm or other mounting fixture, follow the instruction included with the mounting fixture to be used.

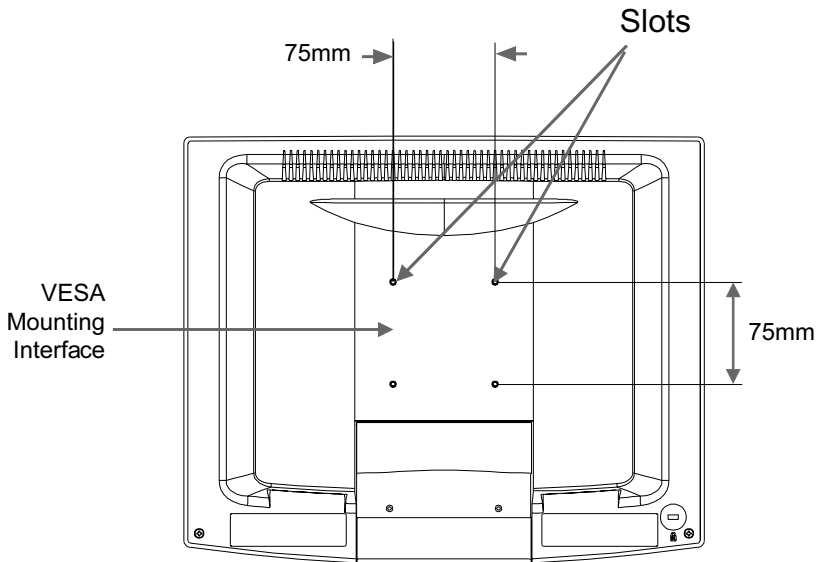

 **Note!**

Please select the proper screws!

The distance between the back cover surface and the bottom of the screw hole is 8mm. Please use a M4 screw.

Start your Installation

◆ Remove the Back Cover

Please follow these instructions to remove the cover on the back panel of the LCD so that you can connect the cables in "Connector Ports B."

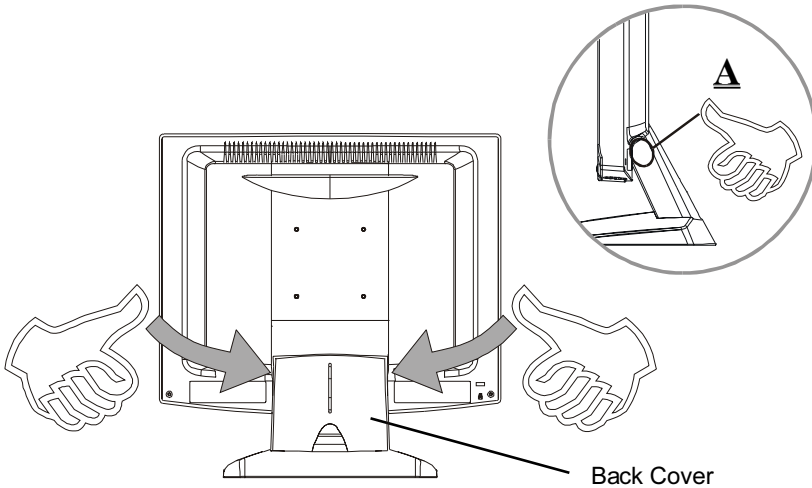

1. To remove the back cover, follow the arrows in Figure A and press with both your thumbs. The cover should be removed by pressing firmly.
2. Follow the instruction on P.12 (Figure 11.1) to connect the cables in "Connector Ports B."
3. Fix the cover back to the LCD. You may also keep the cables in order with the included cable organizer.

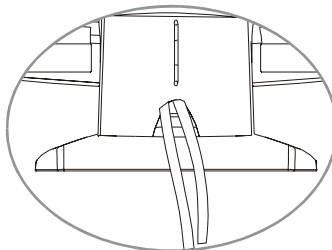

Included Cable Organizer

Note!

You can place the LCD flat horizontally to make it easier to connect the cables. Please make sure that you place it on an even surface lest the LCD should be damaged by scratches or collision.

◆ Connecting the Display (Figure 11.1, 11.2)

Figure 11.2 needs to added for the USB port connection.

To setup this display, please refer to the following figure and procedures.

1. Be sure the computer and monitor are turned off.
2. Connect the DC power cord to the power connector; plug one end of the AC power cord into the power adapter, and then the other end into an electrical outlet (11.1 ❶)
3. Connect the VGA signal cable from the display's VGA input connector to the 15-pin connector of your host computer and tighten the screws (11.1 ❷).
4. Connect the Audio-In cable from the audio input port of your display to the Audio-out port of your computer (11.1 ❸).
5. For the PT1500M and the PT1501M, connect the RS-232 cable from the RS-232 port of your display to the RS-232 port of your computer (11.1 ❹).
6. For the PT1500MU and the PT1501MU, connect the USB cable from the USB port of your display to the USB port of your computer (11.2 ❺).

 ***Notice!***

To ensure the LCD display works well with your computer, please configure the display mode of your graphic card to make it less than or equal to 1024 x 768 resolution and make sure the timing of the display mode is compatible with the LCD display.

We have listed the "Video Modes" of this LCD display in the appendix for your reference.

Figure 11.1

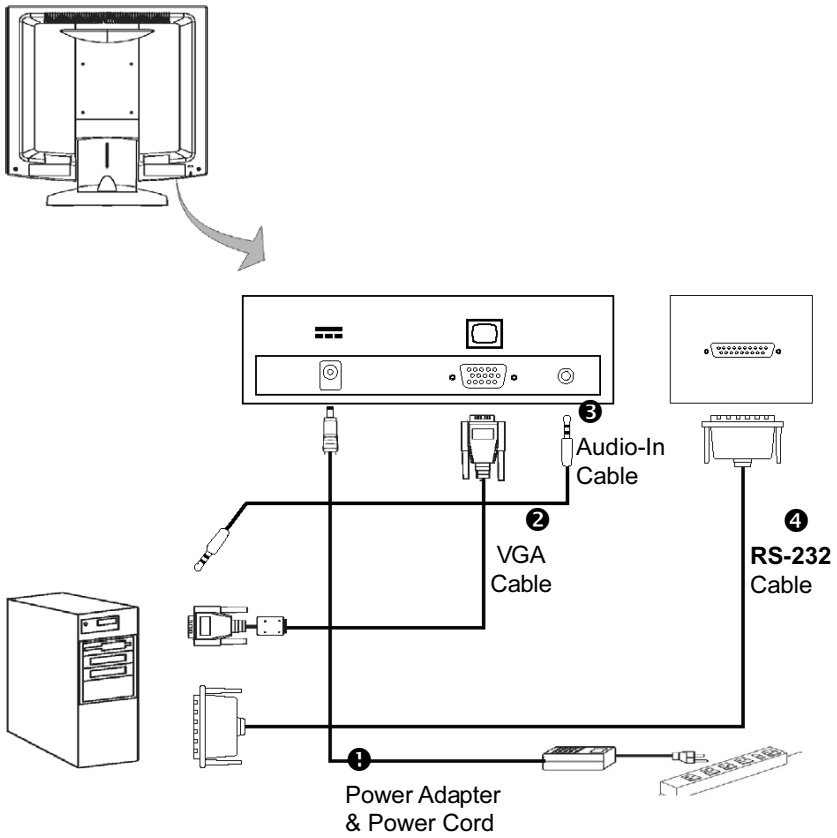
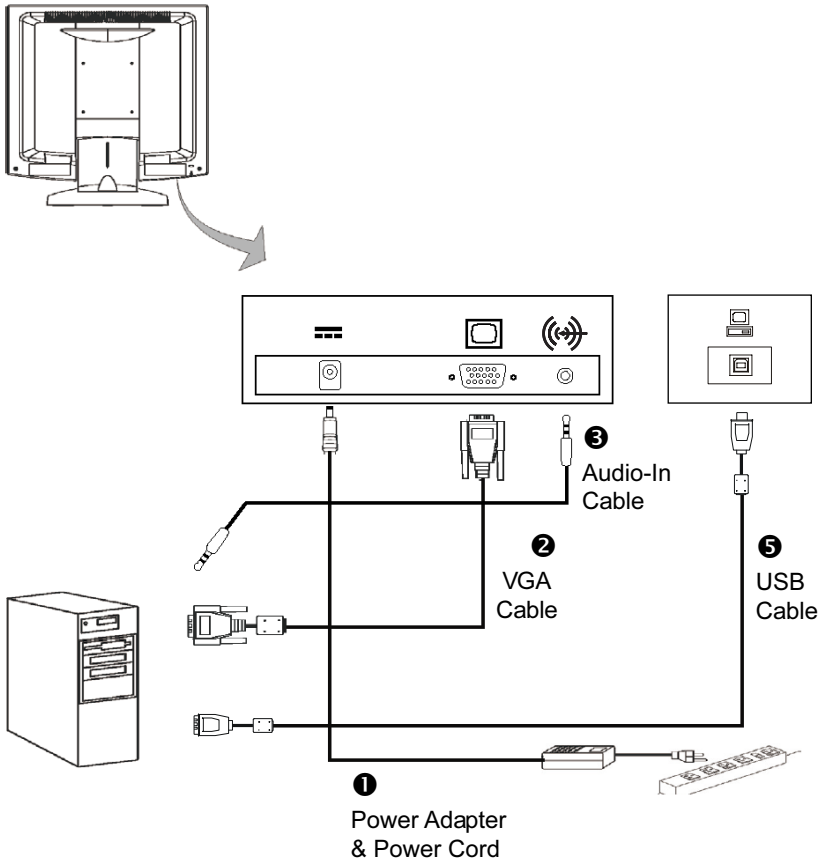
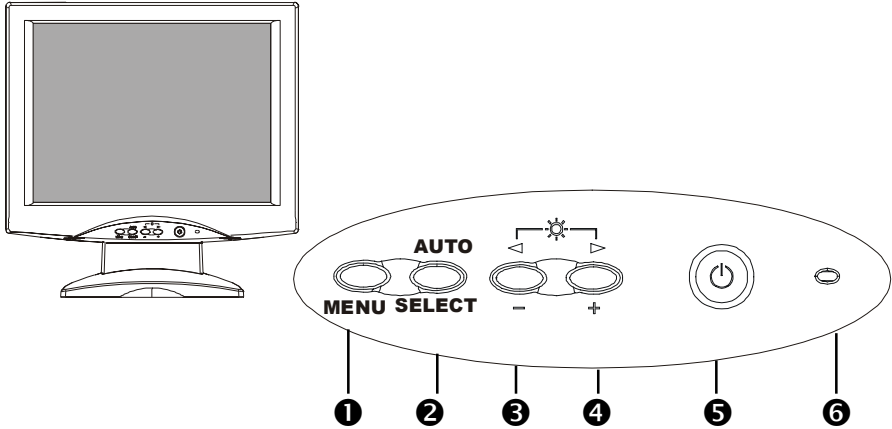



Figure 11.2



User Controls

Front Panel Controls



No./ Icon	Control	Function
❶ MENU	Menu button	Display the OSD menus
❷ SELECT/AUTO	Select/Auto	<i>Select-</i> To select the adjustment items from OSD menus. <i>Auto-</i> To activate the “Auto Adjustment” function to obtain an optimum image.
❸ ◀	Brightness Minus/ Minus	1. Decreases the brightness of the display image. 2. Decreases value of the adjustment items.
❹ ▶	Brightness Plus/ Plus	1. Increases the brightness of the display image. 2. Increases value of the adjustment items.
❺ 	Power Switch	Switches on/off the power of the LCD display.
❻	Power LED	1. Green indicates the display is turned on. 2. Amber indicates the display is in power-saving mode.

How to Use the OSD Menus

1. Press the “Menu” button to pop up the on-screen menu and to select between the four Main Menus.
2. Choose the adjustment items by pressing the “Select/Auto” button.
3. Adjust the value of the adjustment items by pressing the “◀” or “▶” button.
4. The OSD menu will automatically close, if you have left it idle for a pre-set time.

On-Screen Display Menus

Main OSD Menu:

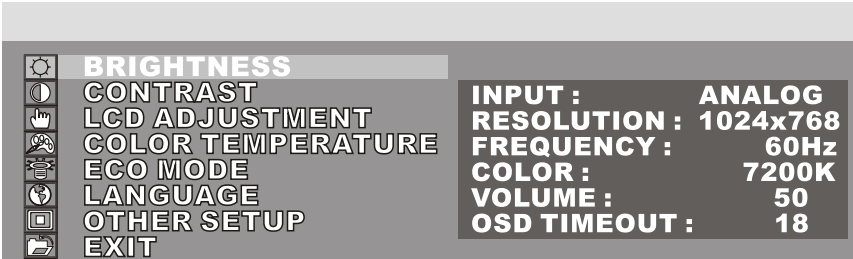

▶ **Brightness**

Choose this function to adjust the brightness of the image.

▶ **Contrast**

Choose this function to adjust the contrast of the image.

▶ **LCD Adjustment**

Opens the LCD Adjustment sub-menu where you can adjust the Clock, Phase, Horizontal Position and Vertical Position parameters.

▶ **Color Temperature**

Opens the Color Temperature sub-menu where you can select the desired Color Temperature of the image.

▶ **ECO Mode**

Enables or disables the power savings mode.

▶ **Language**

Opens the Language sub-menu where you can select the desired language of the OSD.

▶ **Other Setup**

Opens the Other Setup sub-menu where you can adjust the Smooth, OSD Position, OSD Transparency, OSD Time Out, Volume and Mode Message parameters.

LCD Adjustment Sub-Menu:

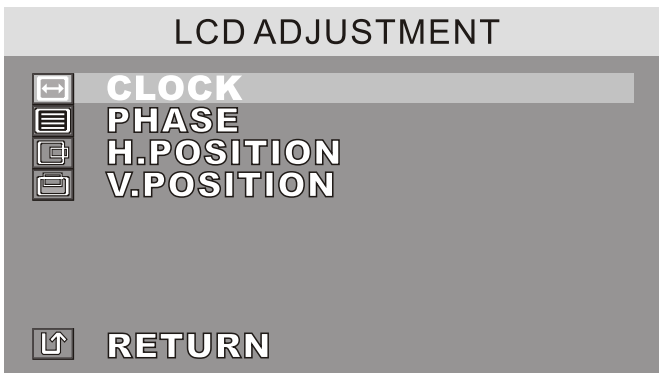

- ▶ **Clock**
Minimizes any vertical bars or stripes visible on the screen.
- ▶ **Phase**
Minimizes any horizontal distortion and clears or sharpens the displayed characters.
- ▶ **H. Position**
Changes the horizontal position of the image.
- ▶ **V. Position**
Changes the vertical position of the image.

Other Setup Sub-Menu:

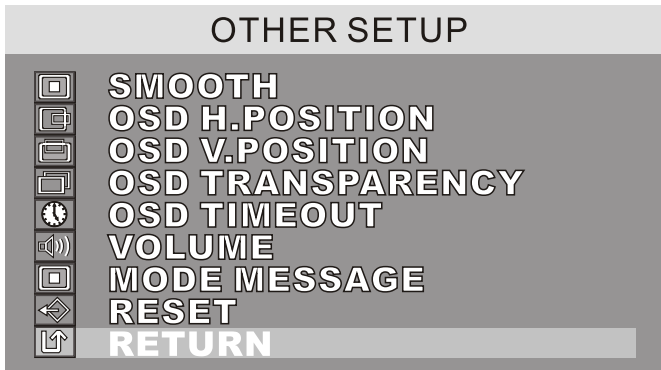

▶ **Smooth**

Adjusts the smoothness of the image.

▶ **OSD H. Position**

Changes the horizontal position of the OSD.

▶ **OSD V. Position**

Changes the vertical position of the OSD.

▶ **OSD Transparency**

Changes the opaqueness of the OSD background.

▶ **OSD Time out**

Adjusts the amount of time the OSD menu will be displayed for after inactivity.

▶ **Volume**

Adjusts the sound volume.

▶ **Mode Message**

Enables or disables the display of information.

▶ **Reset**

Resets the display parameters back to its factory default settings.

Appendix

Troubleshooting

If you are experiencing trouble with the LCD display, refer to the following. If the problem persists, please contact your local dealer or our service center.

Problem: No image appears on screen.

- ▶ Check that all the I/O and power connectors are correctly and well connected as described in the “ Installation ” section.
- ▶ Make sure the pins of the connectors are not crooked or broken.

Problem: Partial image or incorrectly displayed the image.

- ▶ Check to see if the resolution of your computer is higher than that of the LCD display.
- ▶ Reconfigure the resolution of your computer to make it less than or equal to 1024 x 768.

Problem: Image has flickering vertical line bars.

- ▶ Use “ Clock ” to make an adjustment.
- ▶ Check and reconfigure the display mode of the vertical refresh rate of your graphic card to make it compatible with the LCD display.

Problem: Image is unstable and flickering

- ▶ Use “ Phase ” to make an adjustment.

Problem: Image is scrolling

- ▶ Check and make sure the VGA signal cable (or adapter) is well connected.
- ▶ Check and reconfigure the display mode of the vertical refresh rate of your graphic card to make it compatible with the LCD display.

Problem: Vague image (characters and graphics)

- ▶ Use “ Clock ” to make an adjustment. If this problem still exists, use “Phase” to make an adjustment.

Warning Signal

If you see warning messages on your LCD screen, this means that the LCD display cannot receive a clean signal from the computer graphics card.

There may be two sources for this problem. Please check the cable connections or contact Planar for more information.

▶ No Signal

This message means that the LCD display has been powered on but it cannot receive any signal from the computer graphic card. Check all the power switches, power cables, and VGA signal cable.

▶ Out of Range

This message means that the signal of the computer graphic card is not compatible with the LCD display. When the signal is not included in the “Video Modes” list we have listed in the Appendices of this manual, the LCD display will display this message.

Product Dimensions

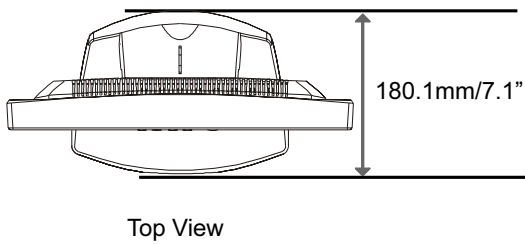
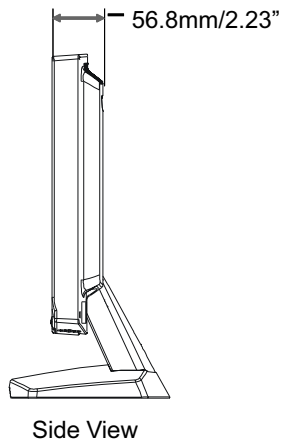
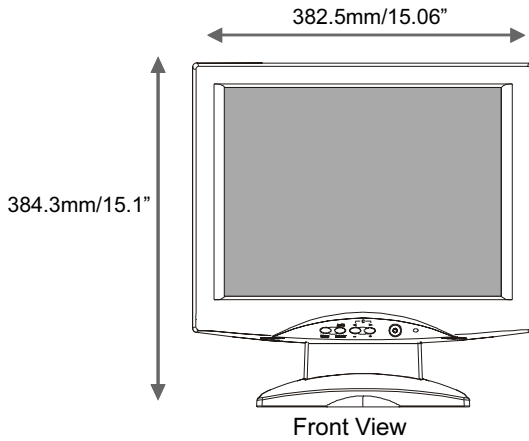

Monitor Specifications

Item	Specification
LCD Module	15-in, active matrix TFT, anti-glare coating, 0.297 mm pixel pitch
Display Size	304 mm x 228 mm
Viewing Angle	
Left/Right	60/60 left/right
Up/Down	40/60 up/down
Display Colors	16,777,216 (8bits/color) with FRC
Power Input	100 ~ 240 VAC Full Range, 50/60 Hz (External AC adapter)
Maximum power consumption	<30W (5W Standby)
Signal Input	
Video Signal	RGB positive 0.7VPP, 75ohm
Sync signals	Separate, TTL Level
Line (horizontal) frequency	31.5 kHz to 60kHz
Raster (vertical) frequency	56 Hz ~ 75 Hz
Pixel dot clock	78.75MHz
Recommended mode	1024 x 768 @ 60 Hz
Pedestal tilt	-5 ~ 25 degress
Dimensions (W x H x D)	382.5 x 384.3 x 180.1 mm
Weight	5.1 kgs
Operating Conditions	
Temperature	5 ⁰ ~ 35 ⁰ C / 41 ⁰ ~ 95 ⁰ F
Humidity	80% maximum
Altitude	3658m
Storage Conditions	
Temperature	-20 ⁰ ~ 60 ⁰ C / -4 ⁰ ~ 140 ⁰ F
Humidity	80% maximum
Altitude	12,193m

Video Modes

The monitor supports the following industry-standard combinations of screen resolution and refresh rates. Other combinations are possible, but may require adjustments to the image.

For the optimal performance, set your computer to a screen resolution of 1024 x 768 at a 60 Hz refresh rate.

Display Mode		Hsync (kHz)	Vsync (Hz)
VGA	640 x 350	31.5	70
	640 x 400	31.5	70
	640 x 480	31.5	60
		37.9	72
		37.5	75
SVGA	800 x 600	35.2	56
		37.9	60
		48.1	72
		46.9	75
XGA	1024 x 768	48.4	60
		56.5	70
		60	75
US TEXT	720 x 400	31.5	70
Apple MAC	640 x 480	34.9	67
		35	67
	832 x 624	49.7	75
	1024 x 768	60.2	75

Touch Screen Driver Installation

Driver Installation for PT1500M: Resistive Touch Screen with RS-232 Serial Connection

*Touch driver information is located on the enclosed CD-ROM for the following operating systems: **Microsoft Windows® XP, Windows 2000, Windows NT 4.0, Windows Me, and Windows 9X.***

1. Open the CD-Rom.
2. Select the link for your monitor model.
3. The driver file will automatically open.
4. Select the "TW564SR4.exe" file.
5. Select "unzip"
6. Double click the "setup.exe" file.
7. Follow the installation instructions.
8. If the touch screen driver does not automatically load, restart the computer operating system.

Please read "Readme.txt" located in the unzipped file folder for additional information and assistance.

Driver Installation for PT1500MU: Resistive Touch Screen with USB Connection

*Please note: These monitors are **Microsoft Windows®** HID (Human Interface Device) compatible. No additional software driver is required for general operation of the touch screen.*

*A special calibration tool can be installed for improved touch position accuracy. See **Optional MicroTouch™** USB HID Calibration Tool version 7.00 **Installation Process***

Optional Driver MicroTouch™ USB HID Calibration Tool Version 7.00 Installation Process for PT1500MU: Resistive Touch Screen with USB Connection

Please note: These monitors are Microsoft HID (Human Interface Device) compatible. The calibration driver is not required for general operation of the touch screen.

This calibration tool is for optimization of touch performance for the touch screen to meet the 1% TPE accuracy specification.

*The following Microsoft Windows® operating systems are supported by this software driver: **Microsoft Windows® 98SE, Me, 2000, and XP.***

1. Open the CD-Rom.
2. Select the PT1500MU Calibration Option link.
3. The driver file will automatically open.
4. Follow the installation instructions for the MicroTouch HID Calibration procedure.

Please read "Readme.txt" located in the unzipped file folder for additional information and assistance.

Driver Installation for PT1501M: Capacitive Touch Screen with RS-232 Serial Connection

*Touch driver information is located on the enclosed CD-ROM for the following operating systems: **Microsoft Windows®XP, Windows 2000, Windows NT 4.0, Windows Me, and Windows 9X.***

1. Open the CD-Rom.
2. Select the link for your monitor model.
3. The driver file will automatically open.
4. Select the "TW564SR4.exe" file.
5. Select "unzip"
6. Double click the "setup.exe" file.

7. Follow the installation instructions.
8. Reconnect the USB cable
9. If the touch screen driver does not automatically load, restart the computer operating system.

Please read "Readme.txt" located in the unzipped file folder for additional information and assistance.

Driver Installation for PT1501MU: Capacitive Touch Screen with USB Connection

*Touch driver information is located on the enclosed CD-ROM for the following operating systems: **Microsoft Windows® XP, Windows 2000, Windows NT 4.0, Windows Me, and Windows 9X.***

If you have a USB cable connection disconnect the cable from the monitor or the PC before installing the driver.

1. Open the CD-Rom.
2. Select the link for your monitor model.
3. The driver will automatically open.
4. Select the "TW564SR4.exe file.
5. Select "unzip"
6. Double click the "setup.exe" file.
7. Follow the installation instructions.
8. Reconnect the USB cable
9. If the touch screen driver does not automatically load, restart the computer operating system.

Please read "Readme.txt" located in the unzipped file folder for additional information and assistance.

Linux Driver Installation for PT1501MU: Capacitive Touch Screen with USB Connection

*Touch driver information is located on the enclosed CD-ROM. Supported platforms include: **Red Hat® Linux 8.0, Red Hat® Linux 9.0, and SuSE® Linux 8.2 and SuSE® Linux 9.0 on Pentium®-compatible CPUs. The following Xfree86 versions are supported: 4.0.3 and 4.1.0.***

1. Open the CD-Rom.
2. Select the "TwLinux5.62.1" folder.
3. Double click the "Readme.txt" file.
4. Follow the driver selection and installation instructions.

Please read "Readme.txt" located in the unzipped file folder for additional information and assistance.

Planar Systems, Inc.

Customer Service

Online Support : <http://planar.custhelp.com>

Email : desktopmonitors@planar.com

Tel : 1-866-PLANAR-1 (1-866-752-6271)

Hours : m-f, 8am-9pm, Eastern Time

©2004 Planar Systems, Inc. Planar is a registered trademark of Planar Systems, Inc.

Other brands and names are the property of their respective owners.

Technical information in this document is subject to change without notice.