



PLANAR LCD MONITOR PL201M MANUAL

www.planar.com

FCC Information

This equipment has been tested and found to comply with the limits for a Class B digital device, pursuant to part 15 of the FCC Rules. These limits are designed to provide reasonable protection against harmful interference in a residential installation. This equipment generates, uses, and can radiate radio frequency energy, and if not installed and used in accordance with the instructions, may cause harmful interference to radio communications. However, there is no guarantee that interference will not occur in a particular installation. If this equipment does cause harmful interference to radio or television reception, which can be determined by turning the equipment off and on, the user is encouraged to try to correct the interference by one or more of the following measures:

- Reorient or relocate the receiving antenna.
- Increase the separation between the equipment and receiver.
- Connect the equipment into an outlet on a circuit different from that to which the receiver is connected.
- Consult the dealer or an experienced radio/TV technician for help.

FCC Warning:

To assure continued FCC compliance, the user must use the provided grounded power supply cord and the provided shielded video interface cable with bonded ferrite cores. Also, any unauthorized changes or modifications to this TFT LCD would void the user's authority to operate this device.

Department of Industry Canada (IC) Compliance Notice

The digital apparatus does not exceed the Class B limits for radio noise emissions from digital apparatus set out in the Radio Interference Regulations of the Canadian Department of Communications.

SAFETY PRECAUTIONS

Caution: Use a power cable that is properly grounded. Always use the AC cords listed below for each area:

USA	UL
Canada	CSA
Germany	VDE
Switzerland	SEV
Britain	BASEC/BS
Japan	Electric Appliance Control Act

Use an AC cord in other areas that meets local safety standards.

Important Safety Instructions

1. Read the Safety Instructions carefully and keep it for later use.
2. Beware of all warning and instruction signs marked on the products.
3. When cleaning, cut off the electrical supply at all times. Never use liquid or aerosol detergent, use a damp rag instead.
4. Always keep the product away from heavy moisture.
5. keep this product stable at any time. Otherwise the product may fall, hazarding the safety and causing serious damage.
6. Do not clog apertures on the product's coating, required for ventilation purpose. Do not install this product in built-in installation without proper ventilation system. Always keep this product away from all kinds of heat sources.
7. The power source used for this product must match one marked on the product's label. Please consult your dealer or local utility if you have any doubt.
8. In order to avoid the electric shock hazard in use, a 3-wire type plug with a grounding pin is provided. Do not use any kind of plug without grounding.
9. Do not lay the power cord on the pathway or rest anything heavy on it.
10. Check the current flow tolerance of an extension cord before use, make sure that the total amount of the product's current flow does not exceed the limit. A current flow of a wall outlet can never exceed up to 15 amperes.
11. Do not insert objects or pour liquid into this product through it's casting apertures. It may touch a high voltage area causing an electric shock or short the circuit.
12. Do not attempt to repair the product your self or remove the casting. It may expose you to electric shock hazard. Contact a dealer near you for the service.
13. Do not unplug the power cord under the following circumstances. A qualified field service electrician is needed.
 - a. When the power cord is damaged or frayed.
 - b. If liquid has been poured into the product.
 - c. If the product has been exposed to rain or heavy moisture.
 - d. If the product can't be adjusted and operate properly by following the operating instructions. Intent to do the more advanced adjustments yourself may cause extensive work for field service electrician.
 - e. If the product has been dropped or the casting is broken.
 - f. If there is a dramatic change of the performance.
14. A proper type of power cords has been selected according to the country of destination and must be used to prevent electric shock.

CONTENTS

Note: To access our Users Guide Homepage (Page 3) at anytime, simply click on the below Homepage icon or use the arrow icon(s) to browse through each page. When in Homepage, clicking on your desired topic will automatically open each page.

FCC Information.....	1
FCC Warning.....	1
Safety Precautions.....	1
Important Safety Instructions.....	2

Getting Started

Package Contents.....	4
Unique Features.....	4
SRS Trademark and Logo.....	5
Precautions.....	5
Cleaning the TFT LCD Monitor.....	5
Quick Installation.....	6

Operation

Front Control Panel.....	7
Hot Key.....	7
Panel Tilt.....	8
OSD Main Menu.....	9
Image Adjust Menu.....	10 - 11
Color Adjust Menu.....	12 - 13
Audio Menu.....	14
Advanced Menu.....	15
Setup Menu.....	16 - 17

Technical Data

Specifications.....	18
Factory Preset Timings.....	19
Power Management.....	19

Getting Started

Congratulations on your purchase of a TFT LCD Color Monitor. This section lists package contents, features, precautions, as well as cleaning and installation instructions.

Important! Please keep the original box and all packing material for future shipping needs.

Package Contents

Your TFT LCD Color Monitor package includes the following:

TFT LCD Color Monitor
Video cable with 15 pin D-Sub connector/ DVI Cable
Power cord
User Guide

Unique Features

- High resolution, high contrast color TFT LCD providing sharp, flicker-free images.
- Power management circuit conforming to VESA® DPMS™ standard that reduces the energy consumption when the LCD monitor is not in use.
- Equipped with DDC2B™ for Plug & Play compatibility.
- Supports a true UXGA resolution of 1600 x 1200 @ 60Hz
- Saves more than 2/3 of space (foot print) & energy (power).
- All plastic parts are recyclable. All materials are strictly selected to ensure ease of maintenance, inspection, and disposal.
- Approved for TCO'99.
- Free run features. It will search the right frequency without interface.
- Composite sync and sync on green compatibility.
- Five languages in OSD (On Screen Display).
- Out of sync and no signal indication.
- Supports true colors.
- Image smoothing.
- Energy Saving Features.
- Dual inputs (Analog and Digital video capabilities).
- Supports 16 sets of factory preset modes and 16 sets of user's automatically saved modes.

Precautions

Sit at least 18"(45 cm) away from the TFT LCD Color Monitor.

Do not press on the LCD panel as it is very fragile.

Do not touch the LCD panel with your bare hands, as the grease from your skin is difficult to remove and may damage the screen.

Do not expose the LCD monitor directly under sunlight or other heat sources. When in use, the LCD screen should be facing away from light sources to reduce glare.

Choose a well-ventilated area to place your LCD monitor to take adequate exhaustion of heat is important. Do not place anything on top of the LCD monitor.

Ensure the area around the LCD monitor clean and moisture-free.

Do not place heavy objects on the power cord, adapter, video or audio cables.

If smoke, abnormal noise, or strange odor occurs, immediately turn the LCD monitor off and call your dealer. It is dangerous to continue using the LCD monitor.

Do not remove the rear cover by yourself, the display unit contains high-voltage parts, it may expose you to the electric shock hazard. Contact your local dealer for the service if it is needed.

Always handle your LCD monitor with care when moving it.

Cleaning the TFT LCD Color Monitor

To clean the LCD panel:

1. Wipe the screen gently with a clean lens brush of camel hair, or a soft, clean, lint-free cloth. It can remove dust and other particles that may not scratch the LCD panel.
2. If it is still not clean, blow and wipe gently with a soft, clean, lint-free cloth on the LCD panel.

Never pour or spray any liquid onto the LCD monitor.

DO NOT APPLY PRESSURE TO THE LCD PANEL.

Quick Installation

1. Make sure the computer and the LCD monitor are both turned off.
2. Attach the power cord to the LCD monitor.
3. When using a power cord, plug the male end in a wall socket.
4. If using a PC power cord, plug the male end in the socket of the computer power supply (if equipped).
5. Plug one end of the video cable in the (Analog or Digital) video signal connector of LCD monitor and the other end in video signal connector of the computer.
6. Turn on the computer.
7. Turn on the LCD monitor.
8. Adjust the user controls to optimize your personal preference (see Operation section, call your local dealer if you have any problems).



OPERATIONS

To turn the **TFT LCD COLOR Monitor** on, push the power button at the front of the LCD monitor to active. When the power light turns green, the LCD is ready to use. To turn the LCD off, push the power switch button to deactivate the monitor.

Front Control Panel

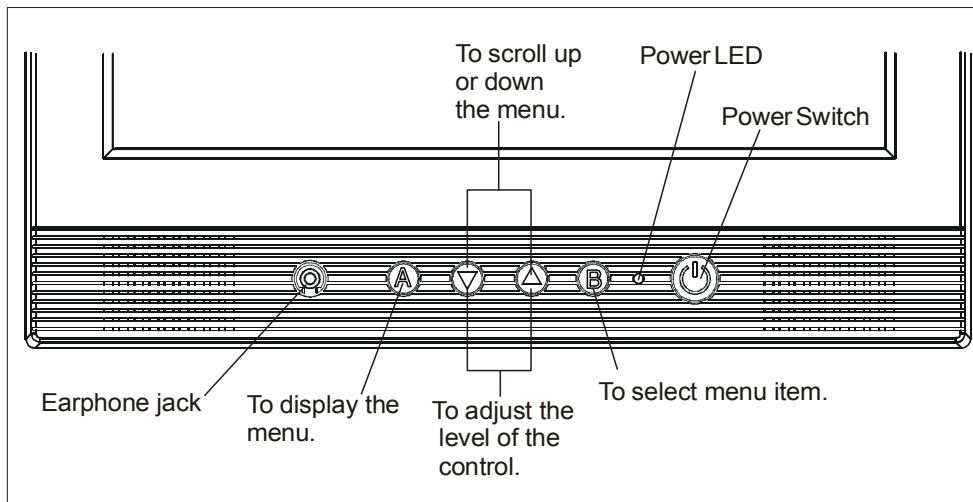

Hot Keys

- **Input Select** Press [**B**] button to activate Input select, then choose your Analog or Digital video input preference.
- **Volume /Contrast / Brightness** Press [∇] or [\triangle] button to activate the volume menu, then use the [**B**] button to select between the Volume /Contrast / Brightness functions. Use the [∇] or [\triangle] buttons to adjust the values of the Volume /Contrast / Brightness function.

Panel Tilt

Diagram 1

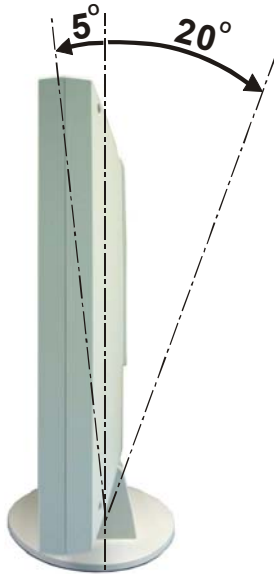

Diagram 2



Diagram 2-1

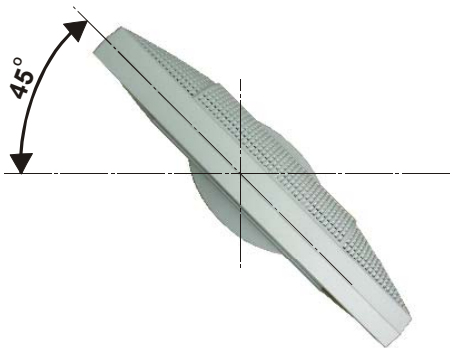

Diagram 2-2

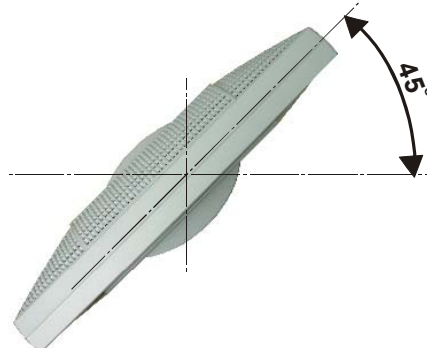

Diagram 1 – Illustrates the display can tilt forward or backwards.

Diagram 2 – Illustrates the display can rotate left or right.

Diagram 2 –1 Swivel angle left

Diagram 2 –2 Swivel angle right

MAIN MENU

The Main Menu is shown below.

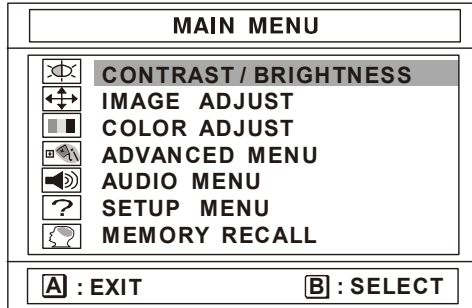

 **CONTRAST** adjusts the difference between the image background (black level) and the foreground (white level).

 **BRIGHTNESS** adjusts the background black level of the screen image.

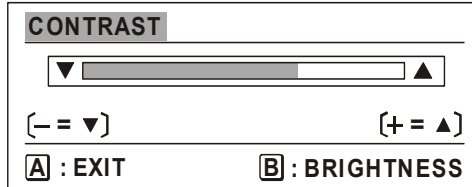



[▽] button decreases the Contrast, [▲] button increases the Contrast.

[▽] button decreases the Brightness, [▲] button increases the Brightness.

Shortcut: Press [▽] or [▲] button at anytime to activate Volume / Contrast / Brightness menu, then use the same buttons to make your adjustments.

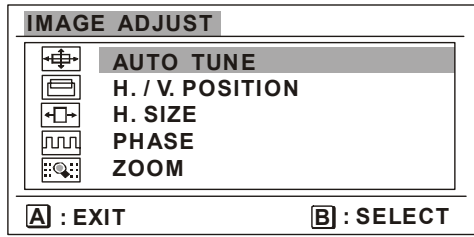
 **IMAGE ADJUST MENU** The Image Adjust Menu is shown below.



 **AUTO – TUNE** automatically sizes, enters, and fine-tunes the video signal to eliminate noise and distortion.

Press [B] button to activate Auto-tune.

 **H POSITION** (Horizontal Position) moves the screen image to the left or to the right.

[▽] button moves the screen image to the left,

[▲] button moves the screen image to the right.

 **V POSITION** (Vertical Position) moves the screen image up or down.

[▽] button moves the screen image down, [▲] button moves the screen image up.

H. / V. Position Diagram

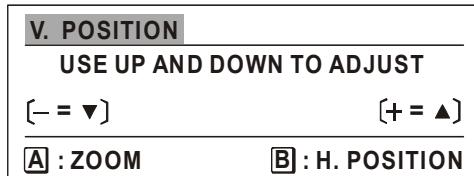
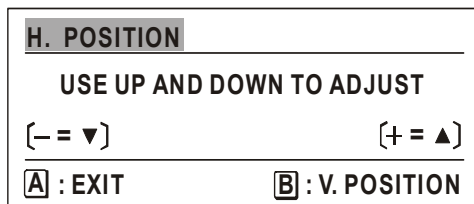



H. SIZE (Horizontal Size) adjusts the width of the screen image.

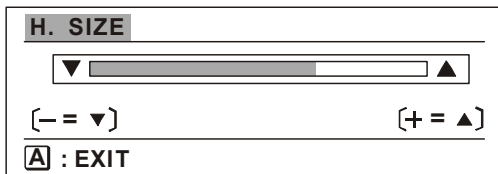

[▼] button decreases the width of the screen image,

[▲] button increases the width of the screen image.



PHASE minimizes the video distortion.

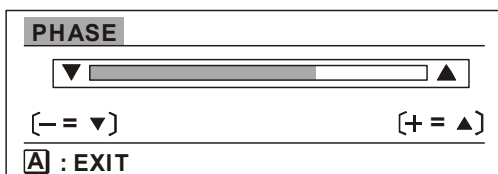

Press the [▼] or [▲] button to adjust your preference.

Please note: When in **Digital Video** mode, **H./V. Position**, **H. Size** and **Phase** will not be applicable as they are automatically optimized.



ZOOM expands and contracts the entire screen image.

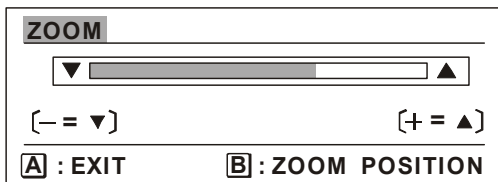



[▼] button expands the screen image, [▲] button contracts the screen image.

To Activate the Zoom H / V Position function, Press the [B] button. Then use the [▼] button to expand or [▲] button to reduce the H / V screen image.

COLOR ADJUST MENU

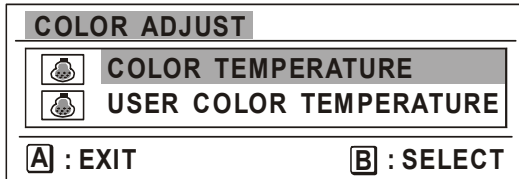
The Color Adjust Menu is shown below:



 **COLOR TEMP SELECT** provides several color options: several preset color temperatures **User Color** which allows you to adjust the Red (R), Green (G), and Blue (B). The factory setting for this product is 9300K (9300 Kelvin).

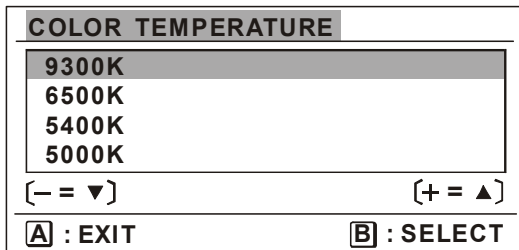

Press [▼] or [▲] button to scroll to your selection.

9300K – Adds blue to the screen image for cooler white (used in most office settings with fluorescent lighting).

6500K – Adds red to the screen image for a warmer white and richer red.

5400K – Adds green to the screen image for a darker color.





5000K – Adds blue and green to the screen image for a darker color.





USER COLOR TEMP. Individual adjustments for red, green, and blue.



Press [] button to increase red, blue or green.

Press [] button to decrease

USER COLOR TEMPERATURE	
R	
B	
G	
Gamma	[Press -/+ to Enter]
[- = ]	[+ = ]
[A] : EXIT	[B] : SELECT

GAMMA Individual adjustments for white, red, blue and green colors.

Press [] or [] to select and make your adjustments.

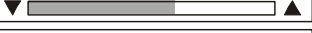
GAMMA	
WHITE	
RED	
BLUE	
GREEN	
[- = ]	[+ = ]
[A] : USER COLOR	[B] : SELECT

AUDIO MENU

The Audio Menu is shown below.

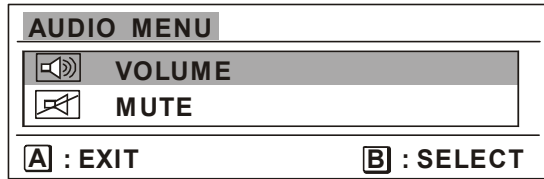

 **VOLUME** adjusts the volume of the audio output.

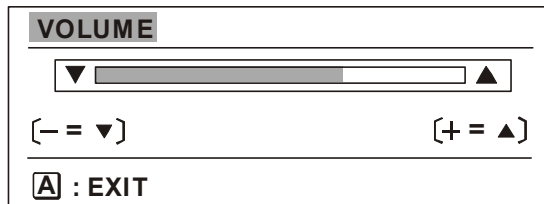

Press [▼] button to decrease the volume, [▲] button to increase the volume.

Shortcut: Press [▼] or [▲] button at anytime to activate and adjust volume level.

 **MUTE** turns Off the volume output.

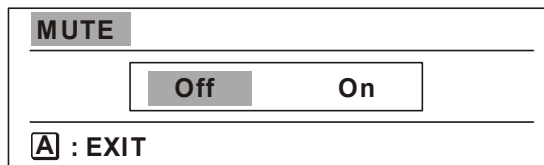

Press [▼] or [▲] button to select **Off** or **On**.



ADVANCED MENU

Selecting the Advanced Menu from the main menu takes you to the submenu shown below.

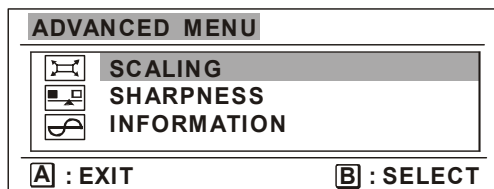

SCALING adjusts the video input signal to the screen size using the following options.

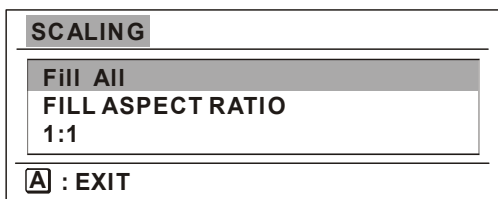

Press [▽] or [△] button to select from the following options:

1:1 adjusts the video signal so that the height and width of the picture are the same.



SHARPNESS adjusts the clarity and focus of the screen image.

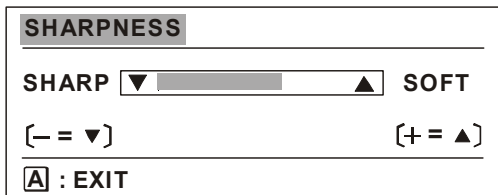

Press [▽] or [△] button to adjust the image sharpness.



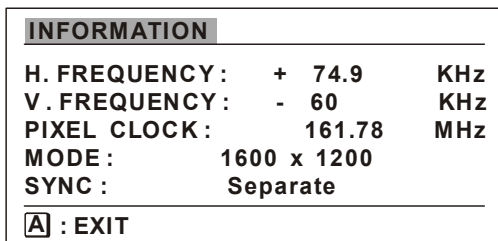

INFORMATION displays the timing mode (Video Signal Input) coming from the graphics card in your computer. See your graphic card's user guide for instructions on changing the refresh rate (vertical frequency).

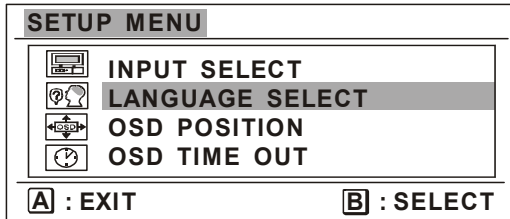

? SETUP MENU

The Setup Menu takes you to the sub-menu shown below.



 **INPUT SELECT** allows you to toggle between two input ports between an analog and digital signal.

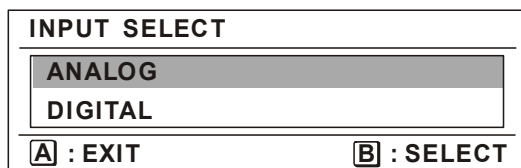

Press [▽] or [△] button to select an input signal.

 **LANGUAGE SELECT** allows you to choose the language used in the menus and control screens.

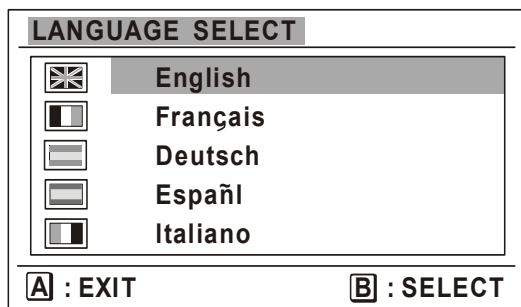

Press [▽] or [△] button to select a language (English, French, German, Spanish or Italian).



OSD POSITION allows you to move the on-screen display menus and control screens.

OSD POSITION	
H. POSITION	▼ [] ▲
V. POSITION	▼ [] ▲
{ - = ▼ }	{ + = ▲ }
[A] : EXIT	[B] : SELECT

Press [*] or [△] button



OSD TIMEOUT sets the length of time the on-screen display screen is displayed. For example, with a “30 second” setting, if a control is not manipulated within 30 seconds, the display screen disappears.

OSD TIME OUT	
▼ [] ▲	
{ - = ▼ }	{ + = ▲ }
[A] : EXIT	



MEMORY RECALL returns adjustments to the original factory settings if the display is operating in a factory Preset Timing Mode in this user guide.

MEMORY RECALL	
PRESS < SELECT > TO ENTER	
{ - = ▼ }	{ + = ▲ }
[A] : EXIT	[B] : SELECT

Note: Using this control resets color to 9300K.

Specifications

LCD	Type	20.1" (full 20.1" viewable diagonal area) TFT (Thin Film Transistor), Active Matrix Panel
	Pixel Pitch	0.255mm pixel pitch
	Color Filter	Pixel RGB vertical stripe
	Color	16.7M (8 bit color)
	Glass surface	Anti-Glare
	Response time	Ton = 15 ms (Typ.), Toff = 10 ms (Typ.)
Maximum Viewing Angles	Horizontal	170° @ CR>10 (Min.)
	Vertical	170° @ CR>10 (Min.)
Input Signal	Video Sync:	RGB Analog (0.7 / 1.0Vp-p, 75 ohms) DVI Digital
	Sync:	H.V. Separate Sync H.V. Composite Sync (TTL Compatible) Sync on Green Fh: 30-82 kHz, Fv: 50-75 Hz
Compatibility	PC	Up to 1600 x 1200
	Macintosh®	Power Macintosh® 1600 x 1200
Resolution		VESA 1600 x 1200 @ 60Hz
Power	Voltage	90 to 264 VAC Universal, 60-50Hz (Auto switch)
Connectors	Input Signal	15 pin D-sub (Analog) & 24 pin DVI (Digital)
Display Area	Full scan	408mm (H) x 306mm (V) 16.06" (H) x 12.05" (V)
Operating Conditions	Temperature	32 F to 104 F (0 °C to 40 °C)
	Humidity	5% to 95% (no condensation)
	Altitude	to 3000 meters or 10,000 feet
Storage Conditions	Temperature	-4 F to +140 F (-20 °C to +60 °C)
	Humidity	5% to 95% (no condensation)
	Altitude	to 12,000 meters or 40,000 feet
Dimensions	Physical	482.0mm(W) x 200.0mm(D) x 458.0mm(H)
	Package	575.0mm(W) x 555.0mm(D) x 260.0mm(H)
Weight	Net	10.0 kg (22.0 lbs)
	Gross	13.0 kg (28.6 lbs)
Tilt		-5° / + 20°
Swivel		R= 45° / L=45°
Regulations	Safety	UL, cUL, TUV/Ergo, TUV/GS, Nordic, CB Report.
	EMI	FCC DoC, CISPR 22 B,
	Low Radiation	MPR 1990:10
	EMC	CE
	Energy Star Program	EPA, NUTEK, SEMKO,
	Quality	SEMKO, Ergonomics, ISO 13406-2
Environment	TCO'99	
Power saving Modes	On	90W (Max.) (green LED)
	Off	3W (orange LED)

- All products and trademarks are brand names of their respective companies.
- Specifications are subject to change without prior notice.

Factory Preset Timing

Timing	Hor. Freq. (KHZ)	Ver. Freq. (HZ)	Polarity (H/V)
VGA 640 X 350	31.47	70.08	+ / -
VGA 720 X 400	31.47	70.08	- / +
VGA 640 X 400	31.47	70.08	- / +
VGA 640 X 480	31.47	59.94	- / -
VESA 640 X 480	37.86	72.81	- / -
VESA 640 X 480	37.50	75.00	- / -
VESA 800 X 600	37.50	75.00	- / -
VESA 640 X 480	35.00	66.67	Composite
VESA 800 X 600	35.16	56.25	+ / +
VESA 800 X 600	37.88	60.32	+ / +
VESA 800 X 600	48.08	72.19	+ / +
VESA 800 X 600	46.88	75.00	+ / +
VESA 832 X 624	49.72	74.54	Composite
VESA 1024 X 768	48.36	60.00	- / -
VESA 1024 X 768	56.48	70.07	- / -
VESA 1024 X 768	58.04	71.92	- / -
VESA 1024 X 768	60.02	75.03	+ / +
VESA 1024 X 768	60.24	74.93	Composite
VESA 1152 X 864	67.50	75.00	+ / +
VESA 1280 X 960	60.00	60.00	+ / +
VESA 1280 X 1024	79.98	75.03	+ / +
VESA 1280 X 1024	63.98	60.02	+ / +
VESA 1600 X 1200	75.00	60.00	+ / +

Power Management System

This monitor matches VESA® DPMS™ (Display Power Management Standard) Standards. For the monitor's power saving features to work, the video board or computer must also match VESA DPMS standards. The Off state means the monitor is in the lowest DPMS state with the highest power savings.

Planar Systems, Inc

Customer Service

E-mail: desktopmonitors@planar.com

Tel: 1-866-PLANAR-1 (1-866-752-6271)

Hours: M-F, 7am - 6pm Pacific Time

© 2002 **Planar Systems, Inc.** 04/02 Planar is a registered trademark of Planar Systems, Inc.
Other brands and names are the property of their respective owners.
Technical information in this document is subject to change without notice.