



LA2250RTPW

Touch Screen LCD Monitor

USER'S GUIDE

www.planar.com

The information contained in this document is subject to change without notice.

This document contains proprietary information that is protected by copyright. All rights are reserved. No part of this document may be reproduced, translated to another language or stored in a retrieval system, or transmitted by any means, electronic, mechanical, photocopying, recording, or otherwise, without prior written permission. Windows is a registered trademark of Microsoft, Inc. Other brand or product names are trademarks of their respective holders.

The test results show that this device meets the FCC rules. Those limits are set to protect residential areas from the devices with harmful emission. This device will produce, use and radiate radio frequency energy. In addition, failure to follow the user's manual to install or use this device might produce harmful interference with radio communication. Notwithstanding the foregoing, it does not guarantee that this type of harmful interference does not occur in some special installations. The interference caused by this device to the reception of radio or television signals may be verified by turning it on and off. Any changes or modifications to this TFT LCD would void the user's authority to operate this device.

For more information on how to recycle your product, please visit WWW.PLANARSYSTEMS.COM/GREEN.

Table of Contents

Usage Notice

Precautions.....	1
------------------	---

Introduction

About LA2250RTPW	2
Touch Screen for LA2250RTPW	2
Package Overview	3

Installation

Product Overview	4
Front View	4
Bottom View	4
Attaching the L-Brackets.....	5
Side Mount for Your Monitor	6
VESA Mount for Your Monitor	8
Connecting the Display (Figure 10.1).....	9
(Figure 10.1).....	10

User Controls

Back Panel Controls	11
How to Use the OSD Menus	12
On-Screen Display Menus	13

Appendix

Troubleshooting.....	14
Warning Signal	15
No Signal	15
Going to Sleep.....	15
Out of Range.....	15
Product Dimensions	16
Compatibility Modes	17
Touch Screen Driver Installation	18
LA2250RTPW Calibration Instruction	19
LA2250RTPW Install Instruction	21
Technical Support.....	22

Usage Notice



Warning - To prevent the risk of fire or shock hazards, do not expose this product to rain or moisture.



Warning - Please do not open or disassemble the product as this may cause electric shock.

Precautions

Follow all warnings, precautions and maintenance as recommended in this user's manual to maximize the life of your unit.

Do:

- Turn off the product before cleaning.
- Touch screen surface may be cleaned using a soft clean cloth moistened with mild window glass commercial cleaners or 50/50 mixture of water and isopropyl alcohol.
- Use a soft cloth moistened with mild detergent to clean the display housing.
- Use only high quality and safety approved AC/DC adapter.
- Disconnect the power plug from AC outlet if the product is not going to be used for an extended period of time.

Don't:

- Do not touch the LCD Display screen surface with sharp or hard objects.
- Do not use abrasive cleaners, waxes or solvents for your cleaning.
- Do not operate the product under the following conditions:
 - Extremely hot, cold or humid environment.
 - Areas susceptible to excessive dust and dirt.
 - Near any appliance generating a strong magnetic field.
 - In direct sunlight.

Introduction

About LA2250RTPW

The LA2250RTPW is a 21.5" flat panel screen with an active matrix, thin-film transistor (TFT) edge-lit LED liquid crystal display (LCD).

This unit is to be used as commercial and light industrial equipment only.

Features include:

- Direct Analog signal input
- Direct Digital signal input
- Edge-lit LED LCD
- 1920 x 1080 resolution
- 21.5" viewable display area - 16:9 aspect ratio
- 31.47 ~ 82.3 KHz horizontal scan
- 56 ~ 75 Hz high refresh rate
- 0.24825mm x 0.24825mm pixel pitch
- Auto adjustment function
- Multilingual OSD user control
- 100 mm VESA mount
- Touch screen with USB controller

Touch Screen for LA2250RTPW

- Projected Capacitive touch screen for finger input only
- Surface: Glare treatment
- Interface: USB controller
- Durability: 250 million touches at a single point
- Hardness of surface: $\geq 7H$
- Transmittance: $90\pm 5\%$
- Driver: Windows® 7, VISTA 64/32 bits, XP, 2000, XP Embedded Express, Linux, Apple® Mac OS

Package Overview

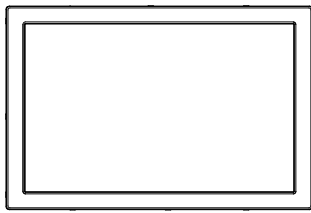

LCD Display

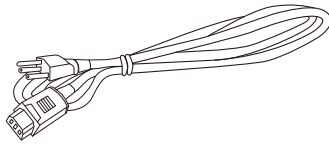

Power Cord

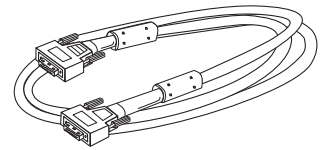

VGA Signal Cable

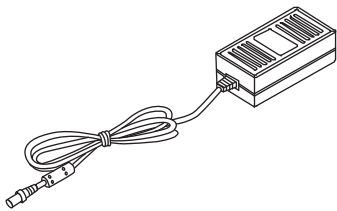

DC Power Supply

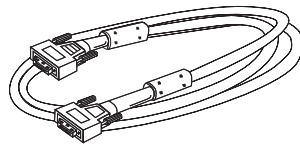

DVI-D Cable

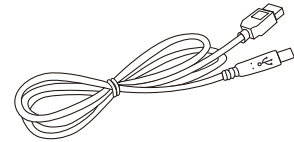

USB Cable (A to B)

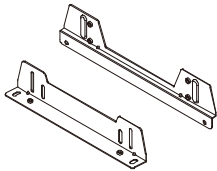

Side Brackets



Landing Strip



Bracket Screws
(Quantity 8)

Installation

Product Overview

- **Front View**

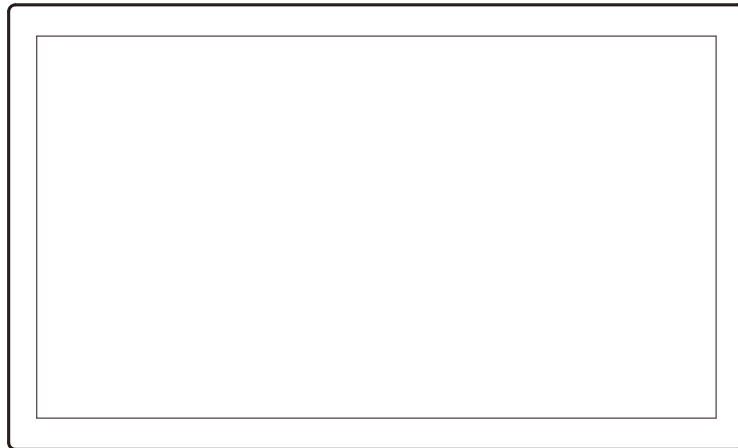

- **Bottom View**

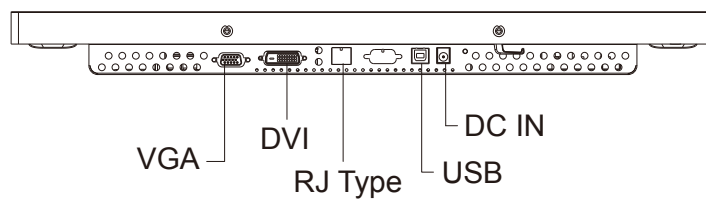

Attaching the Side Brackets

Depending on your mounting scheme, alternately, you may use the side brackets to mount your displays onto your wall or device.

Find a suitable location for attaching side brackets.

- A. The left and right sides
- B. The Top and bottom sides

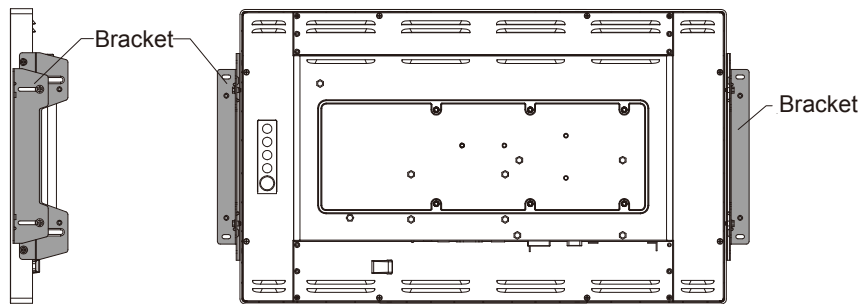

OR

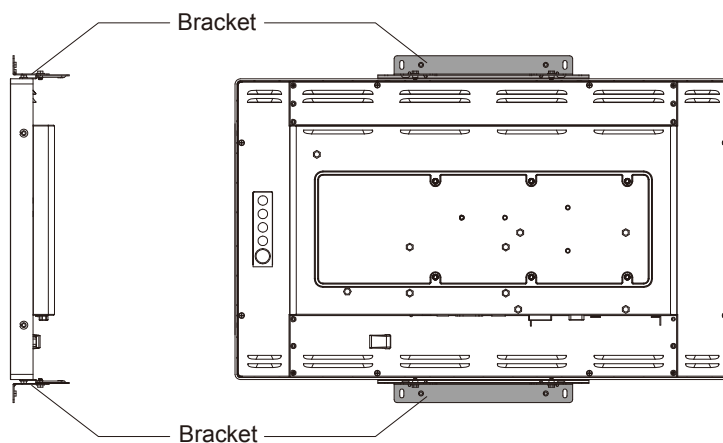

Note:

You will need a screwdriver to attach the side brackets.

Your kiosk touch monitor included four side brackets (and eight screws, M4x6).

This equipment is intended to be mounted in accordance with the proper hardware and the installation instructions supplied with the product. Use of mounting brackets or screws other than those specified in the installation instructions may cause a hazard.

Side Mount For Your Monitor

This monitor can be mounted to the wooden or concrete wall with 8 screws and two pairs of brackets on the opposites. (see page 5)

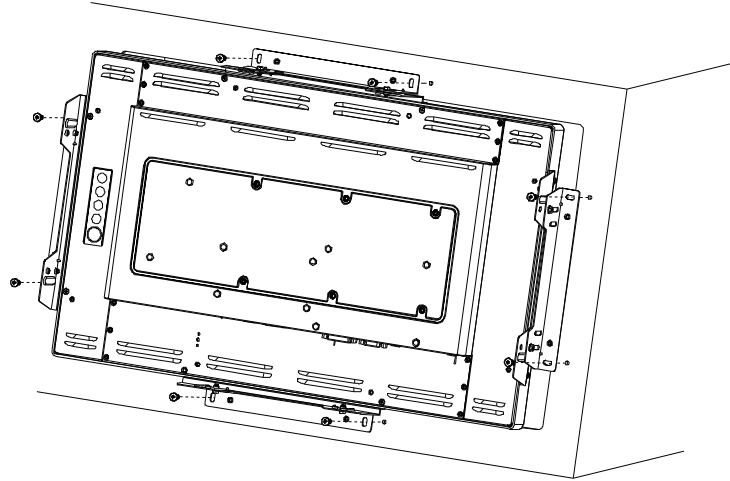

OR

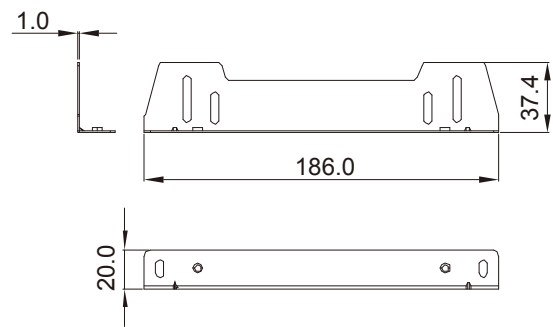
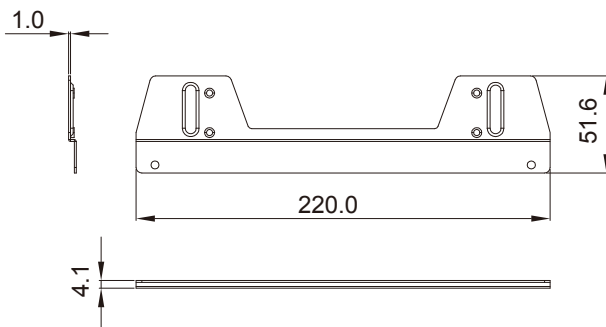
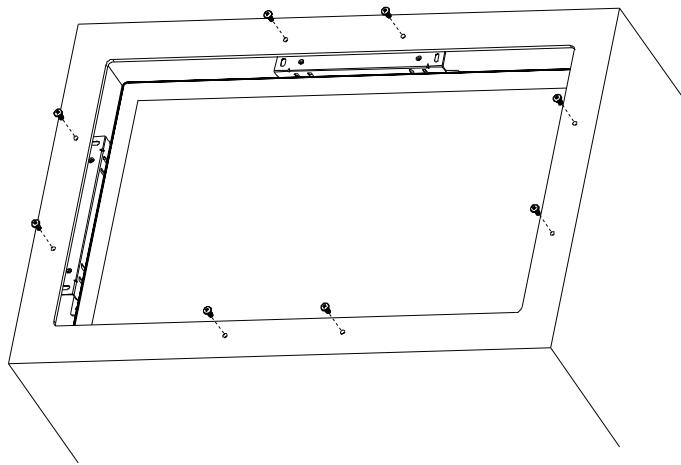

VESA Mount for Your Monitor

This monitor conforms to the VESA Flat Panel Mounting Physical Mounting Interface standard which defines a physical mounting interface for flat panel monitors, and corresponding with the standards of flat panel monitor mounting devices, such as wall and table arms. The VESA mounting interface is located on the back of your monitor.

To mount the monitor on a UL certified swing arm or other mounting fixture, follow the instructions included with the mounting fixture to be used.

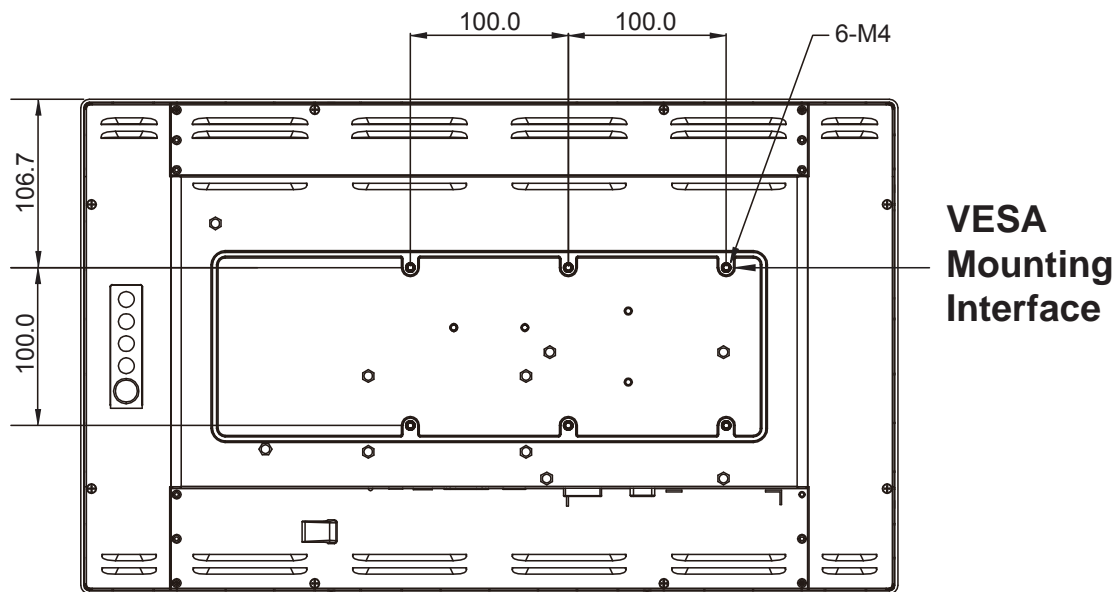

Warning!

Please select the proper screws!

The distance between the back cover surface and the bottom of the screw hole is 8 mm. Please use four M4 screws diameter with proper length to mount your monitor.

Please note: the mounting stand must be able to support at least 17.6 lbs (8Kg).

Connecting the Display (Figure 10.1)

To setup this display, please refer to the following figure and procedures.

1. Be sure all equipment is turned off.
2. Connect the DC plug to the power connector on the monitor and the other end into an electrical outlet (10.1).
3. Connect the D-SUB or DVI cable from the display's D-SUB or DVI input connector to the D-SUB or DVI connector of your host computer and tighten the screws (10.1).
4. Connect the USB cable from the USB port of your display to the USB port (10.1) of your computer.
5. Configure the touch screen. Refer to the "Touch Screen Driver Installation" section on page 18.
6. Once the touch screen is configured, the monitor is ready for use.

Notice!

To ensure the LCD display works well with your computer, please configure the display mode of your graphics card to make it less than or equal to 1920 x 1080 resolution and make sure the timing of the display mode is compatible with the LCD display.

We have listed the compatible "Video Modes" of your LCD display in the appendix (on page 17) for your reference.



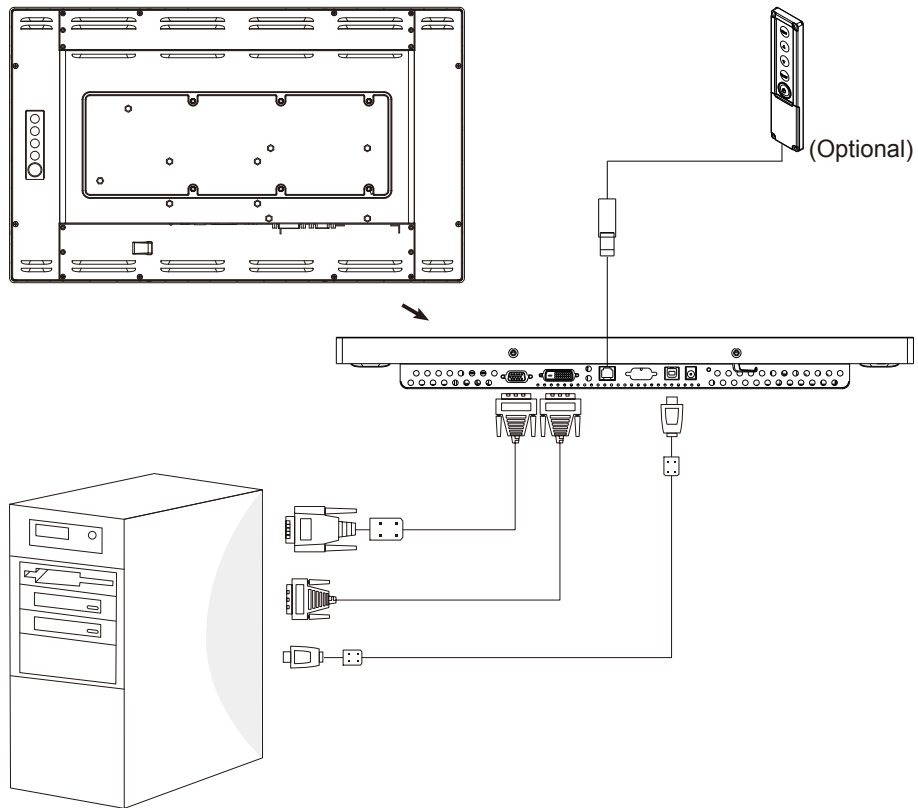

External power supplies applicable: Lite-On/PA-1051-0

(Figure 10.1)



User Controls



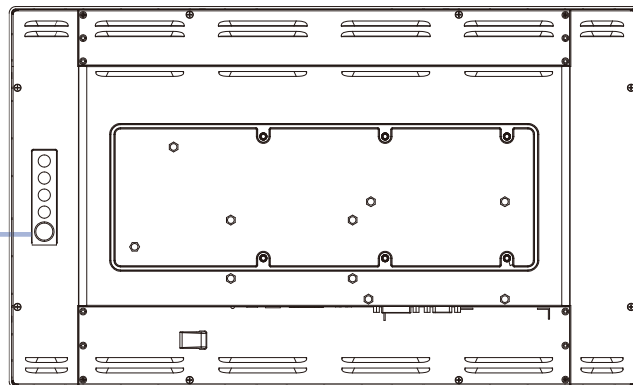

Back Panel Controls

Icon	Key Name
	Menu
	Up
	Down
	Select
	Power



Key	OSD	
	Menu off status	Menu on status
MENU	Menu appear	Menu disappear/return to main item
▲	Brightness	Main item select up/Adjust up
▼	Contrast	Main item select down/Adjust down
SELECT	Enter/Select sub-item function	
	Power On/Off	

How to Use the OSD Menus

Icon	Key Name
	Menu
	Up
	Down
	Select
	Power

1. Press the “MENU” button to pop up the “on-screen menu” and press “Up” or “Down” button to select among the five functions in the main menu.
2. Choose the adjustment items by pressing the “Select” button.
3. Adjust the value of the adjustment items by pressing the “Up” or “Down” button.
4. With the OSD menu on screen, press “ Menu” button to return main menu or exit OSD.
5. The OSD menu will automatically close, if you have left it idle for a pre-set time.
6. To Lock the OSD / Power menu buttons, please follow the instructions below.
(Please note: the monitor has to be turned ON with a valid signal pre-set)
 - (a.) Press “Menu” key , the OSD menu will pops upon display.
 - (b.) Press and hold the “Menu” key again with the OSD menu on the screen, the OSD menu will disappear. Then press the “Power” key 1 time while the menu key is still being pressed. The “Lock/Unlock” menu will appear for 3 seconds.
 - (c.) Use the “Select” key to select OSD or Power setting then set at “Lock” by pushing the “UP” or “Down” button.
 - (d.) When the “UP” or “Down” button is released, the previous setting will be saved and exit the “Lock/Unlock” menu automatically.
7. To Unlock the OSD / Power menu buttons, please follow the instructions below.
(Please note: the monitor has to be turned ON with a valid signal pre-set)
 - (a.) Press and hold the “Menu” key then press the “Power” key simultaneously, the “Lock/Unlock” menu will appear for 3 seconds.
 - (b.) Use the “Select” key to select OSD or Power setting then set at “Unlock” by pushing the “UP” or “Down” button.
 - (c.) When the “UP” or “Down” button is released, the previous setting will be saved and exit the “Lock/Unlock” menu automatically.

Please note:

- a. When the OSD Lock function is selected, this indicates that all the buttons except “power” button are now disabled.
- b. When the Power Lock function is selected, this indicates that the power key is disabled; user can not to turn off the monitor by “Power” key.

On-Screen Display Menus

Main OSD Menu:

ITEM	CONTENT
Contrast	The monitor luminance level control.
Brightness	The monitor backlight level control.
Auto Adjust	Fine-tune the image to full screen automatically.
Left/Right	Moving screen image horizontal position to left or right.
Up/Down	Moving screen image vertical position to up or down.
Horizontal size	The screen image horizontal dot clock adjustment.
Fine	The screen image pixel phase adjustment.
OSD Left/Right	Moving OSD menu horizontal position to left or right.
OSD Up/Down	Moving OSD menu vertical position to up or down.
OSD Time out	OSD auto-disappear time selection.
OSD Language	OSD menu language selection. (English, French, Japanese, Deutsch, Spanish, Italian, Traditional Chinese and Simplified Chinese)
Factory Reset	Factory default value restored.
RGB	Color temperature selection. (9300K, 6500K, 5500K, 7500K, User)

Appendix

Troubleshooting

If you are experiencing trouble with the LCD display, refer to the following. If the problem persists, please contact your local dealer or our service center.

Problem: No image appears on screen.

- ▶ Check that all the I/O and power connectors are correctly and well connected as described in the “Installation” section.
- ▶ Make sure the pins of the connectors are not crooked or broken.

Problem: Partial Image or incorrectly displayed image.

- ▶ Check to see if the resolution of your computer is higher than that of the LCD display.
- ▶ Reconfigure the resolution of your computer to make it less than or equal to 1920 x 1080.

Problem: Image has vertical flickering line bars.

- ▶ Use “Horizontal size” to make an adjustment.
- ▶ Check and reconfigure the display mode of the vertical refresh rate of your graphic card to make it compatible with the LCD display.

Problem: Image is unstable and flickering

- ▶ Use “Fine” to make an adjustment.

Problem: Image is scrolling

- ▶ Check and make sure the VGA signal cable (or adapter) is securely connected.
- ▶ Check and reconfigure the display mode of the vertical refresh rate of your graphics card to make it compatible with the LCD display.

Problem: Vague image (characters and graphics)

- ▶ Use “Horizontal size” to make an adjustment. If this problem still exists, use “Fine” to make an adjustment.

Warning Signal

If you see warning messages on your LCD screen, this means that the LCD display cannot receive a clean signal from the computer graphics card.

Below are the three kinds of warning signals you may receive. Please check the cable connections or contact your sales representative or our service center for more information.

No Signal

This message means that the LCD display has been powered on but it cannot receive any signal from the computer graphics card. Check all the power switches, power cables, and VGA/DVI signal cable.

Going to Sleep

The LCD display will enter power saving mode when experiencing a sudden signal disconnecting problem. The monitor can be activated by pressing any keyboard, triggering the mouse or touching the screen.

Out of Range

This message means that the signal of the computer graphic card is not compatible with the LCD display. When the signal is not included in the “Video Modes” list we have listed in the Appendices of this manual, the LCD monitor will display this message.

Product Dimensions

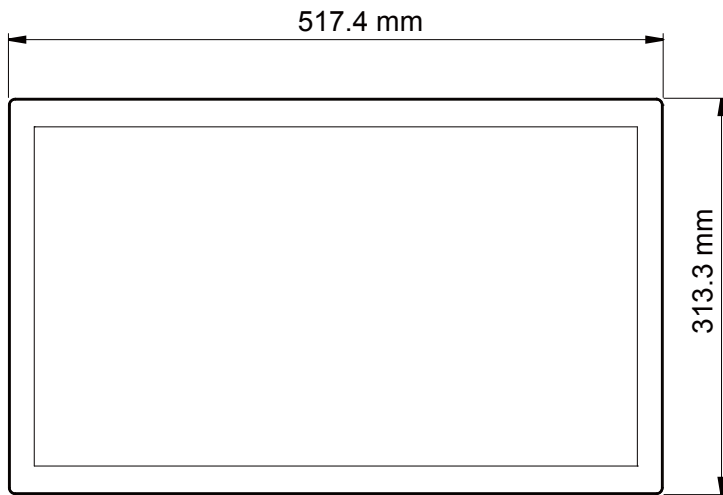

Front View

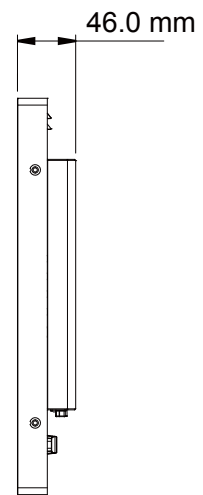

Side View

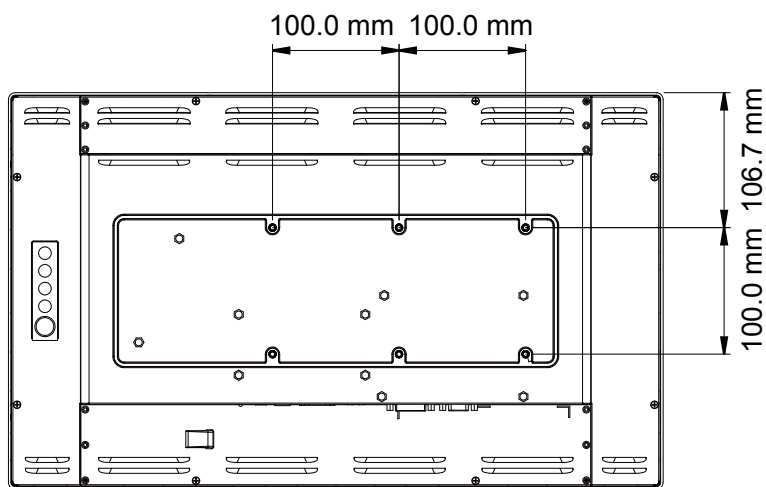

Back View

Compatibility Modes

Mode	Resolution	H-Frequency(khz)	V-Frequency(hz)
IBM VGA	720X400	31.47	70
IBM VGA	640X480	31.47	60
Apple MacII	640X480	35.00	66
VESA VGA	640X480	37.86	72
VESA VGA	640X480	37.50	75
VESA VGA	800X600	35.16	56
VESA VGA	800X600	37.88	60
VESA VGA	800X600	48.08	72
VESA VGA	800X600	46.88	75
Apple Mac	832X624	49.72	75
VESA XGA	1024X768	48.36	60
VESA XGA	1024X768	56.48	70
VESA XGA	1024X768	60.02	75
VESA SXGA	1280X1024	64.00	60
VESA SXGA	1280X1024	80.00	75
VESA SXGA	1152X864	67.50	75
VESA SXGA	1280X960	60.00	60
WXGA+	1440X900	56.00	60
WXGA+	1440X900	70.60	75
WSXGA+	1680X1050	65.20	60
WSXGA+	1680X1050 (VGA only)	82.30	75
VESA WXGA	1280X768	47.776	60
WSXGA+	1920X1080	67.50	60

Touch Screen Driver Installation

The LA2250RTPW is available with USB connection. The touch driver is available online for these operating systems: Windows® 7, VISTA 64/32 bits, XP, 2000, XP Embedded (Express only), Linux, Apple® Mac OS.

Please Note:

1. The LA2250RTPW is Microsoft® Windows® HID (Human Interface Device) compatible if you use the USB touch screen interface. No additional software driver is required for general operation of the touch screen.
2. For LA2250RTPW, the system requires 15 seconds for Windows 7 to install/uninstall the touch driver while turning power on/off or plugging/unplugging USB cable.

LA2250RTPW Calibration Instruction:

Calibrating the touch screen in Windows 7:

1. Tap the Start button, Control Panel and then Hardware and Sound.
2. Under Tablet PC Settings, tap Calibrate the screen for pen or touch input.
3. On the Display tab, under Display options, tap Calibrate and then Yes to allow the program to make changes.
4. Follow the on-screen instructions to calibrate the touch screen.

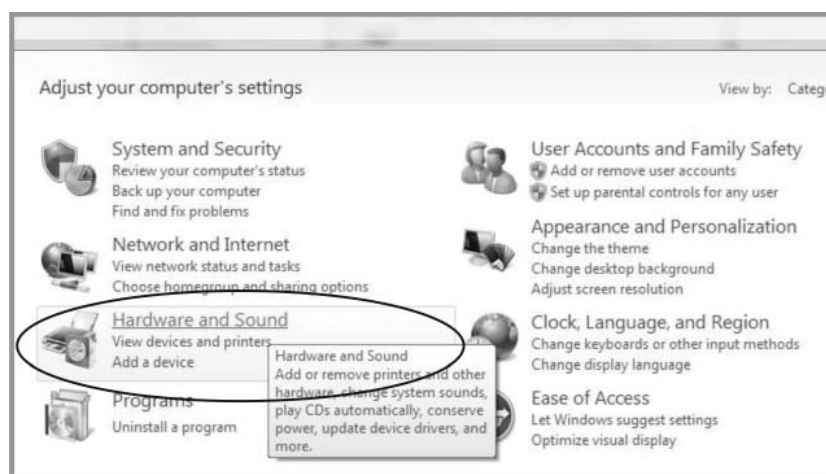
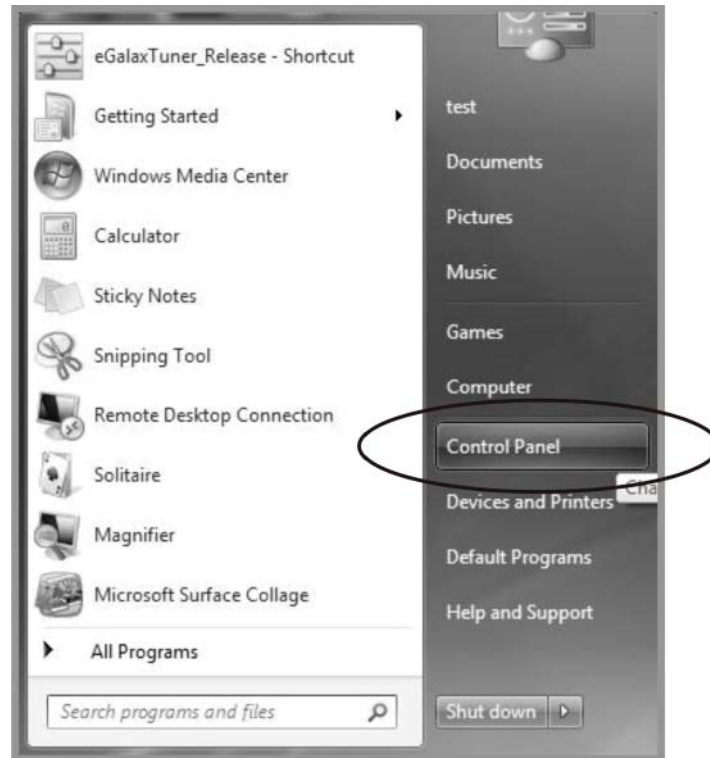

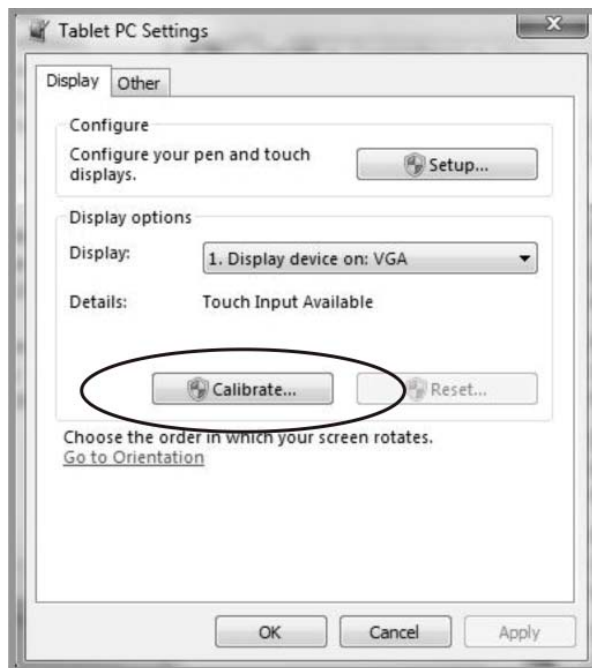
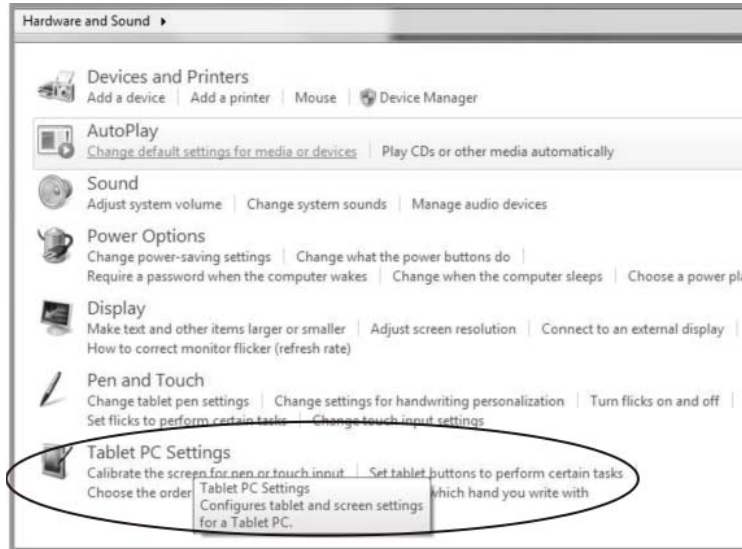

LA2250RTPW Install Instruction:

If you are using a PC running Windows® 7, VISTA, XP, 2000, follow the instructions below:

1. Power on the PC.
2. Be sure the USB cable is connected from the PC to the LCD display.
3. Download the driver online www.planar.com/support and execute.
4. Follow the step-by-step instructions as shown on the pop-up windows.

If you are using a PC running Windows® XP Embedded, follow the instructions below:

Express:

1. Power on the computer.
2. Make sure that the USB cable is connected to the computer.
3. Be sure that your EWF is disabled. If your EWF is enabled, please disable the EWF by using the EWF Manager command.
4. Once the EWF is disabled, download the driver online and execute.
5. Click on the XP driver at www.planar.com/support and follow the step-by-step instructions as shown on the pop-up windows.

If you are using a PC running Linux or Apple® Mac OS, follow the instructions below:

1. Power on the computer.
2. Make sure that the USB cable is connected to the computer.
3. Download the driver online at www.planar.com/support and execute.
4. Follow the step-by-step instructions found in the folder file of the driver.

Technical Support

Cables and Accessories

To find cables and accessories for your Planar monitor, touch screen or other Planar products visit our online store at **www.PlanarOnline.com**.

Technical Support

Visit Planar at **<http://www.planar.com/support>** for operations manuals, touchscreen drivers, warranty information and access to Planar's Technical Library for online trouble shooting.

To speak with Planar Customer Support please have you model and serial number available and dial:

Planar Support

Tel: 1-866-PLANAR1 (866-752-6271) or +1 503-748-5799 outside the US.

Hours: 24 hours a day, 7 days a week.

Toll or long distance charges may apply.

Planar Systems, Inc.

Customer Service

24x7 Online Technical Support: <http://www.planar.com/support>

1195 NW Compton Drive

Beaverton, OR 97006-1992

Tel: 1-866-PLANAR1 (866-752-6271) or +1 503-748-5799 outside the United States.

Hours: 24 hours a day, 7 days a week

© 2013 **Planar Systems, Inc. 3/13** Planar is a registered trademark of Planar Systems, Inc.

Other brands and names are the property of their respective owners.

Technical information in this document is subject to change without notice.

020-1140-01A