



# IX2790 LED LCD Monitor

## USER'S GUIDE

[www.planar.com](http://www.planar.com)

# Content

Operation Instructions.....	1
Safety Precautions.....	3
Consignes de sécurité.....	4
Package Overview.....	5
Front View of the Product.....	6
Rear View of the Product.....	7
Quick Installation.....	8
Basic Operation.....	9
Advanced Operation—OSD Menu.....	11
Supporting Timing Modes.....	18
Technical Information.....	19
Wall-Mount Installation Instructions.....	20
Troubleshooting.....	21
Planar Support.....	22

## Operation Instructions

Thank you for purchasing the IX2790 LED LCD monitor. Please read this guide thoroughly before installation.

### **FCC RADIO FREQUENCY INTERFERENCE STATEMENT WARNING: (FOR FCC CERTIFIED MODELS)**

This LED LCD Monitor has been tested and found compliant with the limits for a Class B digital device, pursuant to part 15 of the FCC Rules. These limits are designed to provide proper protection against harmful interference to a residential installation. This LED LCD Monitor generates, uses, and can radiate radio frequency energy. Harmful interference to radio communication may be the result if it's not properly installed and used. However, there is no guarantee that interference will not occur in a particular installation. If this LED LCD Monitor does cause serious interference to radio or television reception, resetting may correct it. Moreover, users are encouraged to reduce interference by doing one or more of the following:

- Reorient or relocate the receiving antenna.
- Move the LED LCD Monitor and the receiver further away from each other.
- Connect the LED LCD Monitor into an outlet on a circuit different from that to which the receiver is connected.
- Consult your local dealer or a qualified technician.

#### **FCC Warning:**

To assure a continued FCC compliance, a user must use a grounded power supply cord and the provided shielded video interface cable with bonded ferrite cores. Also, any unauthorized changes or modifications to this LED LCD Monitor would void the user's authority to operate this device.

**Note:** If necessary, shielded interface cables and AC power cord must be used to meet the emission level limits.



#### **Important Waste Disposal Information**

Please recycle or dispose of all electronic waste in accordance with local, state, and federal laws. Additional resources can be found online at <http://www.planar.com/about/green/>.

The crossed-out wheeled bin symbol is to notify consumers in areas subject to Waste Electrical and Electronic Equipment (WEEE) Directive 2012/19/EU that the product was placed on the market after August 13, 2005 and must not be disposed of with other waste. Separate collection and recycling of electronic waste at the time of disposal ensures that it is recycled in a manner that minimizes impacts to human health and the environment. For more information about the proper disposal of electronic waste, please contact your local authority, your household waste disposal service, or the seller from whom you purchased the product.

## **COMMUNIQUE D'AVERTISSEMENT DE LA FCC CONCERNANT LES INTERFERENCE DE FREQUENCE RADIO: (SEULEMENT POUR MODELES CERTIFIE PAR LA FCC)**

Ce moniteur a été testé et à été trouvé conforme aux limites pour un appareil numérique de Classe B, suivant la partie 15 des règlements de la FCC. Ces limites ont été développées pour offrir une protection satisfaisante contre les interférences nuisibles dans une installation résidentielle. Ce moniteur génère, utilise et peut radier de l'énergie de fréquence radio. Ceci peut causer des interférences nuisibles à des communication radio si l'appareil n'est pas convenablement installé et utilisé. Il n'y a néanmoins aucune garantie que des interférences n'apparaîtront pas dans une installation particulière. Si ce moniteur cause de sérieuses interférences à la réception de signaux radios ou télévisées, une possibilité est de réinitialiser le moniteur. Les usagers sont aussi encouragés à corriger les interférences en appliquant une ou plusieurs des démarches suivantes:

- Réorientez ou déplacez l'antenne de réception.
- Placez le moniteur et le récepteur plus loin l'un de l'autre.
- Connectez le moniteur à une prise différente de celle à laquelle le récepteur est connecté.
- Consultez votre revendeur local ou un technicien qualifié.

### **Avertissement de la FCC:**

Pour assurez une conformité continue au règlements de la FCC, l'utilisateur doit utiliser un cordon d'alimentation mis à terre et le câble d'interface vidéo protégé avec noyaux en ferrite, fourni avec l'appareil. Chaque modification ou changement non-autorisé appliqué à ce moniteur peut faire perdre à l'utilisateur sont droit d'opération de cet appareil.

**Note:** Si nécessaire, des câbles d'interface protégés et un cordon d'alimentation alternante doivent être utilisé pour être conforme aux limites d'émission.

## Safety Precautions

Follow all warnings, precautions and maintenance as recommended in this user's manual to maximize the life of your unit.

### **Do:**

- Turn off the product before cleaning.
- LED Display screen surface may be cleaned using a soft clean cloth moistened with mild window glass commercial cleaners or 50/50 mixture of water and isopropyl alcohol.
- Use a soft cloth moistened with mild detergent to clean the display housing.
- Disconnect the power plug from AC outlet if the product is not going to be used for an extended period of time.

### **Don't:**

- Do not touch the LED Display screen surface with sharp or hard objects.
- Do not use abrasive cleaners, waxes or solvents for your cleaning.
- Do not operate the product under the following conditions:
  - Over 16 hours per day.
  - Extremely hot, cold or humid environment.
  - Areas susceptible to excessive dust and dirt.
  - Near any appliance generating a strong magnetic field.
  - In direct sunlight.
- If smoke, abnormal noise or odor emits from your LED LCD Monitor, remove the power cord immediately and call your service center.
- Never remove the rear cover of your LED LCD Monitor. The display unit inside contains high-voltage parts and may cause electric shock.
- Never try to repair your LED LCD Monitor yourself. Always call your service center or a qualified technician to fix it.
- Due to safety concerns, if the VESA mounting kit is purchased separately, please make sure the mounting kit is UL-listed, and replaceable only by service personnel.

## Consignes de sécurité

Respectez tous les avertissements, les précautions et conseils d'entretien recommandés dans ce manuel de l'utilisateur pour maximiser la durée de vie de votre appareil.

### **A faire :**

- Éteindre le produit avant de le nettoyer.
- La surface de l'écran tactile peut être nettoyée avec un chiffon doux et propre imprégné d'un nettoyant doux du commerce pour vitres ou d'un mélange à 50/50 d'alcool isopropylique et d'eau.
- Utilisez un chiffon doux imprégné d'un détergeant doux pour nettoyer le carter de l'affichage.
- Débranchez la fiche d'alimentation de la prise de courant secteur si le produit ne doit pas être utilisé pendant une période prolongée.

### **A ne pas faire :**

- Ne touchez pas la surface de l'écran LED avec des objets coupants ou durs.
- N'utilisez pas des produits de nettoyage abrasifs, de la cire ou des solvants pour le nettoyage.
- N'utilisez pas le produit dans les conditions suivantes :
  - Plus de 16 heures par jour.
  - Environnement extrêmement chaud, froid ou humide.
  - Endroits poussiéreux ou sales.
  - Près d'appareils générant un fort champ magnétique.
  - Sous la lumière directe du soleil.
- Si de la fumée, un bruit anormal ou une odeur s'échappait de votre moniteur LCD LED, débranchez immédiatement le cordon d'alimentation et appelez votre centre de réparation.
- Ne retirez jamais le couvercle arrière de votre moniteur LCD LED. L'unité d'affichage contient des éléments où circule un voltage élevé et présentant un risque d'électrocution.
- N'essayez jamais de réparer vous-même votre moniteur LCD LED. Faites toujours appel à votre centre de service ou à un technicien qualifié pour toute réparation.
- Pour des raisons de sécurité, si vous achetez séparément le kit de fixation VESA, assurez-vous que celui-ci est certifié UL, et qu'il peut être remplacé uniquement par un technicien qualifié.

## Package Overview

Congratulations on your purchase of this high performance LED edge lit, LCD monitor. This LED LCD Monitor comes with the following accessories:

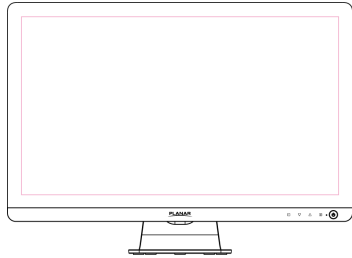

LED LCD Monitor

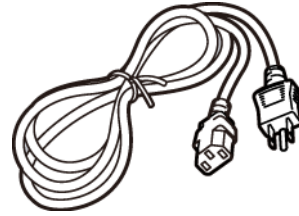

Power Cord

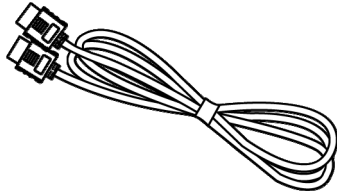

HDMI Cable

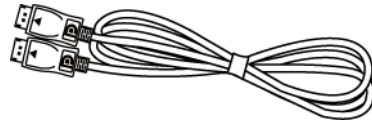

Display Port Cable

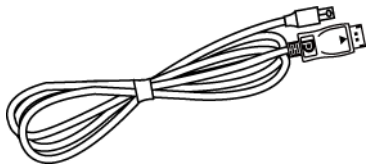

Mini DP to DP cable



User's Guide

## Front View of the Product

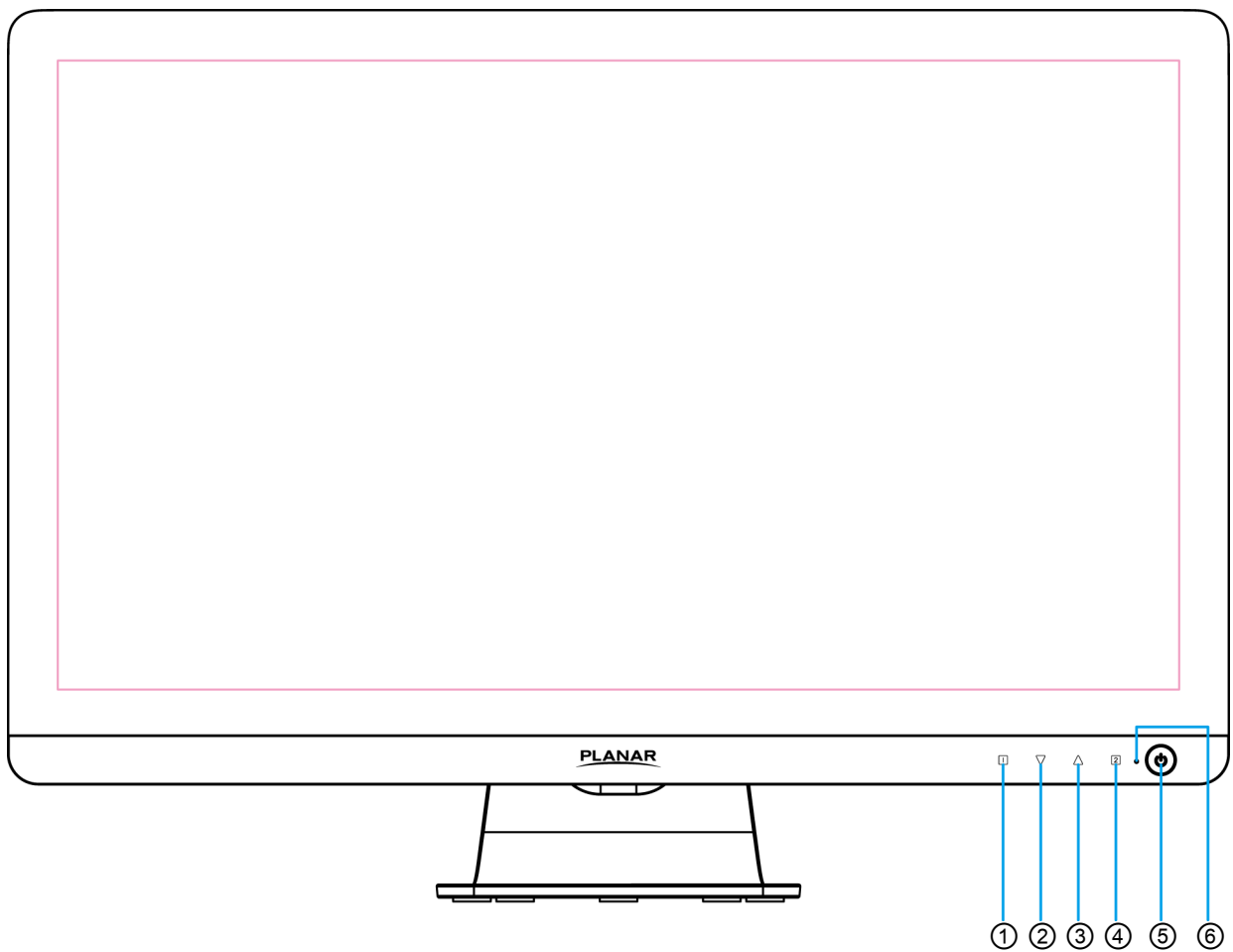

①	OSD Turn On/ Off
②	Scroll Down/ Adjust Decrease/ Preset Mode Menu*
③	Scroll UP/ Adjust Increase/ Audio Menu*
④	Input select/ Confirm Selection/ Blue Light Reducer*
⑤	Power On/Off
⑥	LED Indicator

\* Hot keys Instructions please see "Using the OSD Menu" on page 9.



## Rear View of the Product

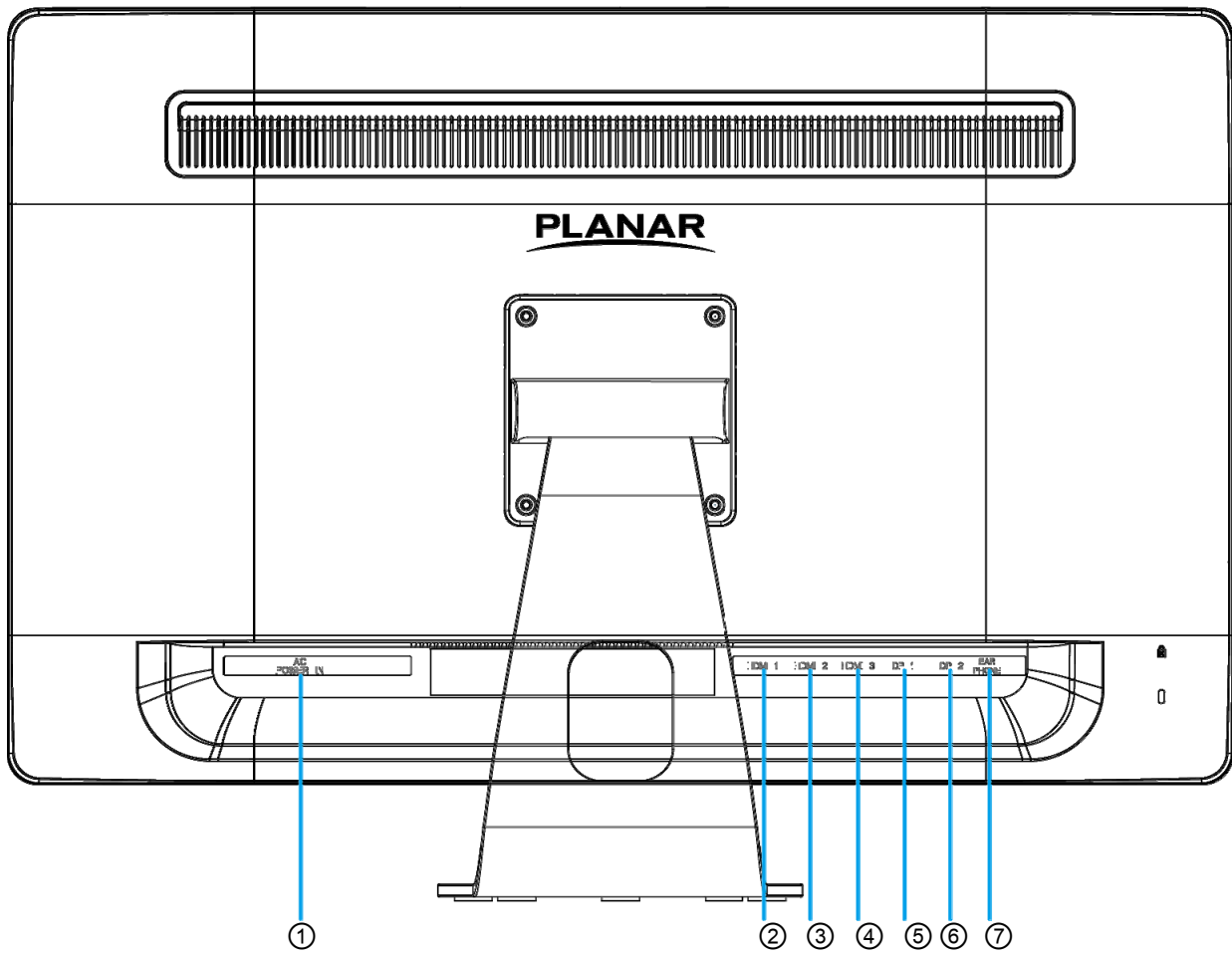

①	Power Input
②	HDMI 1 input (HDMI 19 pin)
③	HDMI 2 input (HDMI 19 pin)
④	HDMI 3 input (HDMI 19 pin)
⑤	Display Port 1 Input (Display Port 20 pin)
⑥	Display Port 2 Input (Display Port 20 pin)
⑦	Headphone Jack

## Quick Installation

1. Connect either HDMI or Display Port Video source from the monitor to the computer, using the included HDMI cable or Display Port cable. Make sure both monitor and computer are powered OFF.
2. Connect the earphone to the earphone output terminal of the monitor. (Earphone may be sourced separately from an earphone supplier)
3. Connect power cord to a properly grounded AC outlet, and then to the monitor.
4. Power-ON computer and then POWER-ON the monitor.
5. Set the timing mode on your computer. Recommended resolution and refresh rate is 5120 x 2880 @ 60Hz.

**Note:** HDMI input does not support 5120 x 2880 resolution. It is only supported on Display Port input, using a single Display Port cable. Check your hardware, operating system, content and graphics card for compatibility.

Figure 1:

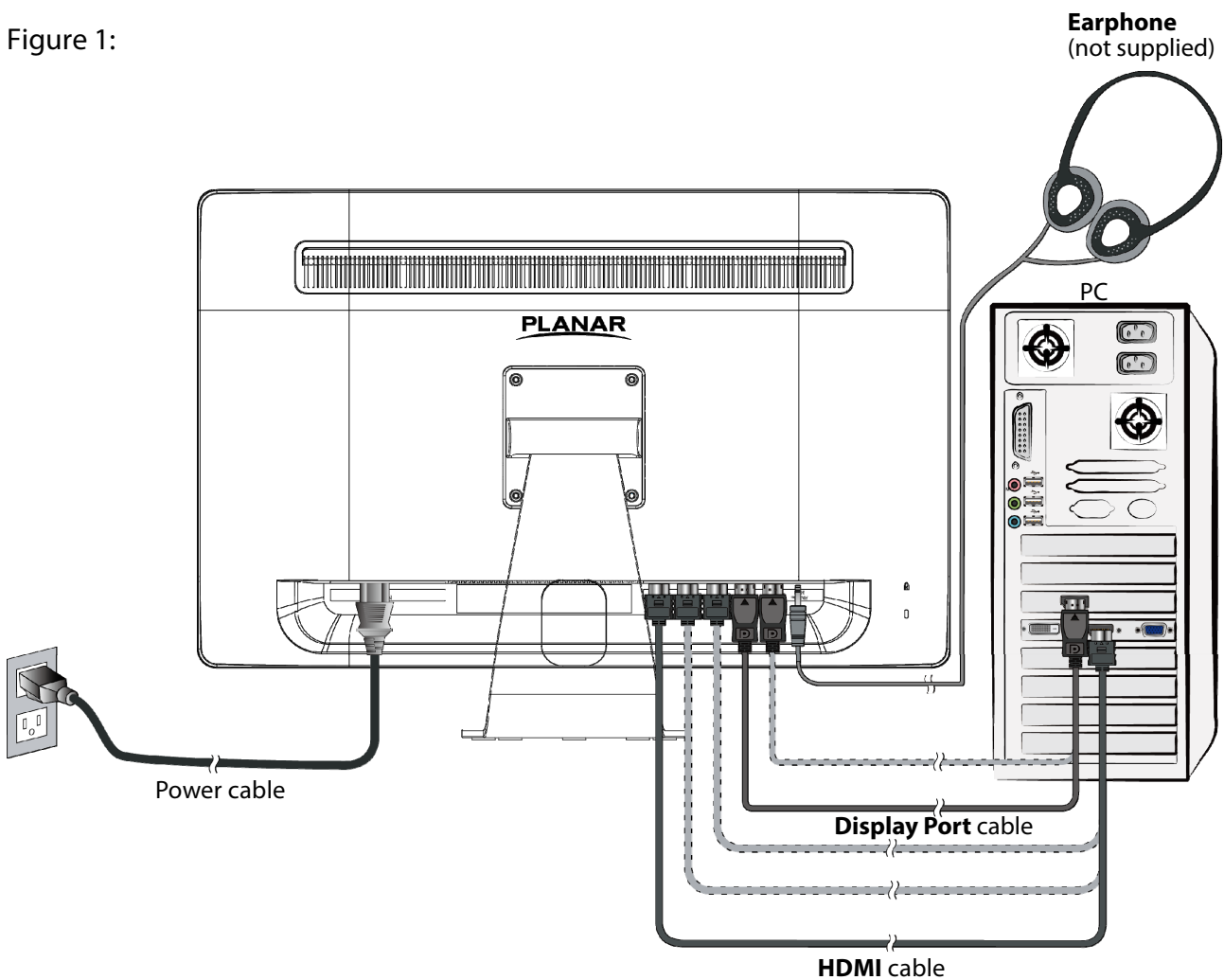

## Basic Operation

Before using the LED LCD Monitor:

- Connect external equipment properly.
- Insert the power plug, and the power LED indicator will light orange.

### Power On/Off

To turn the LED LCD Monitor on/off:

Press  Power button on the front of LED LCD Monitor. The power LED indicator light will be blue when the LED LCD Monitor is on.

### Using the OSD Menu



Use OSD menus to adjust settings by using the menu button on the front of the LED LCD Monitor.

1	Displays main menu
	Exits from OSD menu
2	Selects between HDMI1, HDMI2, HDMI3, DisplayPort 1, DisplayPort2 or Auto mode
	Press 2 seconds activates Blue Light Reducer Menu
▼	Select the desired item when in OSD menu
	When not in OSD menu, directly enters Preset Menu
▲	Select the desired item when in OSD menu
	When not in OSD menu, directly enters Audio menu
	When holding for 2 seconds activates Mute

### OSD Lock Out Function

When LED LCD Monitor is in normal mode, the “OSD Lock Out” function can be enabled.

**Option 1:** OSD lock – all 4 buttons are locked except the “POWER” button.

Press and hold the  button and the  button for 3 seconds to lock the OSD buttons.

The LED LCD Monitor will show an “OSD Locked” message for 3 seconds and the message will disappear automatically.

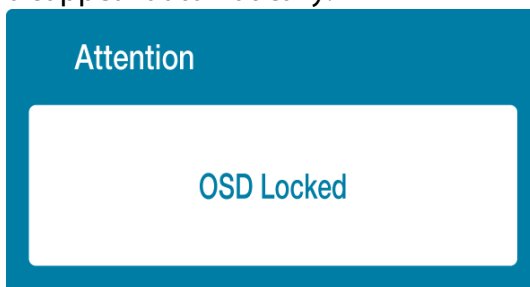

Repeat this step to unlock.

**Option 2:** OSD & Power button lock – all 5 buttons including the “POWER” button are locked. Press and hold the **1** button and the ▼ button for 3 seconds to lock all 5 buttons.

The LED LCD Monitor will show a “Power Button Locked” message for 3 seconds and the message will disappear automatically.

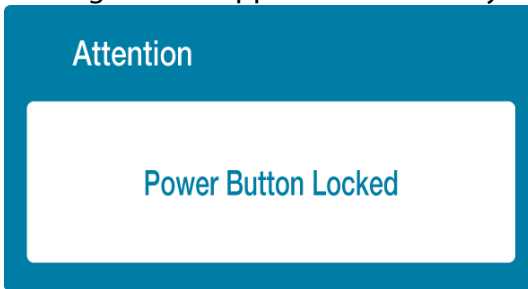

Repeat this step to unlock.

## Advanced Operation—OSD Menu

You can use the OSD menu to adjust various settings for your LED LCD Monitor.

Press the **1** button to display the OSD Menu, and use **▼** or **▲** to select the desired OSD menu. Press **2** to confirm or reach the next sub-menu. To exit press **1**.

### Short Cuts Function from the button(s)

**Input:** When Input Select is pressed, change Input signal to HDMI1, HDMI2, HDMI3, DisplayPort1, DisplayPort 2 or Auto.

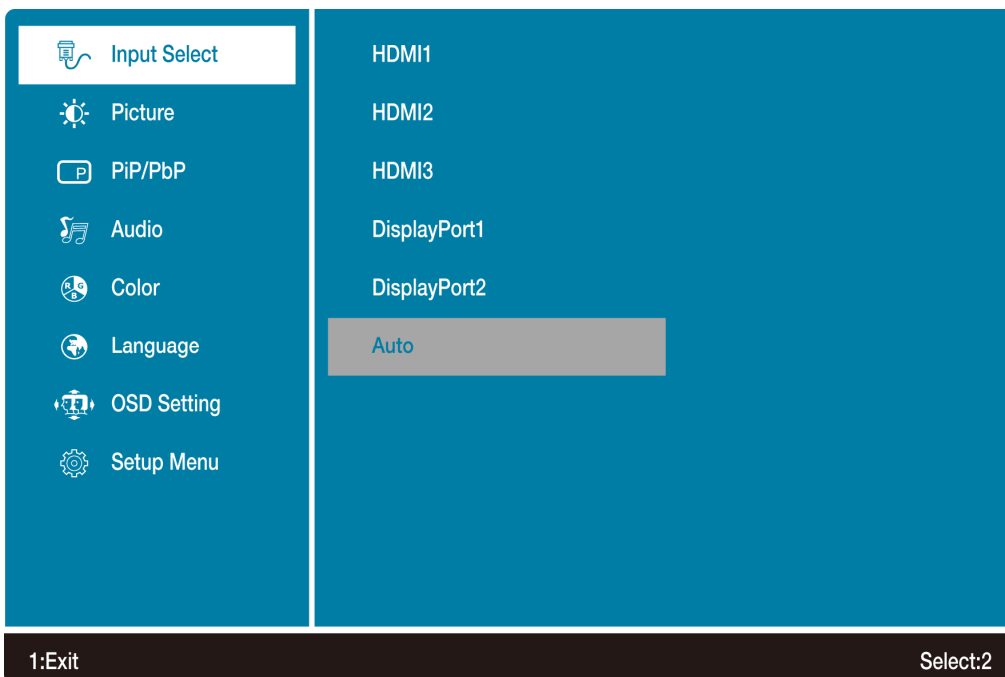

**Picture:** To manually adjust the Picture Format, Brightness, Contrast, Sharpness, Overdrive, ECO Mode and Super Resolution of screen image.

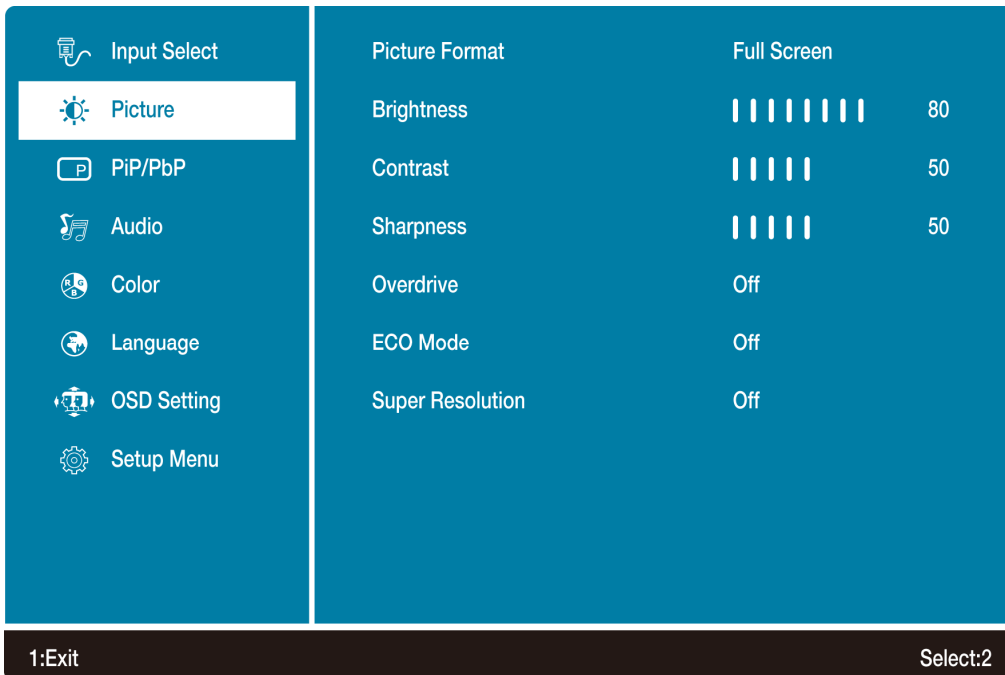

- **Picture Format:** To select the video mode from Full Screen, Aspect Ratio or Dot By Dot.
- **Brightness:** To adjust the luminance of the video.  
▲: increase brightness, ▼: decrease brightness.
- **Contrast:** To adjust the foreground white level of screen image.  
▲: increase contrast, ▼: decrease contrast.
- **Sharpness:** To adjust the clarity of a non-UHD Resolution (5120 x 2880) signal with ▲ or ▼ button.
- **Overdrive:** Allows the user to change the Over Drive strength to improve the quality of motion pictures.  
Press ▲ or ▼ key to adjust the Over Drive strength in five levels.
- **ECO Mode:** Allows the user to turn the ECO On or Off. Brightness and Blue Light Reducer adjustment will be disabled when ECO Mode is active.
- **Super Resolution:** Allows the user to enhance the picture quality when viewing video. Lower level for slow videos, higher level for fast video/games.  
Press ▲ or ▼ key to adjust the strength in three levels.

**PiP/PbP:** PiP/PbP button allows you to watch two screens from different sources at the same time. (PiP is picture in picture; PbP is picture by picture)



- **PiP/PbP Mode:** Toggle to enable/disable PiP/PbP function.  
**Main Input.** Identifies main source (greyed out)
- **Sub Win1 Input:** To select input source for sub-screen.
- **PiP Size:** To adjust sub-screen window size.

Small (1792 x 1008)	Middle (2048 x 1152)	Large (2304 x 1296)

- **PiP Position:** To adjust sub-screen window position.

Top-Right	Top-Left	Bottom-Right	Bottom-Left

- **Swap:** Switch between main screen and sub-screen (only for PiP and PbP)

## In PbP Mode

Splits the screen left and right equally. In order to achieve full screen on each side, recommended resolution is 2560 x 2880; however, this is a custom resolution. Check your video card to see if custom resolution is supported. If not supported, black bars on top and bottom will result.



**Audio Adjust:** To adjust the audio functions.

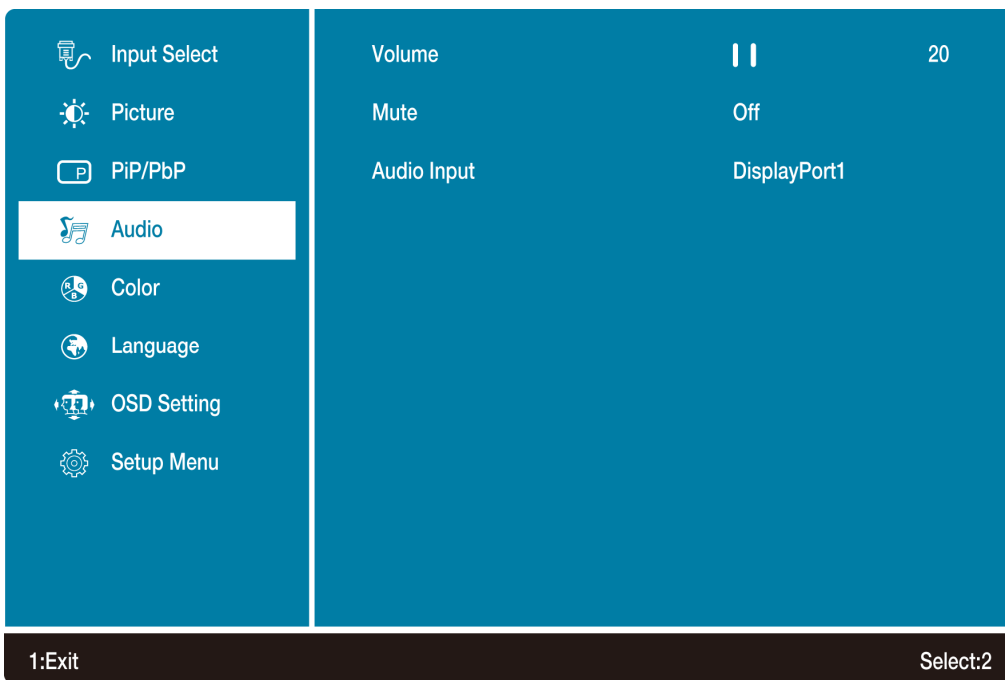

- **Volume:** To adjust the volume of speaker output.
- **Mute:** To turn the Mute ON/OFF.
- **Audio Input:** Default is main source, but can be manually switched in PiP and PbP mode.



**Color:** To select the color for improving brightness and color saturation between Warm, Normal, Cool, User Color, Preset Mode, and Blue Light Reducer.

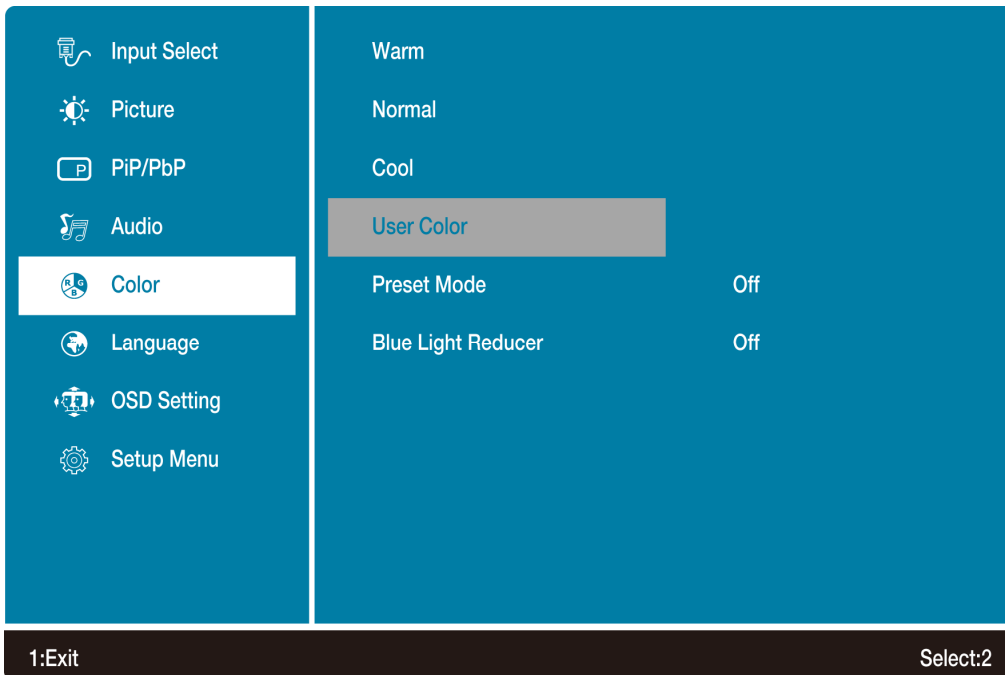

- **Warm:** Adds green to screen image for a darker color.
- **Normal:** Adds red to screen image for warmer white and richer red.
- **Cool:** Adds blue to screen image for cooler white.
- **User Color:** Individual adjustments for red (R), green (G), blue (B).
  1. Press button **2** to select the desired color.
  2. Press **▲** or **▼** button to adjust selected color.
- **Preset Mode:** Provides an optimum display environment depending on the content displayed. It contains 4 user-selectable presets. (Brightness, Contrast, ECO Mode and Blue Light Reducer adjustment will be disabled when Preset Mode is active.)
  - Standard** is for general windows environment and monitor default setting.
  - Scenery** optimized for displaying outdoor scenery images.
  - Cinema** optimized for movie and video environment.
  - Text** optimized for text editing and viewing in a word processing environment.
- **Blue Light Reducer:** To decrease the blue light emitted from the display to reduce the risk of blue light exposure to your eyes. (ECO Mode and Color Menu adjustment will be disabled when Blue Light Reducer is active.)
 

Press button **2** to select the Blue Light Reducer.

Press **▲** or **▼** key to adjust the Blue Light Reducer strength.

  - Video – Ideal for watching videos (15% reduction)
  - Web Browsing – Ideal for web browsing (30% reduction)
  - Reading – Ideal for reading (50% reduction)
  - Low Light – Ideal for low ambient lighting environments (70% reduction)

**Language:** Allows user to choose from available languages.



**OSD Setting:** To manually adjust the Horizontal and Vertical OSD position, OSD Background and OSD Time Out.

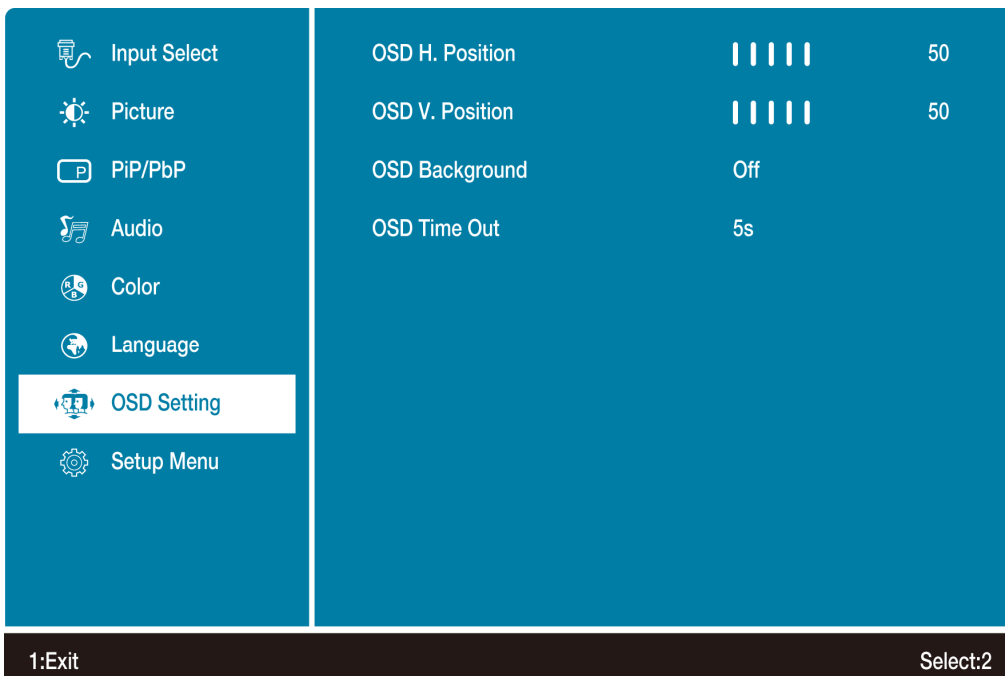

- **OSD H. Position:** To horizontally adjust the OSD position.
- **OSD V. Position:** To vertically adjust the OSD position.
- **OSD Background:** Allows the user to turn the OSD background On or Off.
- **OSD Time Out:** To automatically turn off On Screen Display (OSD) after a preset period of time.

**Setup Menu:** To set up DP Format, LED, Information and Reset.

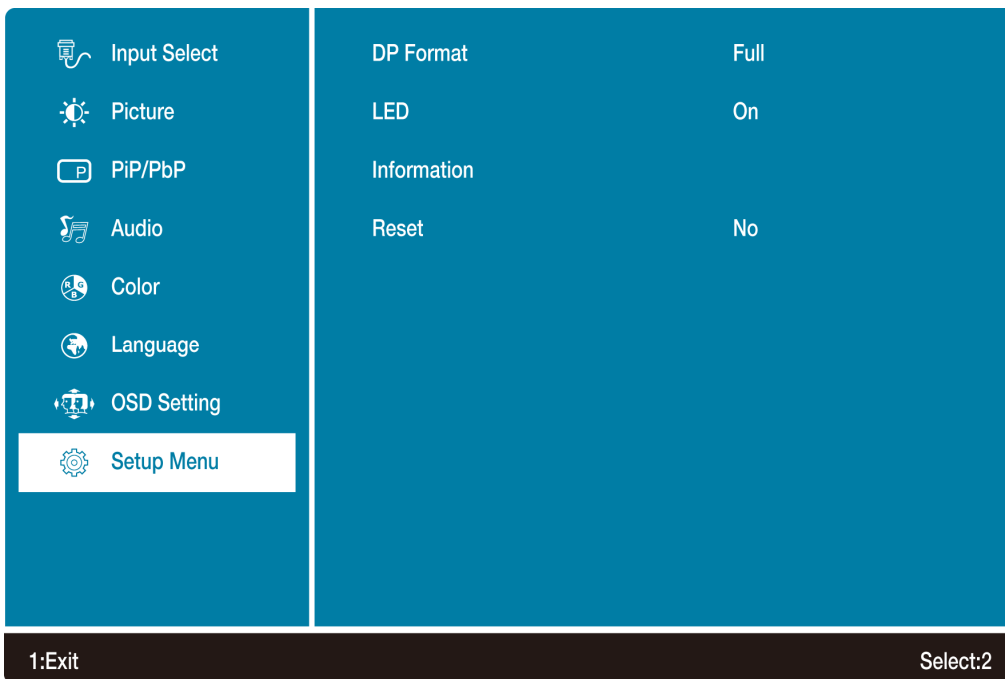

- **DP Format:** To adjust the DisplayPort bandwidth setting.
  - Full** : Set DP version to 1.4. The maximum resolution is 5120x2880 60Hz.
  - Limit** : Set DP version to 1.2. The maximum resolution is 3840x2160 30Hz.
- **LED:** Allows the user to turn the LED Indicator On or Off.
- **Information:** To display the information, regarding the current input signal coming from the graphic card in your computer.
  - Note:** See your graphic card user guide for more information about changing the resolution and refresh rate.
- **Reset:** To recall factory settings for Video & Audio controls.
  - Press button **2** to select the Memory Recall menu option.

## Supporting Timing Modes

STANDARD	RESOLUTION	STANDARD	RESOLUTION
VGA	720 x 400 @ 70Hz	CVT	1280 x 800 @ 60Hz
VGA	640 x 480 @ 60Hz	VESA	1280 x 1024 @ 60Hz
MAC	640 x 480 @ 67Hz	VESA	1280 x 1024 @ 75Hz
VESA	640 x 480 @ 72Hz	VESA	1600 x 900 @ 60RB
VESA	640 x 480 @ 75Hz	VESA	1680 x 1050 @ 60Hz
VESA	800 x 600 @ 56Hz	VESA	1920 x 1080 @ 60Hz
VESA	800 x 600 @ 60Hz	VESA	1920 x 1200 @ 60Hz
VESA	800 x 600 @ 72Hz	VESA	2048 x 1152 @ 60Hz
VESA	800 x 600 @ 75Hz	VESA	2560 x 1440 @ 60Hz
MAC	832 x 624 @ 75Hz	CVT	3840 x 2160 @ 24Hz
VESA	1024 x 768 @ 60Hz	CVT	3840 x 2160 @ 25Hz
VESA	1024 x 768 @ 70Hz	CVT	3840 x 2160 @ 30Hz
VESA	1024 x 768 @ 75Hz	CVT	3840 x 2160 @ 60Hz
MAC	1152 x 870 @ 75Hz	CVT (only DP)	5120 x 2880 @ 60Hz
VESA	1280 x 720 @ 60Hz		

**Note:**

HDMI and Display Port supports 480i, 480p, 720p, 1080i, 1080p, and 2160p.

**Warning:** Do not set the graphic card in your computer to exceed these maximum refresh rates. Doing so may result in permanent damage to your LED LCD Monitor.

**Avertissement :** Ne réglez pas la carte graphique de votre ordinateur en dépassant ces taux de rafraîchissement maximaux. Si vous le faites, cela va irrémédiablement détériorer votre moniteur.

## Technical Information

<b>Panel</b>	27" TFT (with LED backlight)	
<b>Power Management</b>	On: 50 Watts (typical), 75 Watts (maximum) Standby Mode: < 0.5 Watt Off: < 0.5 Watt	
<b>Displayable Resolution</b>	5K UHD 5120 x 2880 max. Vertical Frequency 60Hz max.	
<b>Compatibility</b>	<b>PC</b>	HDMI Support up to 3840 x 2160 DP support up to 5120 x 2880 (non-interlaced)
	<b>Mac®</b>	HDMI Support up to 3840 x 2160 DP Support up to 5120 x 2880
<b>Pixel Dimension</b>	0.11625 x 0.11625 mm	
<b>Display Color</b>	16.7M	
<b>Tilt</b>	-5°~25° (±2°)	
<b>Active Display Area</b>	595.2 mm x 334.8 mm	
<b>Temperature</b>	Operating: 0°C ~ +40°C Storage: -20°C ~ + 60°C	
<b>Compliance</b>	FCC-B, CE, UL/cUL	
<b>Power</b>	Input Voltage AC100-240 V	
<b>Audio Output</b>	2W x 2	

## Wall-Mount Installation Instructions

### Preparing To Install The Optional Wall Mount Arm (not included)

This LED LCD Monitor can be attached to a wall mounting arm you can purchase separately.

Turn the power OFF then disconnect the cables from the LED LCD Monitor before performing the procedure below.

1. Lay the LED LCD Monitor face down on a soft surface.
2. Remove the 4 screws holding the stand to the hinge.
3. Remove the stand.

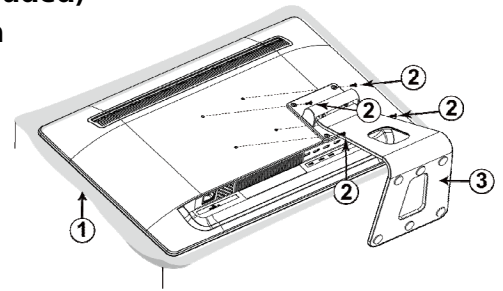

### Attaching The Optional Wall Mount Arm (not supplied)

Follow these steps to finish installing the wall mounting arm:

1. Place the wall mounting arm onto the back of the LED LCD Monitor. Line up the holes of the arm with the holes in the back of the monitor.
2. Insert the 4 screws into the holes and tighten.
3. Reconnect the cables. Refer to the User's Guide that came with the optional wall mounting arm for instructions on attaching it to the wall.

100mm x 100mm Screw Mounting Options

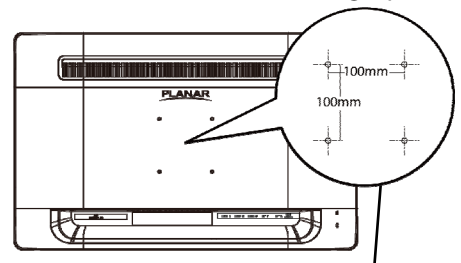

4mm, 0.7 pitch threaded holes x 4

### NOTE

- 100mmx100mm VESA high hole (n=4), M4, pitch =0.7 mm screw mounting kit not included.

## **Troubleshooting**

### **No power**

- Make sure A/C power cord is securely connected to the power supply is firmly connected to the LED LCD Monitor.
- Plug another electrical device into the power outlet to verify that the outlet is supplying proper voltage.
- Make sure all signal cables are installed.

### **Power on but no screen image**

- Make sure the video cable supplied with the LED LCD Monitor is tightly secured to the video output port on back of the computer. If not, tightly secure it.
- Adjust brightness.

### **Wrong or abnormal colors**

- If any colors (red, green, blue) are missing, check the video cable to make sure it is securely connected. Loose or broken pins in the cable connector could cause an improper connection.
- Connect the LED LCD Monitor to another computer.

### **5K UHD resolution not supported**

- Make sure your hardware, operating system, content, and graphics card supports up to 5120 x 2880 resolution.
- Only use Display Port inputs and cables. HDMI inputs and cables are not supported.

## **Planar Support**

### **Cables and Accessories**

To find cables and accessories for your Planar monitor, touch screen or other Planar products visit our online store at [www.PlanarOnline.com](http://www.PlanarOnline.com).

### **Technical Support**

Visit Planar at <http://www.planar.com/support> for operations manuals, touchscreen drivers, warranty information and access to Planar's Technical Library for online trouble shooting. To speak with Planar Customer Support please have your model and serial number available and dial:

### **Planar Support**

Tel: 1-866-PLANAR1 (866-752-6271) or +1 503-748-5799 outside the US.

Hours: 24 hours a day, 7 days a week.

Toll or long distance charges may apply.



## **Planar, a Leyard company**

Customer Service

24x7 Online Technical Support: <http://www.planar.com/support>

1195 NW Compton Drive

Beaverton, OR 97006-1992

Tel: 1-866-PLANAR1 (866-752-6271), or +1 503-748-5799 outside the United States,

Hours: 24 hours a day, 7 days a week

© 11/2017 Planar, a Leyard company.

Planar is a registered trademark of Planar, a Leyard company. Other brands and names are the property of their respective owners. Technical information in this document is subject to change without notice.

300110001716000

