

Planar PS Series User Guide



PS4662T
PS5562
PS5562T
PS6562

Copyright © 26 Jan 2017 by Planar Systems, Inc. All rights reserved.

Contents of this publication may not be reproduced in any form without permission of Planar Systems, Inc.

Trademark Credits

Windows™ is a trademark of Microsoft Corp.

All other companies are trademarks or registered trademarks of their respective companies.

Disclaimer

The information contained in this document is subject to change without notice. Planar Systems, Inc. makes no warranty of any kind with regard to this material. While every precaution has been taken in the preparation of this manual, the Company shall not be liable for errors or omissions contained herein or for incidental or consequential damages in connection with the furnishing, performance, or use of this material.

Warranty and Service Plans

Planar warranty and service plans will help you maximize your investment by providing great support, display uptime, and performance optimization. From post-sale technical support to a full suite of depot services, our services are performed by trained Planar employees. When you purchase a Planar product, you get more than a display, you get the service and support you need to maximize your investment. To find the latest warranty and service information regarding your Planar product, please visit <http://www.planar.com/support>

Part Number: 020-1328-00A

Contents

Planar PS Series User Guide	i
Introduction	1
Safety Information	2
Safety Precautions.....	2
Recommended Usage.....	4
VESA Mounts, General Description.....	6
Cleaning the Display	7
Package Contents	8
Planar PS Series - Standard Inputs.....	10
Installing the Display	11
Before You Begin.....	11
Operating the Display	12
OSD Keypad.....	12
Remote Control Receiver	13
LED Indicators.....	14
Using the Display in Portrait Mode.....	14
Using the Display in Flat or Tilted Orientation	14
Using the Remote Control	15
Turning the Display On.....	18
Turning the Display Off.....	18
Adjusting the Volume	18
Selecting the Input Source.....	18

Navigating Through the Menus.....	19
Using the Touch Screen	34
LAN Control	35
Supported Operating Systems.....	35
Installation.....	36
Configuring VCOM	39
Function Descriptions	41
Setting Up Email Alerts	45
Login	45
Administrator	47
TCP Mode, UDP Mode and UART.....	50
SMTP	50
Reset Device	51
Signal Compatibility	52
Specifications	54
Dimensions	56
PS4662T	56
PS5562	57
PS5562T	58
PS6562	59
Troubleshooting	60
Symptoms, Possible Causes and Solutions	60
Accessing Planar’s Technical Support Website	62

Introduction

Ranging in size from 46" – 65", the Planar® PS Series is a line of professional large format Full HD (1080p) LCD displays that features narrow bezels and integrated touch options. Engineered from the ground up for extended commercial use, each Planar PS Series model is recommended for up to 24x7 operation and comes standard with a durable metal bezel. At double the brightness of standard televisions, Planar PS Series LCD displays deliver vibrant images that will captivate the attention of any audience. Planar PS Series displays also feature the latest in LED backlight technology, enabling each to operate at lower power, thereby reducing total cost of ownership.

Planar PS Series 46" and 55" displays can be transformed into fully integrated touch displays to create interactive experiences for public information, wayfinding, corporate collaboration, and other applications. These displays offer precise multi-touch technology featuring a slim profile and a protective glass seal designed to keep dust, dirt, and moisture away from the display.

Planar PS Series displays are logo-free, allowing the spotlight to shine on the display screen. Unbranded bezels are perfect for portrait installations and are only available from Planar.

From its comprehensive commercial-grade features to its integrated touch display options, Planar PS Series LCD displays are sure to please with features including:

- Sizes range from 46" – 65"
- Designed for 24x7 operation
- Comprehensive set of inputs and control
- Logo-free, durable metal bezel
- Fully integrated multi-touch models available

Caution: This manual is intended for use by qualified service persons and end users with experience installing LCD displays.

Safety Information

Before using the Planar PS Series, please read this manual thoroughly to help protect against damage to property, and to ensure personnel safety.

- Be sure to observe the following instructions.
- For your safety, be sure to observe ALL the warnings detailed in this manual.
- For installation or adjustment, please follow this manual's instructions, and refer all servicing to qualified service personnel.

Safety Precautions

- **If water is spilled or objects are dropped inside the display, remove the power plug from the outlet immediately.** Failure to do so may result in fire or electrical shock. Contact your dealer for inspection.
- **If the display is dropped or the chassis is damaged, remove the power plug from the outlet immediately.** Failure to do so may result in fire or electrical shock. Contact your dealer for inspection.

WARNING! Wall mounts must be secure.

- **If the display is hung on a wall, the wall must be strong enough to hold it.** Simply mounting it to wallboard or wall paneling won't be adequate or safe.

Caution: The screen could be damaged by heavy pressure.

- **Slight pressure on the LCD will cause distortion of the image.** Heavier pressure will cause permanent damage. Displays should be mounted where viewers cannot touch the screen or insert small objects in the openings that will create hazards by contacting bare conductive parts.

Caution: The front polarizer is soft and subject to scratches from sharp objects.

- **The polarizer is a thin sheet of film laminated to the outside layer of glass on the LCD screen.** Take care when handling items near the screen.
- **If the power cord or plug is damaged or becomes hot, turn off the main power switch of the display. Make sure the power plug has cooled down and remove the power plug from the outlet.** If the display is still used in this condition, it may cause a fire or an electrical shock. Contact your dealer for a replacement.

Important Safety Instructions

- 1** Read these instructions.
- 2** Keep these instructions.
- 3** Heed all warnings.
- 4** Follow all instructions.
- 5** Do not use the display near water.
- 6** Clean the LCD screens with an LCD screen cleaner or LCD wipes.
- 7** Do not install near any heat sources such as radiators, heat registers, stoves or other apparatus (including amplifiers) that produce heat.
- 8** Do not defeat the safety purpose of the polarized or grounding type plug. A polarized plug has two blades with one wider than the other. A grounding type plug has two blades and a third grounding prong. The wide blade or the third prong is provided for your safety. When the provided plug does not fit into your outlet, consult an electrician for the replacement of the obsolete outlet.
- 9** Protect the power cord from being walked on or pinched, particularly at plugs, convenience receptacles and the point where they exit from any of the displays.
- 10** Only use the attachments/accessories specified by the manufacturer.
- 11** Unplug all displays during lightning storms or when unused for long periods of time.
- 12** You must follow all National Electrical Code regulations. In addition, be aware of local codes and ordinances when installing your system.
- 13** Refer all servicing to qualified service personnel. Servicing is required when any of the displays have been damaged in any way. For example, if the AC power cord or plug is damaged, liquid has been spilled or objects have fallen into a display, the displays have been exposed to rain or moisture, do not operate normally or have been dropped.
- 14** Keep the packing material in case the equipment should ever need to be shipped.
- 15** Wall mounts must be secure. The wall must be strong enough to hold all displays, brackets and cables.

- 16** Slight pressure on the LCD will cause distortion of the image. Heavier pressure will cause permanent damage. Displays should be mounted where viewers cannot touch the screen or insert small objects in the openings that will create hazards by contacting bare conductive parts.
- 17** The front polarizer is soft and subject to scratches from sharp objects. The polarizer is a thin sheet of film laminated to the outside layer of glass on the LCD screen. Take care when handling items near the screen.

Recommended Usage

In order to get the most out of your LCD, use the following recommended guidelines to optimize the display.

Burn-In Versus Temporary Image Retention

Burn-in causes the screen to retain an image essentially forever, with little or no way to correct the problem. Under normal use, an LCD will not experience burn-in, as plasma displays do, nor will it retain images in any way.

Normal use of an LCD is defined as displaying continuously changing video patterns or images. However, LCDs can experience *temporary* image retention when recommended usage guidelines are not followed.

What is Temporary Image Retention?

Temporary image retention (TIR) can occur when a static image is displayed continuously for extended periods of time (12 hours or longer). An electrical charge differential may build up between the electrodes of the liquid crystal, which causes a negative-color video image (color-inverted and brightness-inverted version of the previous image) to be retained when a new image is displayed. This behavior is true for any LCD device from any LCD manufacturer.

TIR is not covered under warranty. See standard warranty terms and conditions for details. Here are some guidelines to help you avoid TIR:

- Use the LCD to show a screen saver, moving images or still pictures that change regularly. When using high-contrast images, reposition the images frequently.
- Turn off the LCD when it is not in use. To use your source computer's Power Options Properties, set up your computer to turn off the display when not in use.

Warranty Coverage

The following models are warranted for **24 x 7** usage:

- 46": PS4662T
- 55": PS5562, PS5562T
- 65": PS6562

Planar recommends turning off the power for **4 hours per day** for optimal performance.

For complete warranty details, please visit www.planar.com/warranty.

Important Waste Disposal Information

Please recycle or dispose of all electronic waste in accordance with local, state, and federal laws. Additional resources can be found online at <http://www.planar.com/about/green/>.

The crossed-out wheeled bin symbol is to notify consumers in areas subject to Waste Electrical and Electronic Equipment (WEEE) Directive 2012/19/EU that the product was placed on the market after August 13, 2005 and must not be disposed of with other waste. Separate collection and recycling of electronic waste at the time of disposal ensures that it is recycled in a manner that minimizes impacts to human health and the environment. For more information about the proper disposal of electronic waste, please contact your local authority, your household waste disposal service, or the seller from whom you purchased the product.



Normal Usage Guidelines

Normal use of the LCD is defined as operating in the open air to prevent heat buildup, and without direct or indirect heat sources such as lighting fixtures, heating ducts, or direct sunlight that can cause the modules to experience high operating temperatures. For all modules, do not block fans or ventilation openings. If the LCD module will be installed in a recessed area with an LCD surround or enclosure, ensure adequate openings are applied for proper air flow and ventilation.

At 3000 meters or below, the maximum ambient operating temperature for the LCD module cannot be above 40° C nor below the minimum ambient operating temperature of 0° C. If one of these conditions exists, it is up to the installer to ensure that module placement is changed, thermal shielding is provided and/or additional ventilation is provided to keep the display within its nominal operating parameters.

Cooling Requirements

For optimal performance, active cooling by the installer should be planned for when the ambient temperature at the top of the wall is predicted to be above the specified ambient temperature for the panel. Cooling may be done behind the displays and depending on the wall configuration, it may be helpful to place air ducts (AC) at every third display tall.

VESA Mounts, General Description

VESA mounts are used to secure the Planar PS Series for display. The display can be installed using a variety of VESA mounts available through Planar. If you do not have a VESA mount and would like to purchase one, contact Planar.

If you purchased a VESA mount, you should have received a separate box with mounting supplies and an Installation manual. Follow these instructions carefully.

Keep in mind the following general installation guidelines:

- Screw length is crucial and will vary depending on the type of mount you use. Total screw length will include the penetration length plus the length required by the type of VESA mount in use.

Caution: Shorter screws will result in insufficient mounting strength and longer screws could puncture parts inside the display.

- Prior to installation, make sure you know where all of the mounting points are located.
- Follow all safety precautions outlined in the VESA Installation manual.
- Verify the parts received with the list shown in the VESA Installation manual.

Cleaning the Display



If dust has collected on the power plug, remove the plug from the outlet and clean off the dust. Dust build-up may cause a fire.



Remove the power plug before cleaning. Failure to do so may result in electrical shock or damage.

Keep the following points in mind when cleaning the surface of the display:

- When the surface of the display becomes dirty, wipe the surface lightly with a soft clean cloth.
- If the surface requires additional cleaning, use LCD screen cleaner or LCD wipes, which are available at most electronics stores.
- Do not let cleaner seep into the display, as it may cause electrical shock or damage.

Package Contents

Part	Description	Number	Picture
LCD display	One per box.	1	
HDMI cable	HDMI cable.	1	
USB cable	Connects to a PC for touch functionality (touch models only).	1	
AC power cord	Power cord.	1	
IR extender cable	Used to receive signals from the remote control.	1	

Part	Description	Number	Picture
Remote control	Used to control the display (AAA batteries included).	1	
Quick Start Guide	Quick Start Guide.	1	

Planar PS Series - Standard Inputs

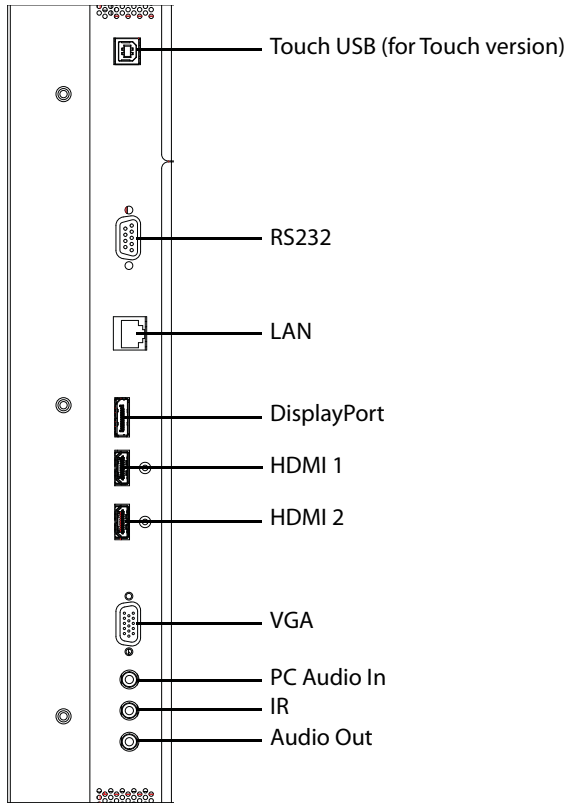

Installing the Display

This section explains how to install your display. We suggest that you read the entire section before you attempt to install the unit.

Before You Begin

Make sure you have all the items in these lists before you begin unpacking and installing your display(s).

Tools/Equipment List

Depending on your installation, you may need one or more of the following items:

- String/string level
- Digital/laser level
- Ladders/lift
- Back brace
- Stud finder (if hanging display on a wall)

Other Things You May Need

- LCD screen cleaner or LCD wipes - available at most electronics stores
- At least two very strong people to help lift units into place

Plan Your Installation

You should have a detailed plan of how the units are to be configured. The plan should include calculations for the following:

- Power (maximum of five units per 20A circuit for 115V operation)
- Cable runs
- Ventilation and cooling requirements
- If hanging display on a wall, location of studs in the wall

Prepare Your Installation Location

You should have prepared the area where you will install the unit. If custom enclosures are part of the installation, they must be fully designed to accommodate the installation of the displays, as well as the installed unit and ventilation and cooling requirements.

If your installation included a lot of construction or dust, it is **highly recommended** that you clean all of the screens after the wall installation and configuration are complete.

Operating the Display

OSD Keypad

The OSD keypad is located on the rear of the display.

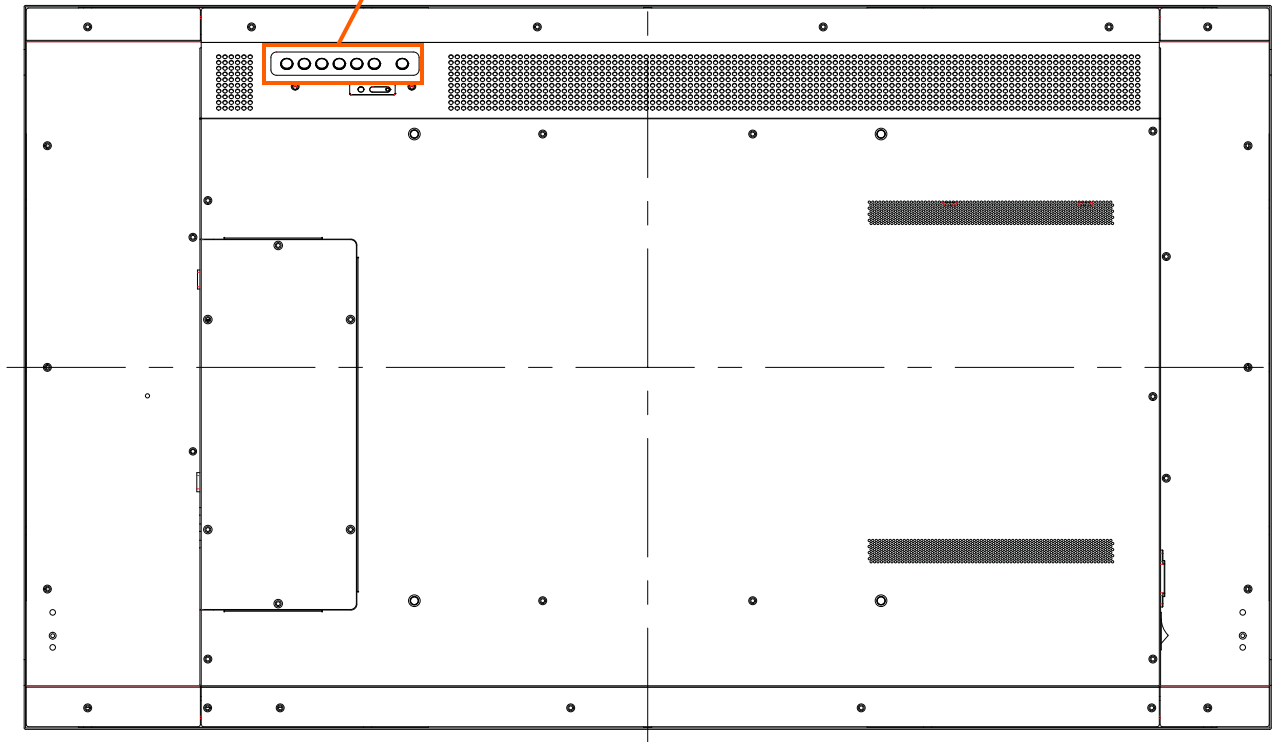

OSD Keypad Buttons

Key	Descriptions
Power	Power on/Power off
Source	Source selection (toggle)
▶	Menu Right/Increase value
◀	Menu Left/Decrease value
▲	Menu Up
▼	Menu Down
Menu/Exit	Menu/Exit

Remote Control Receiver

The remote control receiver is located near the keypad on the rear of the display. Use the IR extender cable for operating the remote from the front of the display.

Power ON standby indicator,
Remote control receiver

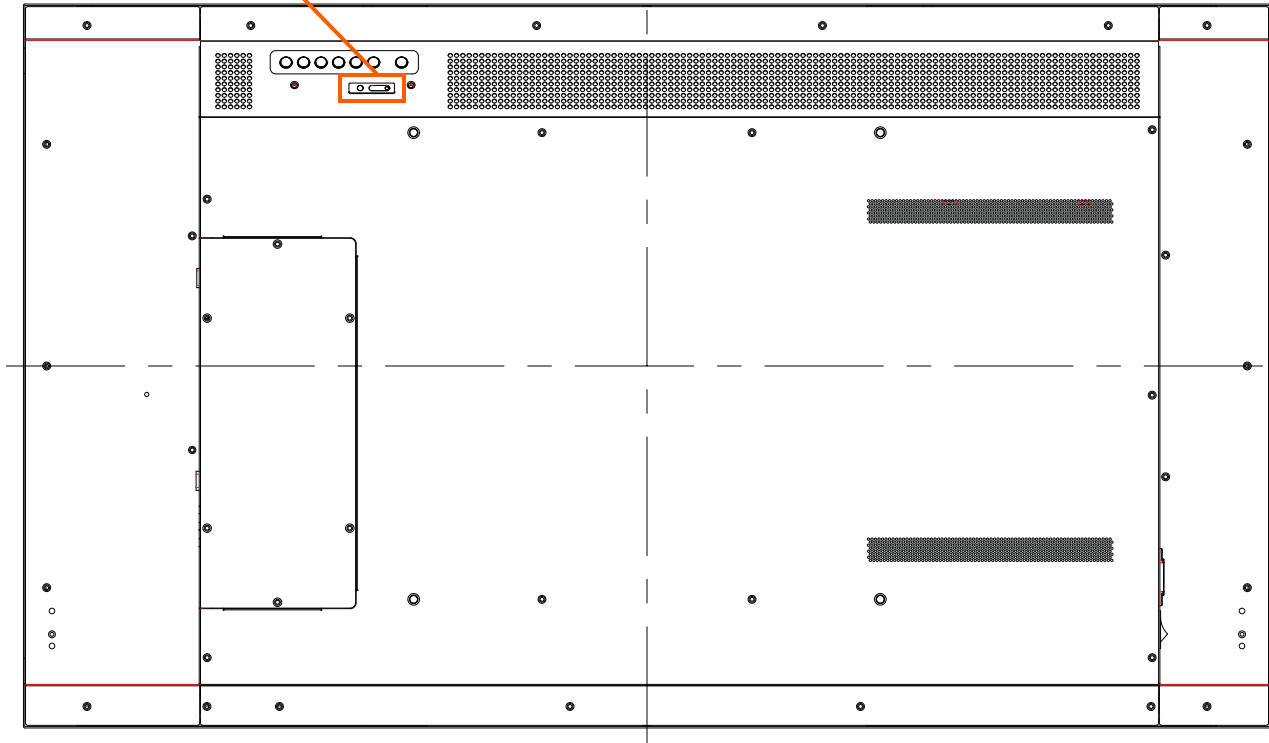

LED Indicators

The LED indicator light is located on the rear of the display near the keypad. The following table explains what the different colors and blink patterns mean.

LED On

Power Status	Condition
Green	Power on
Blinking Orange	No signal
Orange	Power saving mode
Off	AC off
Off	Power off

Using the Display in Portrait Mode

When using the display in the portrait position and looking at the rear of the display, it should be rotated according to the arrow stickers on the back of the display. This will allow for proper ventilation. Then select the OSD rotation of landscape or portrait on the OSD menu (MAIN MENU > BASIC > OSD ROTATION).

Caution: Improper ventilation may shorten the life of the display.

Using the Display in Flat or Tilted Orientation

The display is not recommended for use in flat orientation for tabletop, floor, or ceiling installations. LCD panels of this size are at risk of panel deflection, which can cause cosmetic sagging, brightness uniformity issues, a shortened life span, and malfunction of optional touch sensors. Installations where the display is tilted downward or upward at an angle may also be prone to these issues and are not recommended.

Using the Remote Control

Below is a picture of the remote control and its corresponding Hex codes. See the following page for button descriptions and Hex codes.

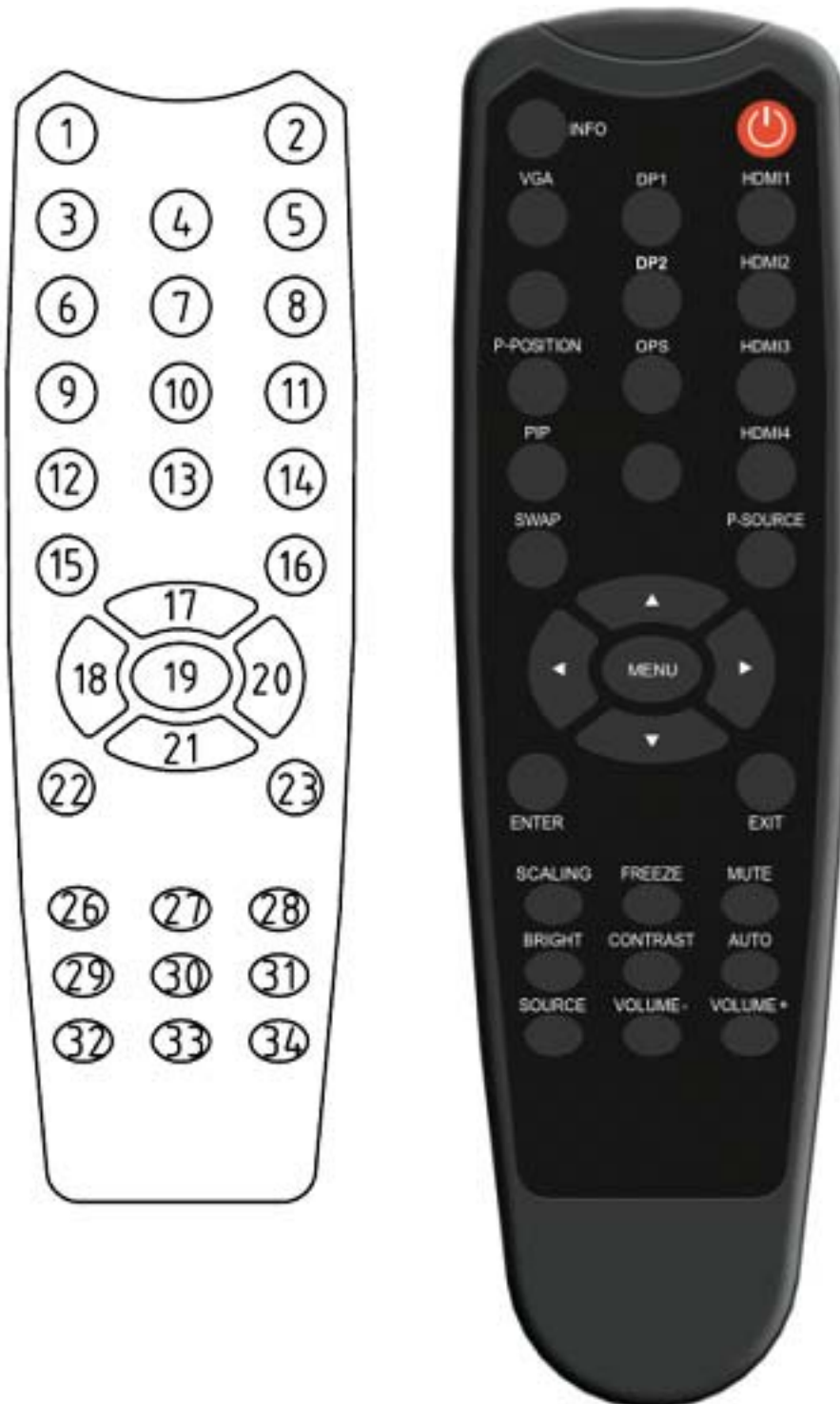

Remote Control Button Name	Address	Data	NEC Data From Remote (Hex Code)	Description
INFO	16559	4	0x40AF04FB	Opens the Information menu
POWER	16559	28	0x40AF1CE3	Power toggle
VGA	16559	7	0x40AF07F8	Selects the VGA input
DP 1	16559	8	0x40AF08F7	Selects the DP input
HDMI 1	16559	9	0x40AF09F6	Selects the HDMI 1 input
[No label]	16559	10	0x40AF0AF5	Not used
DP 2	16559	11	0x40AF0BF4	Not used
HDMI 2	16559	12	0x40AF0CF3	Selects the HDMI 2 input
PIP POSITION	16559	26	0x40AF1AE5	Not used
OPS	16559	21	0x40AF15EA	Not used
HDMI 3	16559	16	0x40AF10EF	Not used
PIP	16559	17	0x40AF11EE	Not used
[No label]	16559	13	0x40AF0DF2	Not used
HDMI 4	16559	22	0x40AF16E9	Not used
SWAP	16559	6	0x40AF06F9	Not used
PIP SOURCE	16559	19	0x40AF13EC	Not used
▲	16559	2	0x40AF02FD	Navigate up
◀	16559	1	0x40AF01FE	Navigate left
MENU	16559	14	0x40AF0EF1	Opens the menu
▶	16559	3	0x40AF03FC	Navigate right
▼	16559	25	0x40AF19E6	Navigate down
ENTER	16559	18	0x40AF12ED	Selects the current menu item
EXIT	16559	5	0x40AF05FA	Exits the menu
SCALING	16559	20	0x40AF14EB	Aspect ratio toggle
FREEZE	16559	67	0x40AF43BC	Not used
MUTE	16559	0	0x40AF00FF	Audio mute
BRIGHTNESS	16559	23	0x40AF17E8	Opens the Brightness slider
CONTRAST	16559	24	0x40AF18E7	Opens the Contrast slider
AUTO	16559	30	0x40AF1EE1	Auto adjust on VGA
SOURCE	16559	15	0x40AF0FF0	Opens the source menu
VOLUME -	16559	27	0x40AF1BE4	Volume decrease
VOLUME +	16559	29	0x40AF1DE2	Volume increase

Locking/Unlocking the OSD Menu

You can lock or unlock the OSD menu by pressing a series of key commands on the remote control. To **lock** the menu, press the following keys on the remote in the order listed: ENTER, ENTER, EXIT, EXIT, ENTER and EXIT. To **unlock** it, simply follow the same sequence.

Depending on whether you locked or unlocked the menu, you will see one of the following messages on the screen.

Key Unlocked

Key Locked

Changing the Remote Control Battery

- 1 Remove the battery cover.**
Slide back and remove the battery cover in the direction of the arrow.

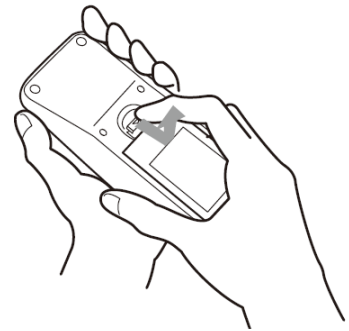

- 2 Insert the batteries.**
Align and insert two AAA batteries according to their plus and minus ports (as indicated in the remote control).

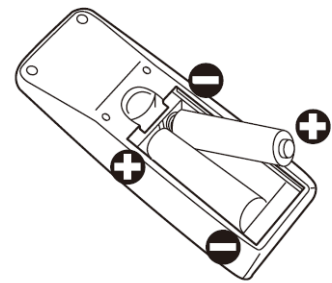

- 3 Close the battery cover.**
Replace the battery cover in the direction of the arrow and snap it back into place.

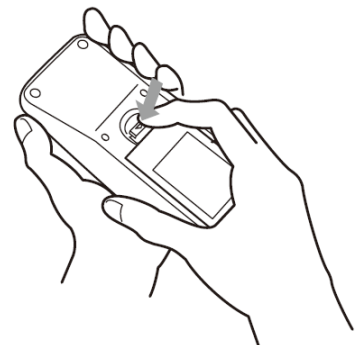

Turning the Display On

- 1 Insert the power cord into the display and into the power outlet.
- 2 Ensure the AC switch is set to “—”.
- 3 Press the power button on the remote or side control panel.

Turning the Display Off

With the power on, press the power button on the remote or side control panel to put the LCD panel in a standby mode. To turn off power completely, turn the AC switch to “O” or disconnect the AC power cord from the power outlet.

Note: If there is no signal for a certain period of time, the LCD panel will automatically go into standby mode.

Adjusting the Volume

- 1 Using the remote, press the VOLUME - or VOLUME + to increase or decrease the volume.
- 2 Press the MUTE button to temporarily turn off all sound. To restore the sound, press the MUTE button again.

Note: The analog audio out is variable.

Selecting the Input Source

Do one of the following:

- Using the remote, press the desired source button (DP1, HDMI1, HDMI2, VGA).
- Press the source button on the display’s keypad. Use the arrow buttons (▲▼) to select one of the following input sources and press ENTER: VGA, HDMI1, HDMI2, DISPLAYPORT.

Note: When the display cannot find a source, a “No signal” message will appear.

Navigating Through the Menu

- 1 With the power on, press MENU. The INPUT menu appears.
- 2 Within the menu, use ▲, ▼, ◀, ▶ and ENTER to navigate through the menus and adjust options.
- 3 Press MENU to return to the previous menu. To exit the menu system, press EXIT.

Video Menu

This menu is used for making common image adjustments.

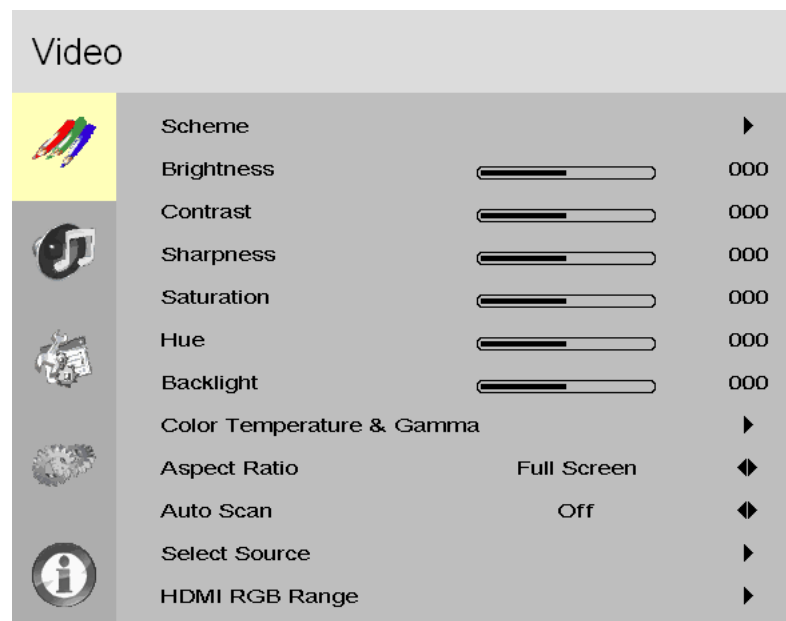

Scheme

Press ◀ or ▶ to select one of the following:

Options: User, Vivid, Cinema, Game, Sport; **Default:** User

Brightness

Increase or decrease the brightness of picture. Press ◀ or ▶ to select the desired level.

Range: 0~100; **Default:** 50

Contrast

Increase or decrease the contrast of picture. Press ◀ or ▶ to select the desired level.

Range: 0~100; **Default:** 50

Sharpness

Adjust the definition of picture. Press ◀ or ▶ to select the desired level.
Range: 0~8; **Default:** 6

Saturation

Adjust the brilliance and brightness. Press ◀ or ▶ to select the desired level.
Range: 0~100; **Default:** 50

Note: This function is not available when displaying PC or graphics sources.

Hue

Increase or decrease the green hue. Press ◀ or ▶ to select the desired level.
Range: 0~100; **Default:** 50

Note: This function is not available when displaying PC or graphics sources.

Backlight

Increase or decrease the intensity of the LCD backlight. Press ◀ or ▶ to select the desired level.
Range: 0~100; **Default:** 80

Color Temperature & Gamma

Select gamma.

Options: Off, 1.85, 1.9, 1.95, 2.0, 2.05, 2.10, 2.15, 2.2, 2.25, 2.3, 2.35, 2.4, 2.45, 2.5, 2.55, 2.6
Default: 2.2

Select color temperature.

Options: User, 3200K, 5000K, 6500K, 7500K, 9300K; **Default:** 9300K

Aspect Ratio

Adjust the aspect ratio of the screen. The first selection is for the main source, and the second selection is for sources 2-4.

Options: Auto, 16:9, 4:3, Native; **Default:** Auto

Auto Scan

Select whether the display will automatically scan for a Main Input source.
Options: On, Off; **Default:** Off

Select Source

Select the input source.

Options: VGA, HDMI1, HDMI2, DisplayPort

HDMI RGB Range

Select RGB range for HDMI sources.

Options: Auto, Full, Limited; **Default:** Auto

Audio Menu

This menu is used for adjusting audio settings.



Volume

Adjust the sound. Press ◀ or ▶ to select the desired level.

Range: 0~100

Default: 50

Bass

Adjust the sound in low tones (bass). Press ◀ or ▶ to select the desired level.

Range: -6~+6

Default: 0

Treble

Adjust the sound in high tones (treble). Press ◀ or ▶ to select the desired level.

Range: -6~+6

Default: 0

Balance

Adjust the balance of the left and right speakers. Press ◀ or ▶ to select the desired level.

Range: -6~+6

Default: 0

Audio Input

Select the audio source for the Main input.

Options: DisplayPort, HDMI1, HDMI2, Line-In

Internal Speakers

Turn the internal speaker on or off.

Default: On

Basic Menu

This menu is used to make initial setup adjustments to the OSD (On-Screen Display) menu and other on-screen messages.

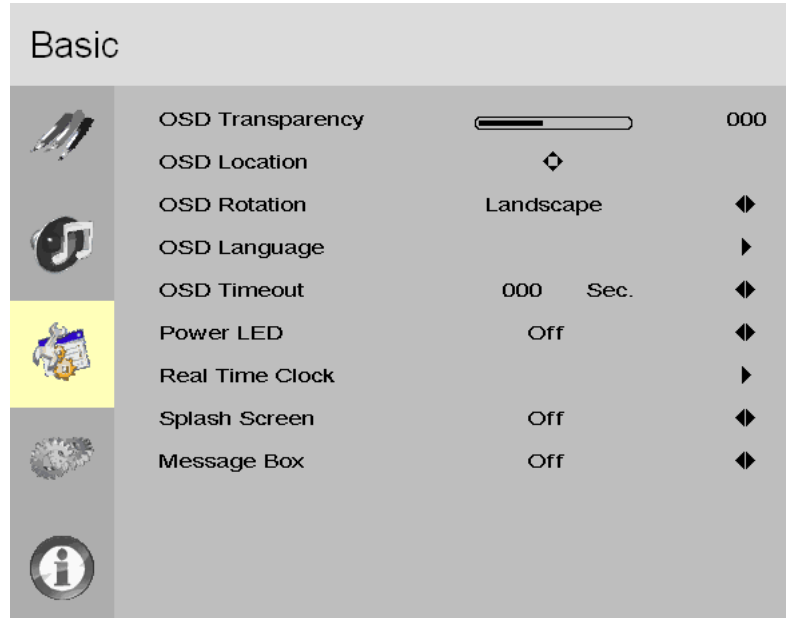

OSD Transparency

Submenu to adjust the transparency of the OSD menu. Press ◀ or ▶ to select the desired level.

Options: 0-12; **Default:** 0

OSD Location

Adjust the horizontal and vertical position of the OSD menu. Press ▲, ▼, ◀ or ▶ to select the desired location.

OSD Rotation

Select the OSD Rotation. Press ◀ ▶ to select the rotation.

Options: Landscape, Portrait; **Default:** Landscape

OSD Language

Select the OSD language.

OSD Timeout

Submenu to adjust the time in seconds before the OSD menu disappears. Press ◀ or ▶ to select the desired level.

Options: 5 sec, 10 sec, 20 sec, 30 sec, 60 sec; **Default:** 30 sec

Power LED

Select whether a splash screen appears when the monitor is powered up.
Options: On, Off; **Default:** On

Real Time Clock

See the “Real Time Clock Submenu” section on page 25.

Splash Screen

Select whether a splash screen appears when the monitor is powered up.
Options: On, Off; **Default:** On

Message Box

Select whether a message box is displayed on screen.
Options: On, Off
Default: On

Real Time Clock Submenu

This menu is used to set the internal clock of the display, and to power on and power off the display at preset times if desired.

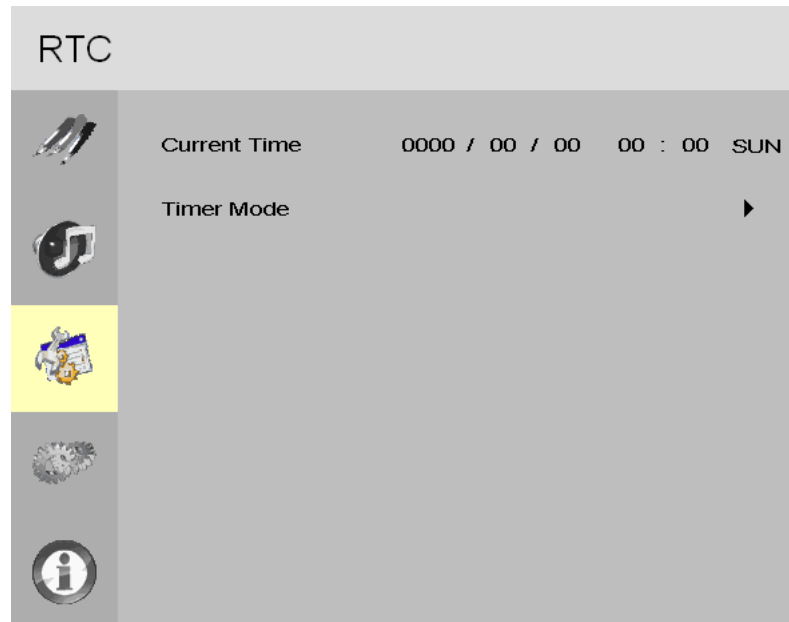

Current Time

Set the year, month, day, and time of day.

Timer Mode

Select how to configure the timer events.

Options: User Mode, Workday Mode, Everyday Mode; **Default:** User Mode

Real Time Clock Submenu – User Mode

Timer Mode		User		
Week	Enable	Power On	Power Off	
MON	<input type="checkbox"/>	00 : 00	00 : 00	
TUE	<input type="checkbox"/>	00 : 00	00 : 00	
WED	<input type="checkbox"/>	00 : 00	00 : 00	
THU	<input type="checkbox"/>	00 : 00	00 : 00	
FRI	<input type="checkbox"/>	00 : 00	00 : 00	
SAT	<input type="checkbox"/>	00 : 00	00 : 00	
SUN	<input type="checkbox"/>	00 : 00	00 : 00	

User Mode

Select the power on/off time for each day of the week.

Options: Disable, Enable

Use the arrow keys to specify the on and off times.

Real Time Clock Submenu – Workday Mode

RTC

Timer Mode	Workday Mode		
	Enable	Power On	Power Off
Week			
MON~FRI	<input type="checkbox"/>	00 : 00	00 : 00
SAT	<input type="checkbox"/>	00 : 00	00 : 00
SUN	<input type="checkbox"/>	00 : 00	00 : 00

Workday Mode

Select the power on/off time for Monday–Friday, Saturday, and Sunday.

Options: Disable, Enable

Use the arrow keys to specify the on and off times.

Real Time Clock Submenu – Everyday Mode

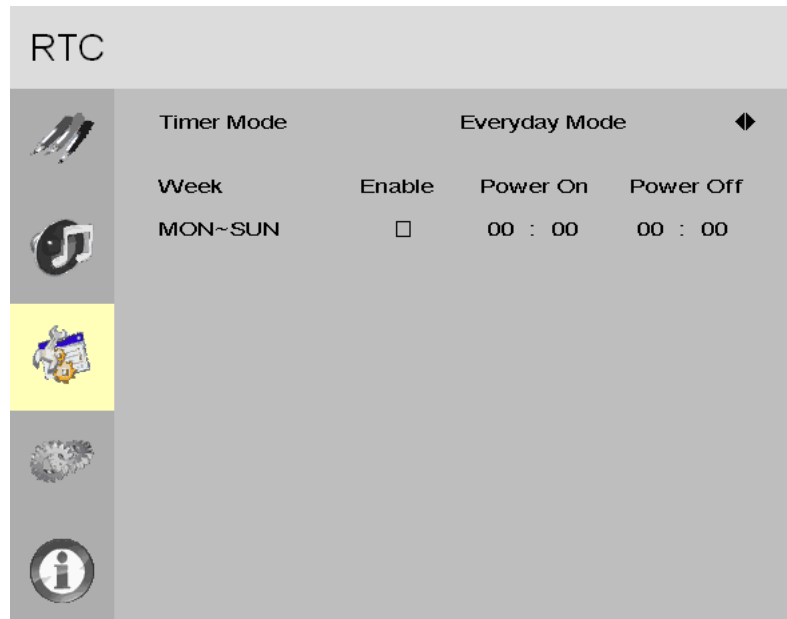

Everyday Mode

Select the power on/off time for all days of the week.

Options: Disable, Enable

Use the arrow keys to specify the on and off times.

Advanced Menu

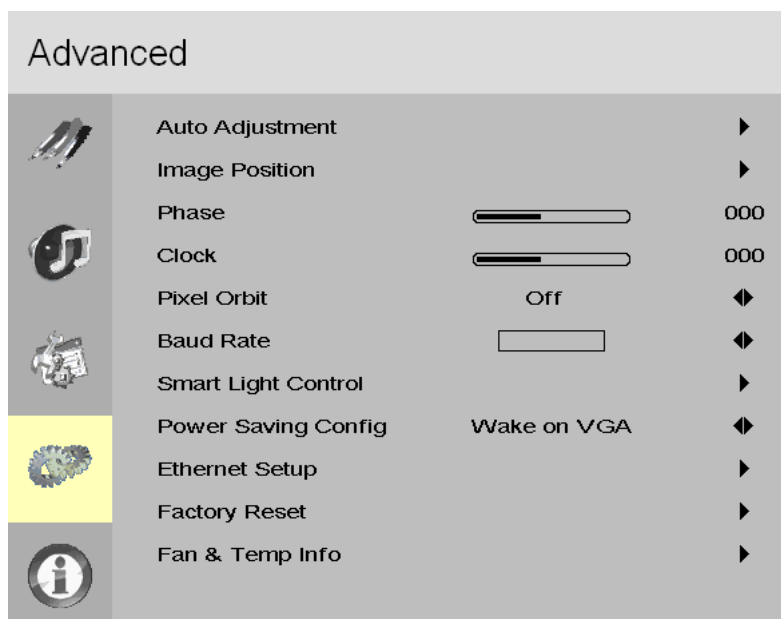

Auto Adjustment

Force the display to reacquire and lock to the input signal (VGA source only). This is useful when the signal quality is marginal. Note: This feature does not continually reacquire the signal.

Options: No, Yes; **Default:** No

Image Position

Adjust the horizontal and vertical position of the image (VGA source only). Press ▲, ▼, ◀ or ▶ to select the desired location.

Phase

Adjust the phase of the displayed signal (VGA source only). Press ◀ or ▶ to select the desired level.

Range: 0~63

Clock

Adjust the clock of the displayed signal (VGA source only). Press ◀ or ▶ to select the desired level.

Range: 0~100

Pixel Orbit

Create slight frame motion to help avoid image retention.

Options: On, Off; **Default:** Off

Baud Rate

Select the baud rate of the display's RS-232 port.
Options: 115200, 38400, 19200, 9600; **Default:** 19200

Smart Light Control

Enable dynamic contrast (DCR) or ambient light sensor.
Options: Off, DCR, Light Sensor; **Default:** Off

Power Saving Config

Options: Wake on VGA, Wake on All, Always On; **Default:** Wake on VGA

Note: For Wake on VGA and Wake on All, the display will enter power saving mode if no signal is received for 5 minutes.

Ethernet Setup

See the "Ethernet Setup" section on page 31.

Factory Reset

Restore all settings to their default.
Options: No, Yes; **Default:** No

Ethernet Setup

This menu configures the display's RS-232 and Ethernet communication ports.

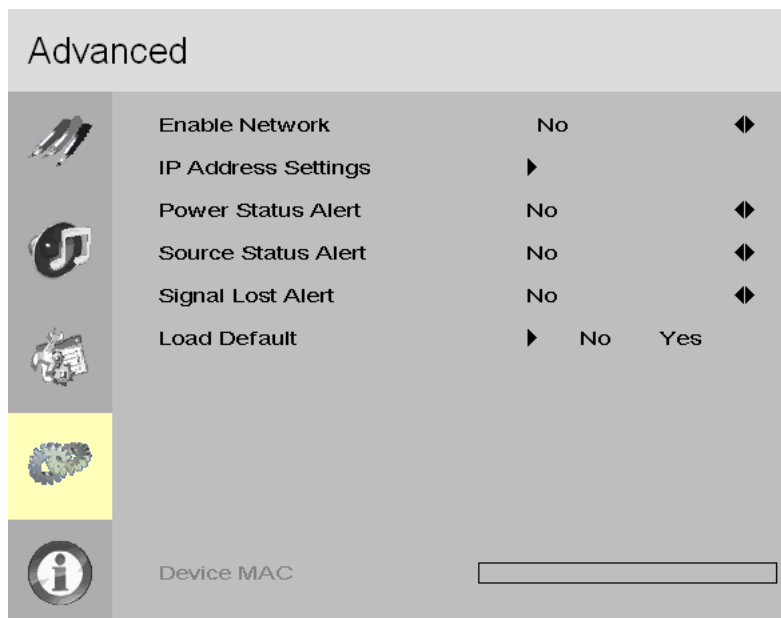

Enable Network

Enable the display's built-in Ethernet port.

Options: No, Yes; **Default:** No

IP Address Settings

Enable Dynamic IP mode or set the static IP address of the display's Ethernet port.

Power Status Alert

Enable an automatic alert when the display is powered down.

Options: No, Yes; **Default:** No

Source Status Alert

Enable an automatic alert when the source is changed.

Options: No, Yes; **Default:** No

Signal Lost Alert

Enable an automatic alert when the video signal is lost.

Options: No, Yes; **Default:** No

Load Default

Load default communication settings.

Options: No, Yes; **Default:** No

Device MAC

Shows the MAC address of the display.

Assigning an IP Address to the Display

To assign an IP address to your display, access the IP Address Settings Menu in the **Communication** menu. Consult your system administrator if you do not know how to configure the parameters shown in the menu.

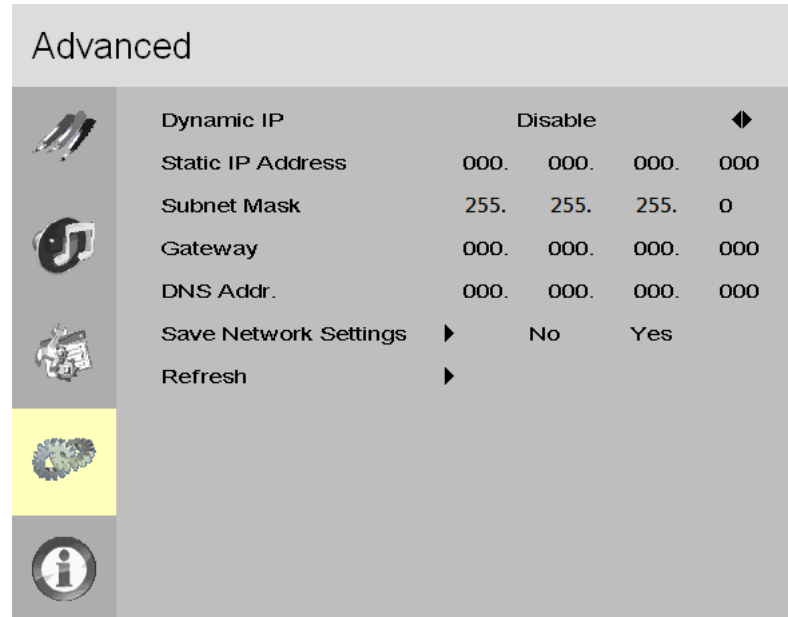





The default settings are shown below.

Item	Setting
Dynamic IP	Disable
Static IP Address	192.168.2.1
Subnet Mask	255.255.255.0
Gateway	192.168.2.1
DNS Addr.	192.168.2.1

System Menu

This read-only menu provides information on the active sources and the latest firmware version.

System

	Channel Information	
	Source	DisplayPort
	Resolution	1920x1080@60
	Firmware Version :	PS4662T V1.00 SubMCU-V13
	SN:	111111111111

Using the Touch Screen

You can use the touch screen to control your Windows, Mac or Linux operating system. The Planar PS Series is HID compliant, delivering up to 10 points of touch on both Windows and Linux without a driver. Single touch only is supported for Mac operating systems. To achieve more than single touch Mac support, drivers will need to be installed, which can be found on <http://www.planar.com/support>.

Note: Ensure that you have installed the USB cable on the display to a computer.

LAN Control

The Planar PS Series supports extending access to the RS232 commands over a network connection using a virtual COM port (VCOM). The VCOM driver can be found on <http://www.planar.com/support>.

Note: RS232 commands over LAN can be achieved by opening a TCP connection to Port 23 to the display. The LAN control functionality is most frequently used by control systems, and they won't be able to use the VCOM drivers

Supported Operating Systems

The utility supports the following operating systems:

- Windows 7
- Windows 8 and 8.1
- Windows 10

Installation

Use the following instructions to install the VCOM driver.

- 1 Launch the vcomsetup.exe file.
- 2 You may see a security warning similar to the following example. Click Run to continue.

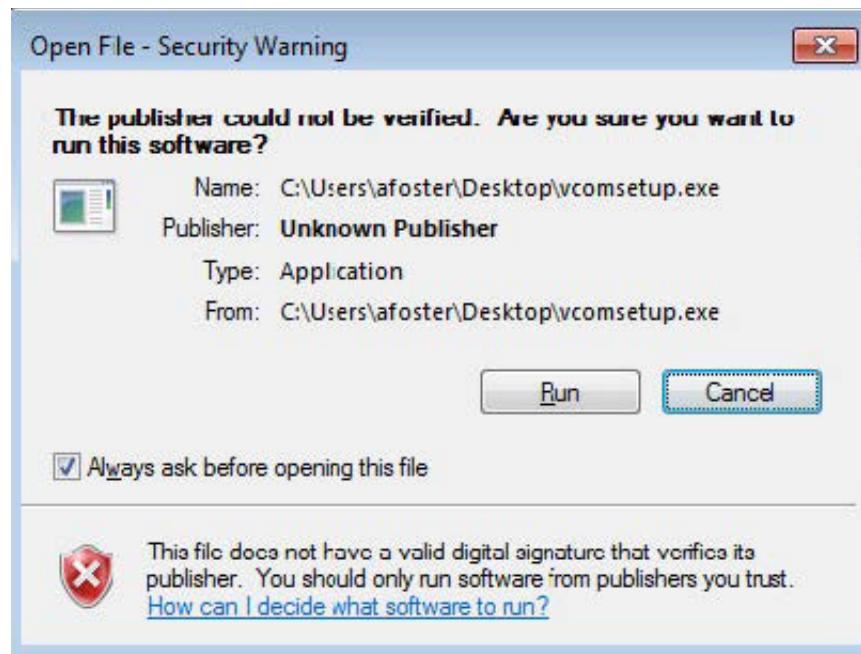

- 3 The vcomsetup.exe installer installs both the VCOM virtual serial port and also a utility (WinPcap) for finding your displays on the network. Follow the steps in the two installers, accepting defaults and license agreements as needed.

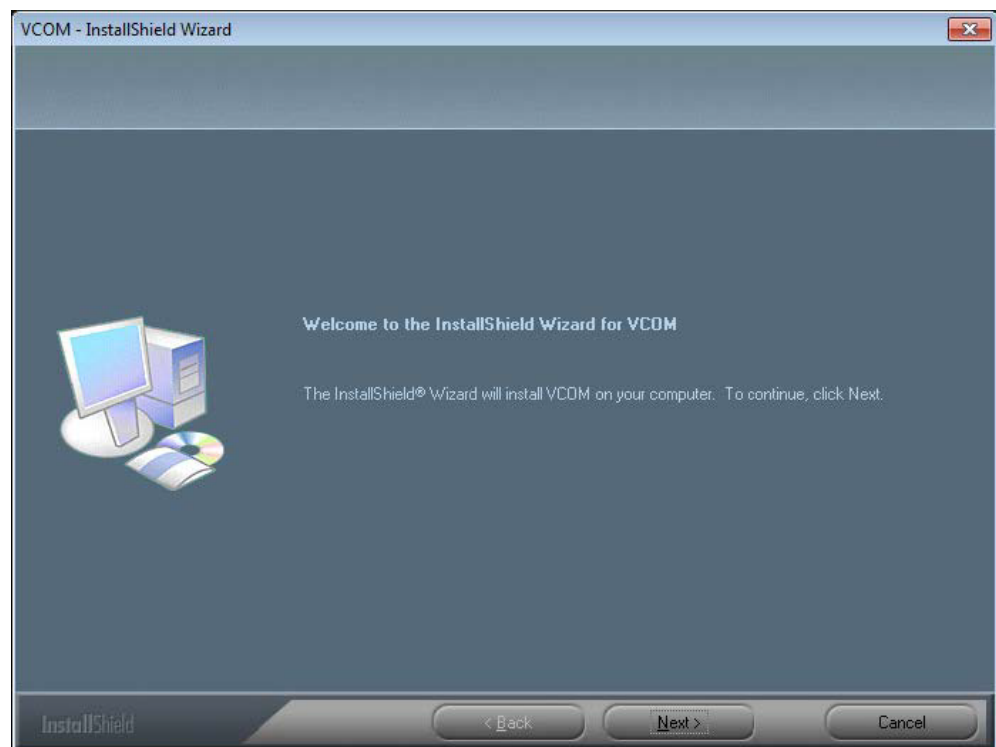
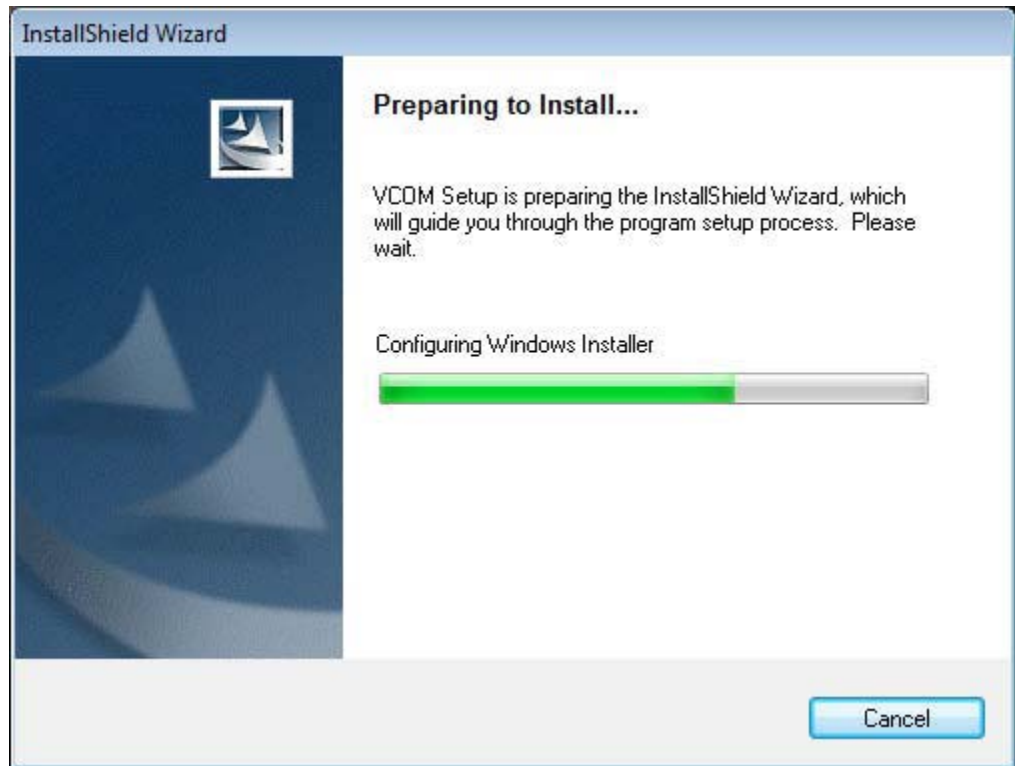

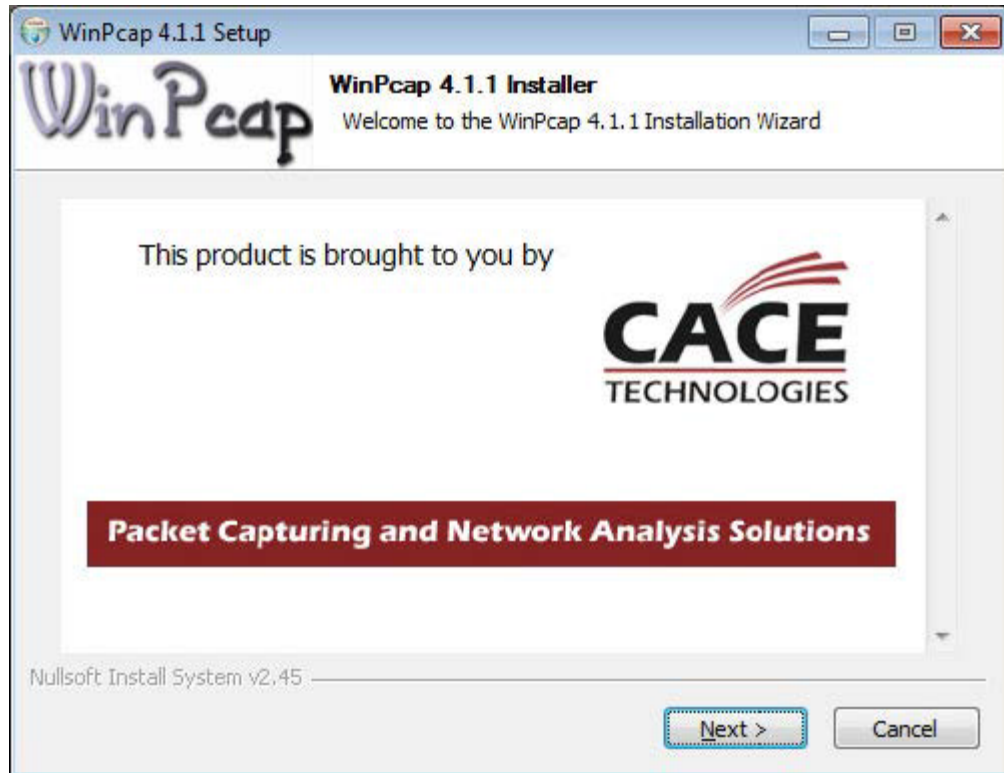

- 4 When the installers are finished, you will see a VCOM icon on your desktop and you find two new folders in your start menu: IC Plus corp (with VCOM sub folder) and WinPcap. If you need to uninstall the software, there are shortcuts to uninstall from these menus.



Configuring VCOM

Use the VCOM shortcut to launch the VCOM setup utility. The utility starts up on the Device Info page, shown below. The controls on this page allow you to find and configure each display that you want to access via virtual COM ports.

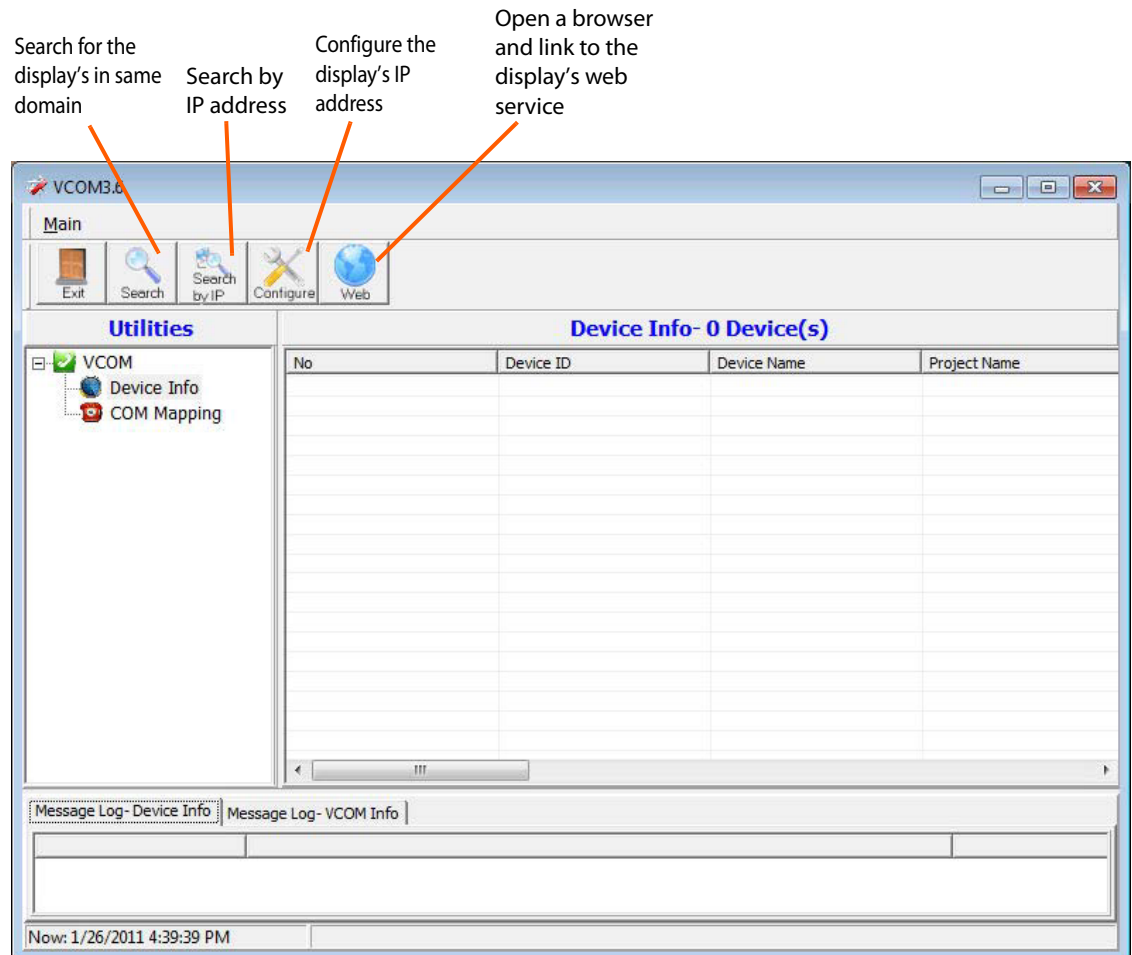

Click on COM Mapping to display the COM Mapping page, shown below. The controls on this page allow you to make virtual COM ports and select the display to which you want to map each virtual COM port.

Create a virtual COM port Remove an existing virtual COM port

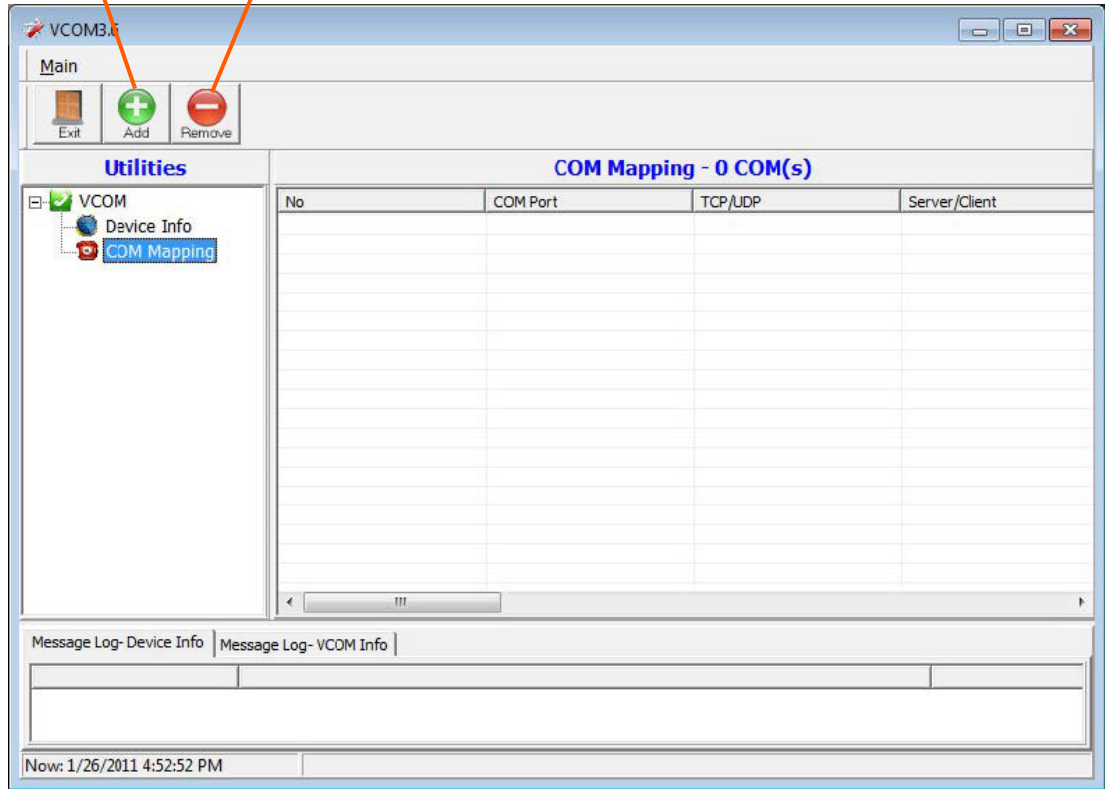

Function Descriptions

Search

In the Device Info page, click the Search icon. This function searches for any devices that are connected to the same network segment (maximum of 254 devices) as your PC. Any devices found will be listed in the Device Info table.

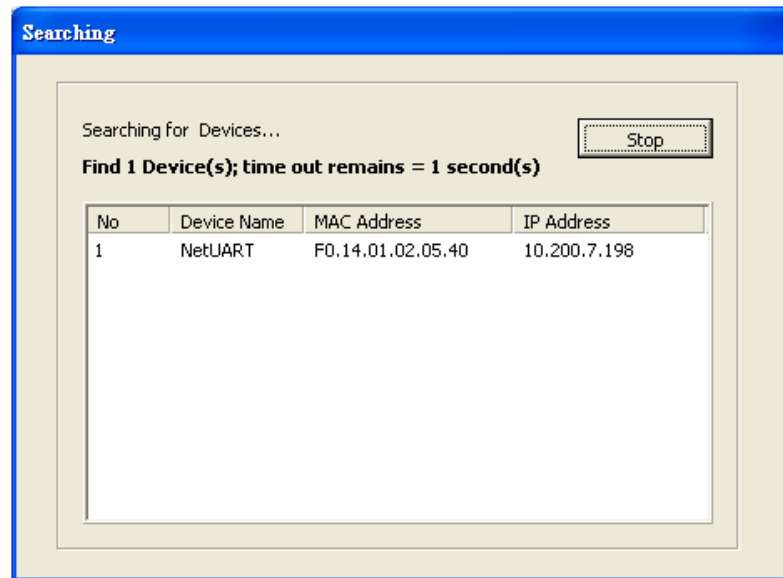

Search By IP

On the Device Info page, click the Search by IP icon. This function searches for any devices in the given IP address range. Any devices found will be listed in the Device Info table.

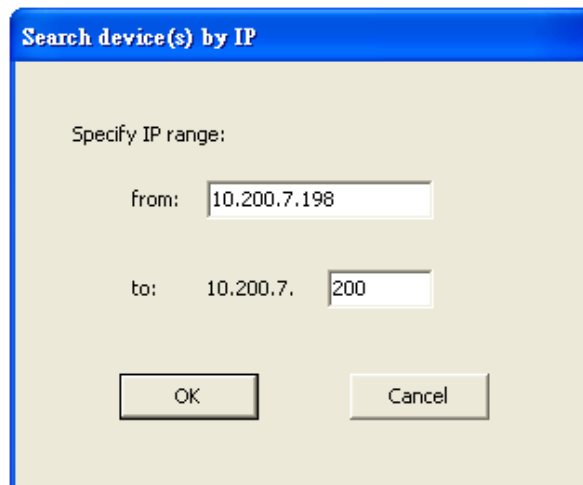

Configure IP Address

This function allows you to configure the network settings of the selected device. We recommend using the on-screen menus or the web interface described in the User Guide instead of this function.

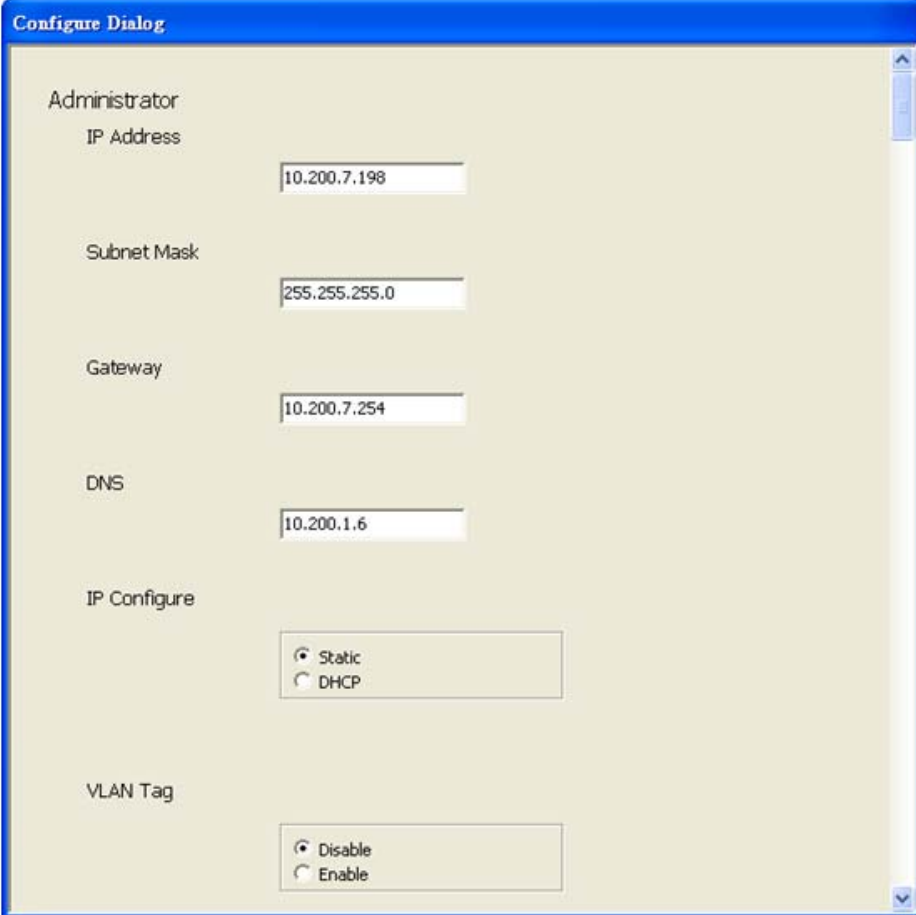

The screenshot shows a 'Configure Dialog' window with the following fields and options:

- Administrator
- IP Address: 10.200.7.198
- Subnet Mask: 255.255.255.0
- Gateway: 10.200.7.254
- DNS: 10.200.1.6
- IP Configure: Static, DHCP
- VLAN Tag: Disable, Enable

Note: To cancel this function, scroll to the bottom and click the Cancel button.

Web

Click the Web icon to launch your default browser and link it to the display's web service.

Adding a Virtual COM Port

To add a virtual COM port, click the Add icon on the COM Mapping page to open the following dialog window.

The 'Add VCOM' dialog window contains the following elements:

- Rescan** button
- Table:**

No	Device Name	MAC Address	IP Address
1	NetUART	F0.14.01.02.05.40	10.200.7.198
- TCP/UDP:** TCP, UDP
- Server/Client:** Server, Client
- IP Address:** 10.200.7.198
- Local Port:** [Empty]
- COM:** 22
- Remote Port:** 23
- Enable Control Connection
- 1 second(s) for reconnection interval.
- OK** and **Cancel** buttons

Select the display you want to control from the table and accept defaults, as shown. Make a note of the COM number assigned to the new VCOM port. Click OK to create the new port. The new port appears in the COM Mapping table.

You can view details for the virtual COM port device using Device Manager, shown below.

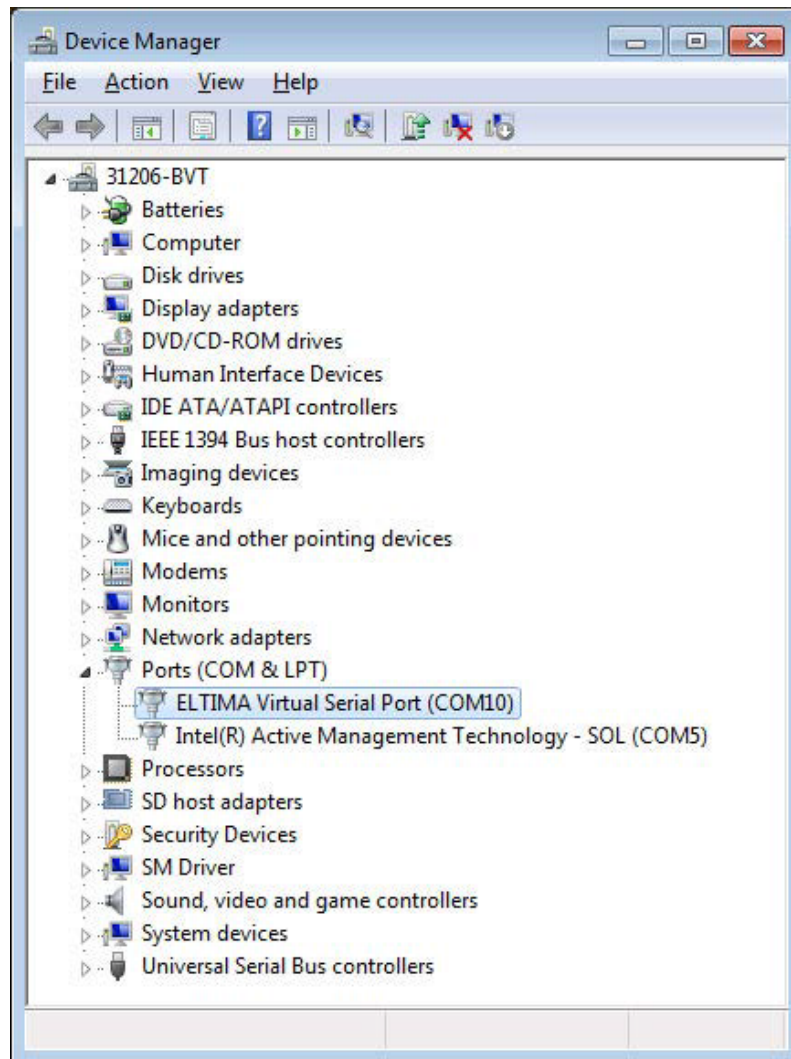

Removing a COM Port

On the COM Mapping page, select the COM port you want to delete and click the REMOVE button.

Setting Up Email Alerts

The web service allows you to configure the settings required to send email alerts. If you are not using email alerts, you do not need to use the web service and can skip this section.

Login

When you direct your browser to the network IP address of the display, you are prompted to login as shown here.

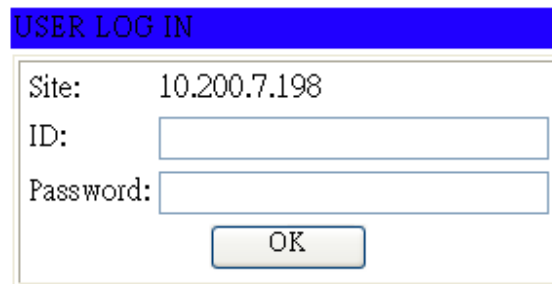

USER LOG IN

Site: 10.200.7.198

ID:

Password:

OK

The default ID is **admin** and the default password is **system**.

Note: Cookies and JavaScript must be enabled in your browser.

Note: If your session times out or if you enter an incorrect ID or password, you will see the following message.



When you first login, you will see the System Status page, as shown here.

PLANAR
When image experience matters.

Administrator
TCP Mode
UDP Mode
UART
SMTP
Reset Device

System Status

Kernel Version	V2018 (Dec 08 2010 10:08:13)	
MAC Address	00:1F:B6:00:00:22	
Nickname	<input type="text" value="NetUART"/>	<input type="button" value="Update"/>

Please refresh web page after press "updated" button.

Note:
Comment name only can use "0-9", "a-z", "A-Z", "_", "-"

Administrator

Click on the word Administrator under the Planar logo to show/hide these menu items.

Authentication Configuration

Set user ID and password for login to the web service.

PLANAR
When image experience matters.

Administrator

- [Authentication Configuration](#)
- [System IP Configuration](#)
- [System Status](#)
- [Load default setting](#)
- [Firmware update](#)
- [Boot Loader upgrade](#)
- [TCP Mode](#)
- [UDP Mode](#)
- [UART](#)
- [SMTP](#)
- [Reset Device](#)

Authentication Configuration

Setting	Value
Username	admin max:15
Password Confirm max:15

Please refresh web page after press "updated" button.

Note:
Comment name only can use "0-9", "a-z", "A-Z"

System IP Configuration

You can view and/or change the network settings here. However, for best results, we recommend that you use the on-screen display menus.

PLANAR
When image experience matters.

Administrator

- [Authentication Configuration](#)
- [System IP Configuration](#)
- [System Status](#)
- [Load default setting](#)
- [Firmware update](#)
- [Boot Loader upgrade](#)
- [TCP Mode](#)
- [UDP Mode](#)
- [UART](#)
- [SMTP](#)
- [Reset Device](#)

System IP Configuration

Setting	Value
IP Address	192 . 168 . 2 . 1
Subnet Mask	255 . 255 . 255 . 0
Gateway	192 . 168 . 2 . 1
DNS	192 . 168 . 2 . 1
IP Configure	<input type="radio"/> Static <input checked="" type="radio"/> DHCP
VLAN Tag	<input checked="" type="radio"/> Disable <input type="radio"/> Enable : VLAN ID 0

Please refresh web page after press "updated" button.

If your network requires a VLAN tag, your network administrator will give you a number from 1 to 4094 to enter here.

System Status

- Kernel version - Shows the firmware version for the network interface.
- MAC Address - Shows the unique address assigned to the network interface.
- Nickname - Enter a device tag, up to 12 characters. This tag will appear in email alerts, which help you identify the source of the alert.

PLANAR
When image experience matters.

Administrator

- [Authentication Configuration](#)
- [System IP Configuration](#)
- [System Status](#)**
- [Load default setting](#)
- [Firmware update](#)
- [Boot Loader upgrade](#)
- [TCP Mode](#)
- [UDP Mode](#)
- [UART](#)
- [SMTP](#)
- [Reset Device](#)

System Status

Kernel Version	V2018 (Dec 08 2010 10:08:13)	
MAC Address	00:1F:B6:00:00:22	
Nickname	NetUART <input type="text"/>	<input type="button" value="Update"/>
Please refresh web page after press "updated" button.		

Note:
Comment name only can use "0-9", "a-z", "A-Z", "_", "-"

Load Default Setting

- 1 Click the LOAD button to return the network interface to default settings.

Load Default Setting to EEPROM

- 2 After a few seconds, you will see a green box with the message "Setting Saved RESET." Click the RESET button to restart the network interface.

Setting Saved
RESET

- 3 Make sure the IP address in your browser is correct and then click OK.



- 4 When the process is complete, you should see the login page again.

Firmware Update and Boot Loader Upgrade

In most cases, you will not need to update firmware for the network interface. If you do, contact Planar's Technical Support Department. See "Accessing Planar's Technical Support Website" on page 62 for more information.

WARNING! Do not use the controls in these two sections unless you have received a specific procedure and firmware from Planar. Following improper procedures can disable the network interface and require factory repair service.

TCP Mode, UDP Mode and UART

For normal operation, you will not need to change any settings on these pages. If you do need to change information, Planar's Technical Support Department will provide you with more information.

SMTP

SMTP setup

Enable SMTP	<input type="checkbox"/> Enable, Port: <input type="text" value="25"/>
SMTP server address	<input type="text" value="smtp.xxx.yyy"/>
SMTP Login Information	<input type="checkbox"/> Enable Username: <input type="text" value="username"/> , Password: <input type="password" value="••••••"/>
Mail to	<input type="text" value="xxx@yyy.zzz"/> max: 200
Mail from	<input type="text" value="xxx@yyy.zzz"/>

Your network administrator must provide information for the following fields:

- Enable SMTP - Make sure this checkbox is checked. Port 25 is the default.
- SMTP Server Address - Name or IP address of the mail server.
- SMTP Login Information - If required, check the ENABLE box and enter a username and password.
- Mail to - Enter the destination email addresses. Separate multiple addresses with a semi-colon.
- Mail from - Enter the email address from which you want to send alerts.

SMTP 01 Warning	
Subject	Power Status Change Alert
Message Body	SMTP 01 bcdy max: 100

SMTP 02 Warning	
Subject	Source Change Alert
Message Body	SMTP 02 bcdy max: 100

SMTP 03 Warning	
Subject	Signal Lost Alert
Message Body	SMTP 03 bcdy max: 100

You can edit the subject and body of the email warnings, which are sent when there is a power status change, source change and signal lost. The SMTP 04 and 05 warnings are not used.

Reset Device

Click the RESET button to reboot the network interface. Note that the current settings are not changed.

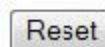

Signal Compatibility

Signal Type	Resolution	Frame Rate (Hz)	Line Rate (kHz)	Pixel Rate (MHz)	HDMI	DisplayPort	VGA	References
PC	640x480	59.940	31.469	25.175	x	x	x	VESA DMT, CEA-861-F Format 1
	800x600	60.317	37.879	40.000	x	x	x	VESA DMT
	848x480	59.659	29.830	31.500	x	x	x	VESA CVT
	1024x768	60.004	48.363	65.000	x	x	x	VESA DMT
	1280x768	49.929	39.593	65.250	x	x	x	VESA CVT
	1280x768	59.995	47.396	68.250	x	x	x	VESA CVT-R
	1280x768	59.870	47.776	79.500	x	x	x	VESA CVT
	1280x800	59.910	49.306	71.000	x	x	x	VESA DMT
	1280x800	59.810	49.702	83.500	x	x	x	VESA CVT
	1280x960	60.000	60.000	108.000	x	x	x	VESA DMT
	1280x1024	60.020	63.981	108.000	x	x	x	VESA DMT
	1366x768	59.799	47.720	84.750	x	x	x	VESA CVT
	1400x1050	49.965	54.113	100.000	x	x	x	VESA CVT
	1400x1050	59.948	64.744	101.000	x	x	x	VESA CVT-R
	1400x1050	59.978	65.317	121.750	x	x	x	VESA CVT
	1440x900	59.901	55.469	88.750	x	x	x	VESA DMT
	1440x900	59.887	55.935	106.500	x	x	x	VESA CVT
	1600x1200	60.000	75.000	162.000	x	x	x	VESA DMT
	1920x1080	49.929	55.621	141.500	x	x	x	VESA CVT
	1920x1080	59.934	66.587	138.500	x	x	x	VESA CVT-R
1920x1200	59.950	74.038	154.000	x	x	x	VESA CVT-R	
1680x1050	49.974	54.121	119.500	x	x	x	VESA CVT	
1680x1050	59.954	65.290	146.250	x	x	x	VESA CVT	
EDTV	480p	60	31.469	27.000	x	x		ITU-R BT.1358, CEA-861-F Format 17 & 18
	576p	50	31.250	27.000	x	x		SMPTE 125M, CEA-861-F Format 6 & 7

Signal Type	Resolution	Frame Rate (Hz)	Line Rate (kHz)	Pixel Rate (MHz)	HDMI	DisplayPort	VGA	References
HDTV	1080i	50	28.125	74.500	x	x		SMPTE 274M, CEA-861-F Format 20
	1080i	60	33.750	74.250	x	x		SMPTE 274M, CEA-861-F Format 5
	720p	50	37.500	74.250	x	x		SMPTE 296M, CEA-861-F Format 19
	720p	60	45.000	74.250	x	x		SMPTE 296M, CEA-861-F Format 4
	1080p	50	56.250	148.500	x	x		SMPTE 274M, CEA-861-F Format 31
	1080p	60	67.500	148.500	x	x		SMPTE 274M, CEA-861-F Format 16

Specifications

Item	PS4662T	PS5562 PS5562T	PS6562
LCD Panel			
Resolution	1920x1080		
Aspect Ratio	16:9		
Screen Size	46"	55"	65"
Orientation	Landscape/Portrait		
Brightness (Typ.)	500 cd/m ²		
Contrast Ratio	4000:1		
Viewing Angle (Typ.)	178°		
Response Time (Typ.)	6.5ms		8ms
Color Gamut	72% NTSC		
Display Color	1.07 billion (10-bit depth)		
Connectivity			
Standard Inputs	DisplayPort 1.1, HDMI 1.4b x 2, VGA		
Audio Output	Line out		
Control and Monitoring	LAN RJ45, RS232 In, IR, Keypad		
Mechanical			
Display Dimensions	42.1" x 24.4" x 2.87" (1068.9mm x 620.5mm x 73mm)	Standard: 49.3" x 28.5" x 2.26" (1252mm x 722.8mm x 57.4mm) Touch: 49.6" x 28.6" x 2.91" (1259.2mm x 725.2mm x 73.9mm)	57.6" x 33" x 2.35" (1464.2mm x 839.2mm x 59.7mm)
Bezel Width	0.85" (21.7mm)	Standard: 0.71" (18mm) Touch: 0.79" (20.1mm)	0.67" (16.9mm)
Display Weight	64 lbs (29 kg)	Standard: 68 lbs (31 kg) Touch: 86 lbs (39 kg)	83 lbs (38 kg)
Mounting	VESA 400 mm x 400 mm		
Fanless	Yes		
Speakers	10W x 2 built-in		

Item	PS4662T	PS5562 PS5562T	PS6562
Usage			
Recommended Usage	24x7		
Backlight	E-LED		D-LED
Backlight Life	30,000 hours min		
Power Source			
Power Consumption (Typ.)	81W	108W	165W
BTU/hr (Typ.)	81W x 3.42 BTU = 277 BTU/hr	108W x 3.42 BTU = 369 BTU/hr	165W x 3.42 BTU = 564 BTU/hr
Standby Power Consumption	< 0.5W		
Input Voltage / Frequency	AC 100-240V 50-60 Hz		
Environment			
Storage Temperature	Min -4°F ~ Max 140°F (-20°C ~ 60°C)		
Operating Temperature	Min 32°F ~ Max 104°F (0-40°C) at up to 3000 m		
Humidity	20-85% RH		
Approvals	FCC Class A, cTUVus, CE		

Dimensions

PS4662T

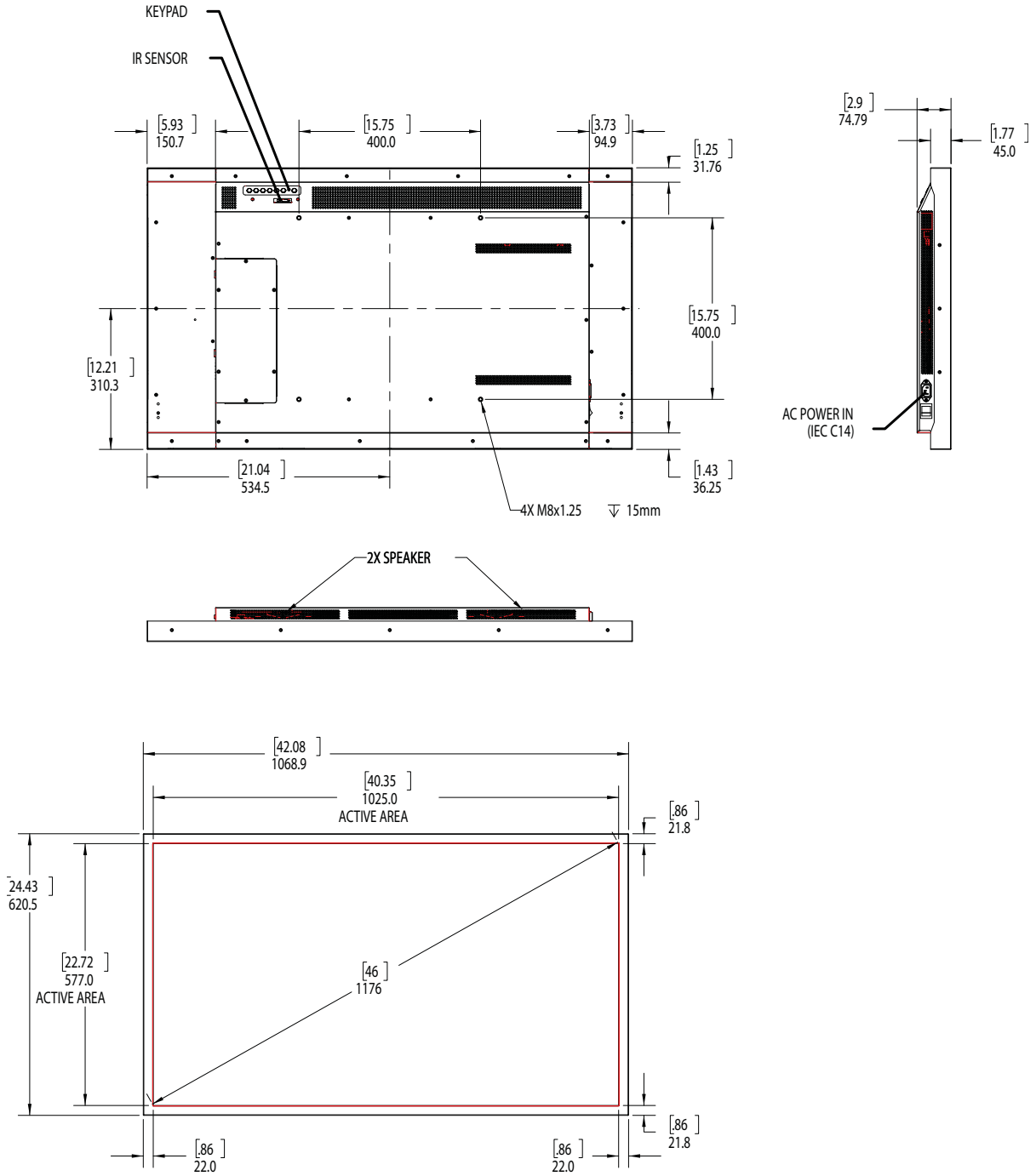

PS5562

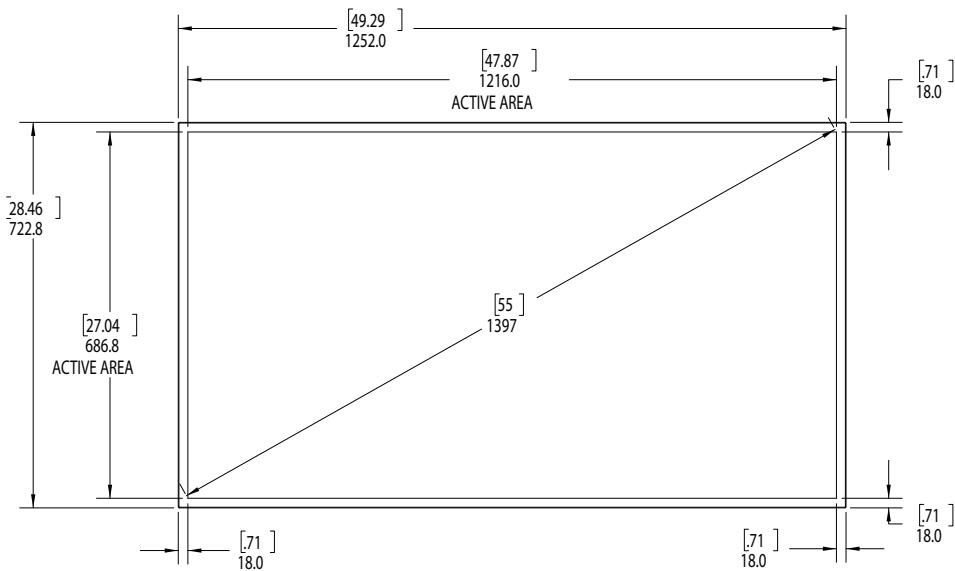
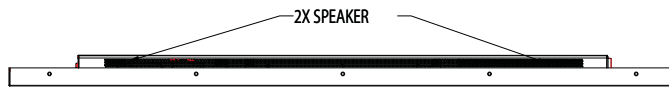
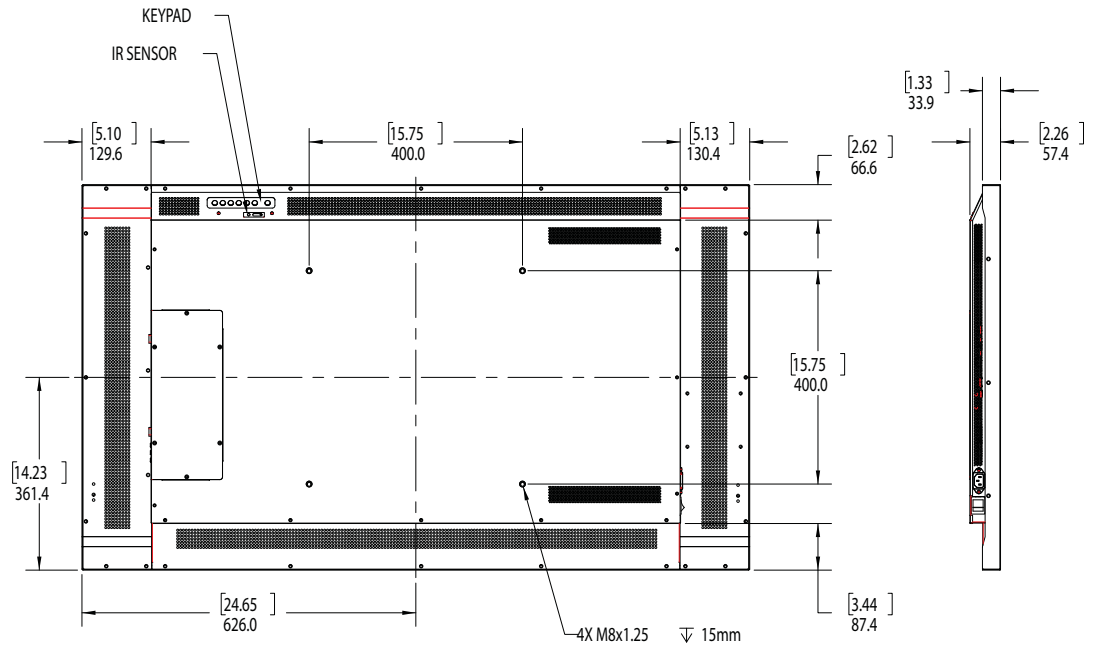

PS5562T

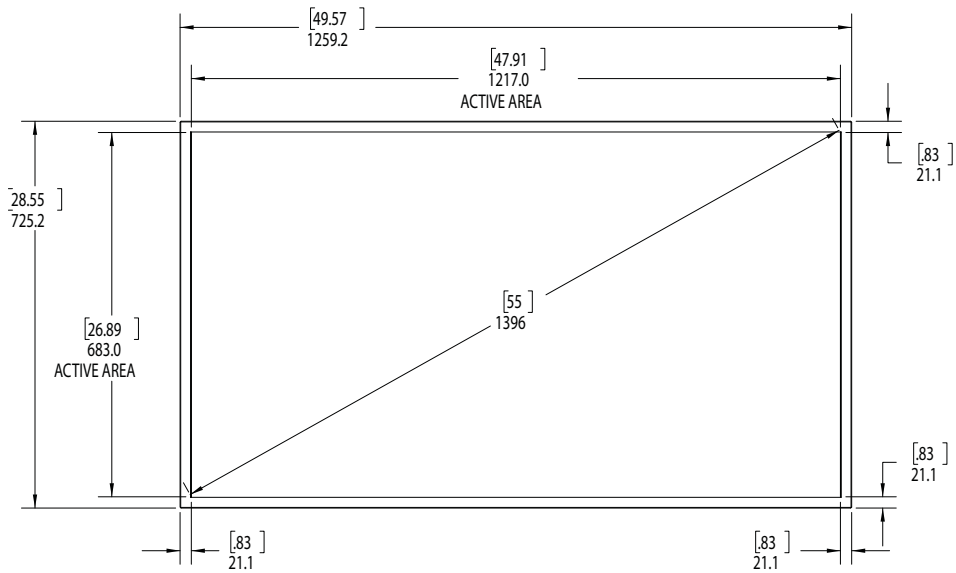
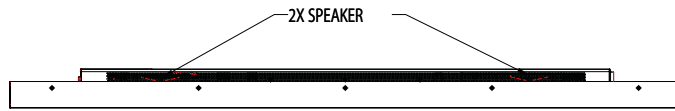
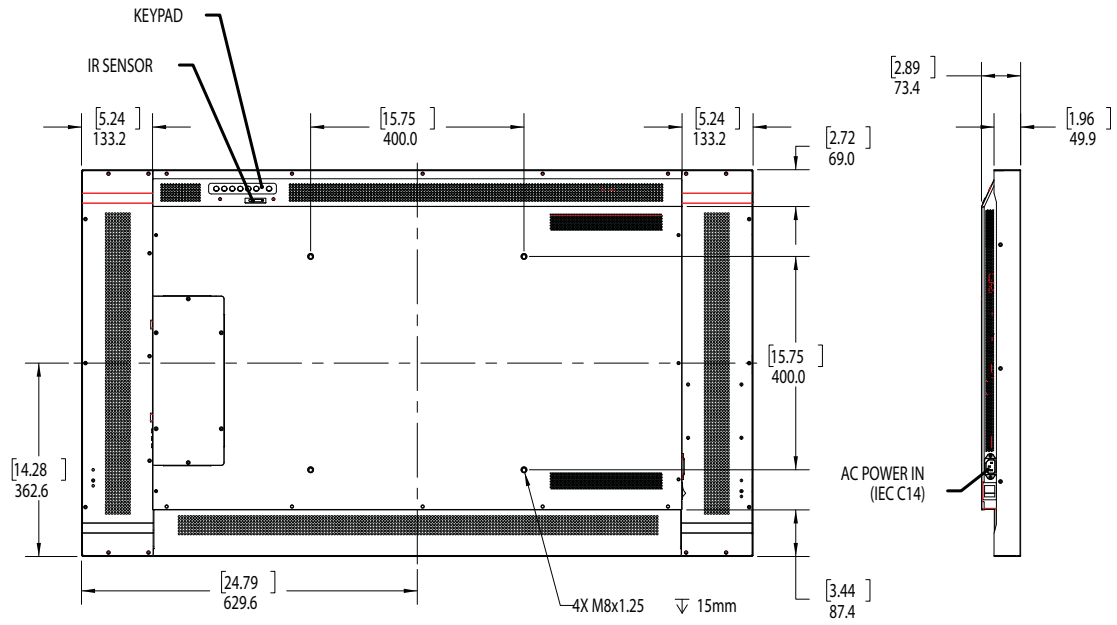

PS6562

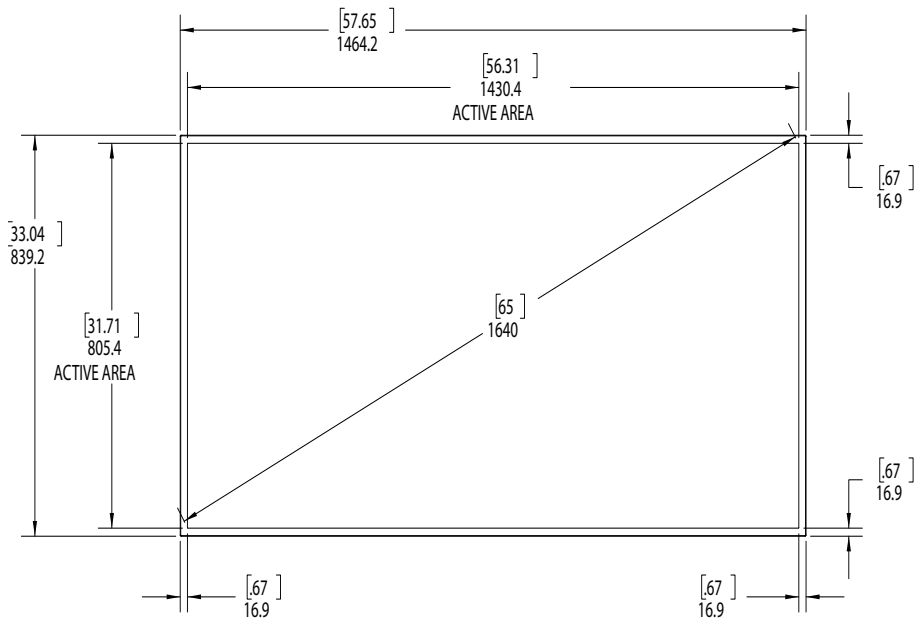
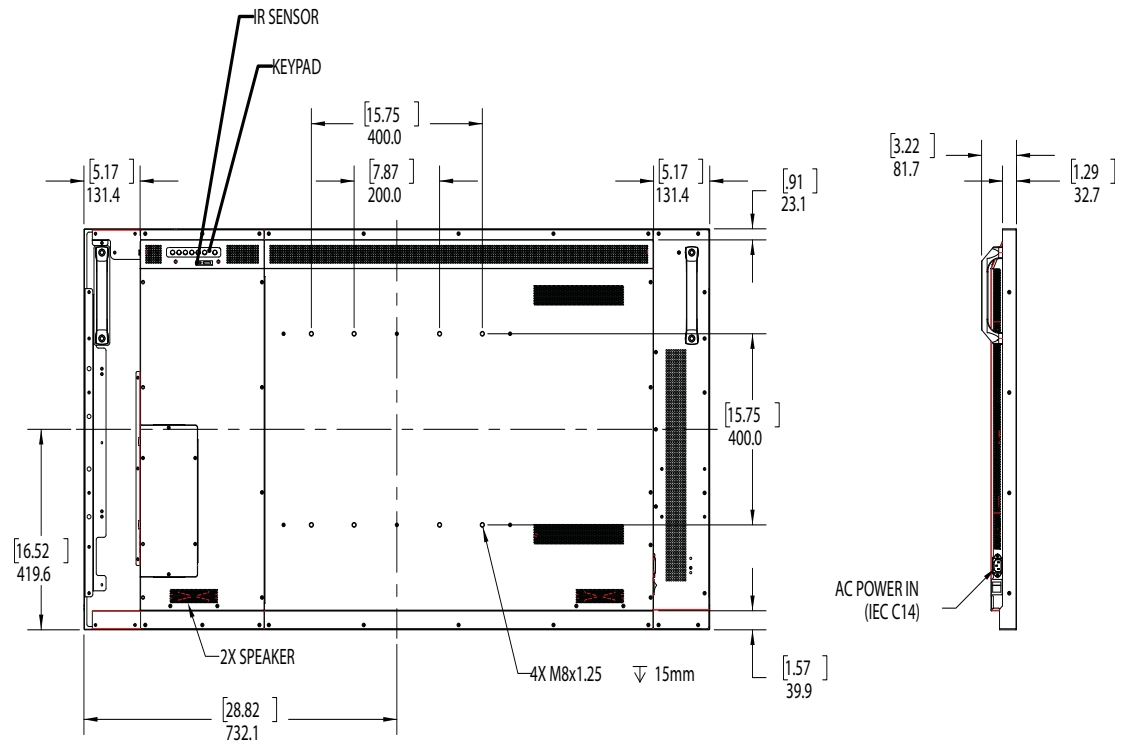

Troubleshooting

Symptoms, Possible Causes and Solutions

Below are different symptoms that you might encounter as you install your Planar PS Series display. First look at the different symptoms to see if you can find your issue. And then look at the possible cause and try the suggested solution(s). If you still are not able to resolve your issue, please contact Planar's Technical Support Department.

Symptom: No Image Is Displayed

Solution

Make sure the correct source is selected.

Solution

Make sure the main power switch is turned ON.

Solution

Check that the source equipment is operating correctly.

Solution

Make sure the input signal is compatible with this display.

Symptom: The Image Is Not Centered

Solution

Make sure the input signal is compatible with this display.

Symptom: The Remote Control Doesn't Work

Solution

Make sure the batteries are new and are installed correctly.

Solution

Make sure the remote control sensor is plugged in correctly.

Solution

Make sure the remote is aimed towards the back of the display, where the sensor is located.

Symptom: The Picture Color Looks Poor

Solution

Check the picture settings.

Reset the display.

Accessing Planar's Technical Support Website

Go to <http://www.planar.com/support> to locate the following support documents and resources:

- User Guide
- RS232 User Manual
- Touchscreen drivers
- Standard warranties
- Planar support hotline number and email

Index

A

adjusting volume, 18
administrator in web service, 47
audio settings menu, 19
authentication configuration page, 47
avoiding temporary image retention, 4

B

basic settings menu, 19
batteries
 changing in the remote, 17

C

cleaning the display, 7
connecting
 touch screen, 34
cooling requirements, 6

D

default setting
 loading in web service, 48
display settings menu, 19

E

exemptions for product use, 8

I

image settings menu, 19
input source
 selecting, 18
installation, 11
 safety precautions, 3
introduction, 1
ip system configuration, 47

L

LAN control, 35
locking, 17

M

menus
 audio settings, 19
 basic settings, 19
 display settings, 19
 image settings menu, 19
 using, 19

N

navigating, 19
navigating menus, 19
network interface
 resetting, 51
normal usage guidelines, 6

O

osd menus, 17, 19
unlocking, 17

P

package contents, 8
product usage
 exemptions, 8

R

recommended usage, 4
remote control
 changing the batteries, 17
 using, 15
resetting the network interface, 51

RS232 network connection, 35

S

safety

- during installation, 3
- information, 2
- precautions, 2
- precautions during use, 4

selecting input source, 18

service plans, ii

signal compatibility, 52

SMTP setup page, 50

specifications, 54

supported timings, 52

system ip configuration page, 47

system status page, 46, 48

T

temporary image retention

- avoiding, 4
- definition, 4

timings, 52

TIR *see temporary image retention*

touchscreen

- using the touchscreen, 34

troubleshooting, 54

turning off the displays, 18

turning on the displays, 18

U

using the remote, 15

V

VCOM

- configuration, 39
- driver installation, 36

vesa mounts, 6

volume, 18

W

warranty

exemptions, 8

information, ii

web service, 45

- administrator, 47
- authentication configuration, 47
- loading default setting, 48
- reset device, 51
- SMTP setup page, 50
- system ip configuration, 47
- system status, 46
- system status page, 48