

Planar LookThru L055 User Manual



Copyright © 2016 by Planar Systems, Inc. All rights reserved.

The contents of this publication may not be reproduced in any form without permission of Planar Systems, Inc.

Trademark Credits

Planar® LookThru™ is a trademark of Planar Systems, Inc.

Windows™ is a trademark of Microsoft Corp.

All other names are trademarks or registered trademarks of their respective companies.

Disclaimer

The information contained in this document is subject to change without notice. Planar Systems, Inc. makes no warranty of any kind with regard to this material. While every precaution has been taken in the preparation of this manual, the Company shall not be liable for errors or omissions contained herein or for incidental or consequential damages in connection with the furnishing, performance, or use of this material.

Warranty and Service Plans

Planar warranty and service plans will help you maximize your investment by providing great support, display uptime, and performance optimization. From post-sale technical support to a full suite of depot services, our services are performed by trained Planar employees. When you purchase a Planar product, you get more than a display, you get the service and support you need to maximize your investment. To find the latest warranty and service information regarding your Planar product, please visit <http://www.planar.com/support/>

RoHS Compliance Statement

The Planar LookThru LO55 series is fully RoHS compliant.

Part Number: 020-1302-00

Contents

- Introduction5**
- Safety Information6**
 - Safety Precautions 6
 - Important Safety Instructions..... 7
- Recommended Usage8**
 - European Disposal Information9
- Tour of the Planar LookThru Transparent OLED Product Family 10**
 - Display Architecture.....10
 - Additional Components Shipped with Every Display 15
- Unpacking and Installing the Display..... 19**
 - Safe Handling.....19
 - Environmental Considerations.....20
 - Installation Disclaimer.....20
 - Requirements for All Installations.....20
 - Multiple Displays.....22
 - Multi-Display, User-Provided Touch22
- Operating the Display..... 23**
 - OSD Keypad.....23
 - OSD Keypad Buttons24
 - Using the Remote Control.....24
- IR Command Protocol..... 26**
 - Locking the Keypad and IR Remote.....28
 - Unlocking the Keypad and IR Remote.....28

Turning the Display On.....	29
Turning the Display Off.....	29
LED Indicators	29
Navigating Through the Menus	30
Inputs and Views Menu.....	31
Image Adjust Menu	33
Audio Menu	37
Presets Menu	38
Advanced Settings Menu.....	39
Tiling.....	48
Information Menu.....	52
Using the Touch Screen (Planar LookThru LO55-T and LO55-ST Models)	54
Developing Content.....	54
Signal Compatibility	55
Troubleshooting	59
Maintenance.....	60
Cleaning the Display	60
Specifications	61
Line Drawings.....	63
Standard Design.....	63
Straightmount Design	64
Standard Design with Touch.....	65
Straightmount Design with Touch.....	66
Accessing Planar’s Technical Support Website.....	67
Regulatory Information.....	68

Introduction

The Planar® LookThru™ OLED transparent display showcases dynamic or interactive information on a transparent surface glass. This display allows users to view what is shown on a glass video screen while still being able to see through it. Designers can overlay text, digital images, and video content onto physical objects or scenes that sit behind the glass.

Truly See-Through Installations

The first-of-its-kind Planar LookThru OLED transparent display is a self-emitting display that utilizes Organic Light Emitting Diode (OLED) to eliminate the need for a backlight or enclosure, making it possible to create truly see-through installations. The design offers virtually frameless glass with 45 percent light transmissivity, creating clear, unobstructed views of objects, scenes, or other digital screens behind the transparent display.

Flexible Design Options

The Planar LookThru OLED transparent display measures 55-inch in diagonal. It can be used in both portrait and landscape modes, and can be table mounted, ceiling mounted, or built into custom fixtures using the straight flush-mount design. It can also be tiled to create large, eye-catching video wall arrays. The Planar LookThru OLED transparent display is available with optional touch screen interactivity, offering 32 simultaneous touch points.

Brilliant Picture Quality in a Large Viewing Size

The Planar Lookthru OLED transparent display offers vibrant colors greater than 100 percent National Television System Committee (NTSC) performance as well as wide viewing angles with no off-axis contrast or brightness limitations. The display provides Full HD resolution that allows for beautiful graphics and full-motion video.

High Durability

The Planar LookThru OLED display features the proprietary [Planar® Extended Ruggedness and Optics™](#) (ERO™) technology, which uses a protective optically-clear Corning® Gorilla® Glass bonded to the front surface of the display. This high-durability surface can withstand the rigors of high-traffic environments and interactive touch.

Source Compatibility

The Planar LookThru OLED transparent display comes with standard digital inputs including HDMI and DisplayPort, is fully controllable using RS-232, LAN, Crestron and other control systems, and is compatible with sources ranging from PCs and players to consumer video devices that rely on High-bandwidth Digital Content Protection (HDCP) compliance. The display is compatible with processing solutions from Planar including the [Clarity® Visual Control Station™](#) (VCS™) for tiling applications or advanced source management.

Safety Information

Before using your Planar LookThru LO55 transparent OLED display, please read this manual thoroughly to help protect against damage to property and to ensure personal safety.

Be sure to observe the instructions

For your safety, be sure to observe ALL the warnings detailed in this manual.

For installation or adjustment, please follow this manual's instructions and refer all servicing to qualified service personnel.

Safety Precautions

- **If water is spilled or objects are dropped inside the display, remove the power plug from the outlet immediately.** Failure to do so may result in fire or electrical shock. Contact your dealer for inspection.
- **If the display is dropped or the chassis is damaged, remove the power plug from the outlet immediately.** Failure to do so may result in fire or electrical shock. Contact your dealer for inspection.
- **If the power cord or plug is damaged or becomes hot, turn off the main power switch of the display. Make sure the power plug has cooled down and remove the power plug from the outlet.** If the display is still used in this condition, it may cause a fire or an electrical shock. Contact your dealer for a replacement.

Caution: Wall and/or support mounts must be secure.

If a display or displays are hung from a wall or some other support, the structure must be verified as able to safely sustain the weight of the assembly. Simply mounting to wallboard or wall paneling won't be adequate or safe.

Important Safety Instructions

- 1** Read these instructions.
- 2** Keep these instructions.
- 3** Heed all warnings.
- 4** Follow all instructions.
- 5** Do not use Planar LookThru LO55 displays outdoors or near water.
- 6** Do not install near any heat sources such as radiators, heat registers, stoves or other apparatus that produce heat.
- 7** Do not defeat the safety purpose of a polarized or grounding type plug. The polarized plug has two blades with one wider than the other. A grounding type plug has two blades and a third grounding prong. The wide blade or the third prong is provided for your safety. When the provided plug does not fit into your outlet, consult an electrician for the replacement of the obsolete outlet.
- 8** Protect the power cord(s) from foot traffic or kinks particularly at plugs, convenience receptacles and the point where they exit from any of the Planar LookThru displays.
- 9** You should only use replacement parts, accessories and other components specified by Planar Systems.
- 10** Unplug all Planar LookThru displays during lightning storms or when unused for long periods of time.
- 11** You must follow all National Electrical Code regulations. In addition, be aware of local codes and ordinances when installing your system.
- 12** Refer all servicing to qualified service personnel. Servicing is required when any Planar LookThru displays have been damaged in any way, such as when the AC power cord or plug is damaged, liquid has been spilled or objects have fallen into a product, the products have been exposed to rain or moisture, do not operate normally or have been dropped.
- 13** You should consider keeping the packing materials in case the equipment ever needs to be shipped.
- 14** Wall mounts must be secure. The wall must be strong enough to hold all Planar LookThru displays, mounting plates, cables and accessories. Weights and dimensions of components of your display are found in the "Specifications" section on page 61.

Recommended Usage

In order to get the most from your Planar LookThru LO55 LookThru Transparent OLED display, use the following recommended guidelines to optimize the display.

Planar LookThru displays are designed for fixed installation, indoor use only.

Normal use definition: 12 hours per day at 25°C, moving image, 75 nits average luminance

In use the Planar LookThru display should be operated in the open air to prevent heat buildup and without direct or indirect heat sources such as nearby lighting fixtures or heating ducts that can cause the display to experience elevated temperatures.

If the display will be installed in a recessed area with a surround trim or other enclosing feature around the Planar LookThru LO55 Electronics Box, ensure adequate openings are provided for proper air flow and ventilation.

At sea level, the maximum ambient operating temperature for the Planar LookThru display cannot exceed 40° C nor be below a minimum ambient operating temperature of 0° C (as measured within ~ 2 feet (0.6 m) of the Electronics Box). If one of these conditions is exceeded, it is up to the installer to ensure that display placement is changed, thermal shielding is provided, and/or additional ventilation is provided to keep the system within its nominal operating parameters.

For proper cooling, the Electronics Box should not be mounted closer than the spacing described in the "Requirements for All Installations" section on page 20 to any continuous surface. The perforated sheet metal on all sides of the Planar LookThru Electronics Box must be kept clear of obstruction or any sort of cover.

European Disposal Information

English	Français	Deutsch
<p><input type="checkbox"/> Disposal of old Electrical & Electronic Equipment (Applicable throughout the European Union and other European countries with separate collection programs)</p> <p>This symbol found on your product or on its packaging, indicates that this product should not be treated as household waste when you wish to dispose of it. Instead, it should be handed over to an applicable collection point for the recycling of electrical and electronic equipment. By ensuring this product is disposed of correctly, you will help prevent potential negative consequences to the environment and human health, which could otherwise be caused by inappropriate disposal of this product. The recycling of materials will help to conserve natural resources.</p>  <p>This symbol is only valid in the European Union. If you wish to discard this product, please contact your local authorities or dealer and ask for the correct method of disposal.</p>	<p><input type="checkbox"/> Mise au rebut des équipements électriques et électroniques usagés (valable dans l'ensemble de l'Union Européenne ainsi que dans les pays européens disposant de programmes distincts de collecte des déchets)</p> <p>Ce symbole appliqué sur votre produit ou sur son emballage indique que ce produit ne doit pas être traité comme un déchet ménager lorsque vous voulez le mettre au rebut. Il doit au contraire être remis à un site de collecte agréé pour le recyclage des équipements électriques et électroniques. En veillant à ce que ce produit soit mis au rebut de façon adéquate, vous contribuez à prévenir les conséquences potentiellement négatives sur l'environnement et sur la santé humaine qui risqueraient de se produire en cas de mise au rebut inappropriée de ce produit. Le recyclage des matériaux contribuera également à économiser les ressources naturelles.</p>  <p>Ce symbole n'est valable que dans l'Union Européenne. Si vous souhaitez mettre ce produit au rebut, veuillez prendre contact avec les autorités locales ou avec votre revendeur et renseignez-vous sur la méthode de mise au rebut correcte.</p>	<p><input type="checkbox"/> Entsorgung von elektrischen & elektronischen Ausrüstungen (gültig für die europäische Gemeinschaft und andere europäische Länder mit separaten Sammelprogrammen)</p> <p>Dieses Symbol, zu finden auf Ihrem Produkt oder dessen Verpackung, macht Sie darauf aufmerksam, dass dieses Produkt bei der Entsorgung nicht als Hausmüll behandelt werden darf. Stattdessen sollte es an eine Sammelstelle zum Recycling von elektrischen und elektronischen Ausrüstungen gegeben werden. Helfen Sie mit, potentiell schädliche Einflüsse auf Umwelt und Gesundheit, die durch eine unangemessene Entsorgung dieses Produktes entstehen können, zu vermeiden und entsorgen Sie dieses Produkt ordnungsgemäß. Recycling hilft, natürliche Rohstoffe einzusparen.</p>  <p>Dieses Symbol ist nur innerhalb der europäischen Gemeinschaft gültig. Wenn Sie dieses Produkt entsorgen möchten, wenden Sie sich bitte an Ihre örtliche Behörde und fragen Sie nach der ordnungsgemäßen Entsorgungsmethode.</p>
<p><input type="checkbox"/> Deshacho de equipos eléctricos y electrónicos (aplicable a la Unión Europea y a otros países europeos con programas de reciclaje independientes)</p> <p>La presencia de este símbolo en el propio producto o en su material de embalaje, indica que no se debe tratar como residuo doméstico cuando desee deshacerse de él. En su lugar, debe entregarse en el punto limpio correspondiente de reciclaje de equipos eléctricos y electrónicos. Asegurándose de que este producto se desecha de forma correcta, ayudará a evitar posibles consecuencias negativas para la conservación del medioambiente y la salud humana, consecuencias que podrían darse si se desecha del producto de forma inadecuada. El reciclado de materiales ayuda a conservar los recursos naturales.</p>  <p>Este símbolo solamente es válido en la Unión Europea. Si desea deshacerse de este producto, póngase en contacto con las autoridades locales o con su distribuidor y pida información sobre el método de disposición adecuado.</p>	<p><input type="checkbox"/> Smaltimento delle attrezzature elettriche ed elettroniche usate (applicabile in tutta la Comunità Europea ed altri Paesi Europei che applicano programmi di raccolta differenziale)</p> <p>Il simbolo trovato sul prodotto, o sulla sua confezione, indica che il prodotto non può essere trattato come i domestici quando è il momento di smaltirlo. Al contrario, deve essere consegnato ad un centro di raccolta specializzato nel riciclaggio di attrezzature elettriche ed elettroniche. Assicurando che il prodotto è smaltito di questo modo, si evitano le prevenite possibili conseguenze negative sull'ambiente e sulla salute umana, che possono essere provocate da uno smaltimento di questa attrezzatura. I materiali riciclati aiuteranno a conservare le risorse naturali.</p>  <p>Questo simbolo è valido solo nell'Unione Europea. Per smaltire questo prodotto, mettersi in contatto con le autorità locali - o con il rivenditore - e chiedere informazioni sul corretto metodo di smaltimento.</p>	<p><input type="checkbox"/> Verwijderen van oude elektrische en elektronische apparatuur (toepasselijk in de volledige Europese Unie en andere Europese landen met afzonderlijke programma's voor afvalverzameling)</p> <p>Dit symbool dat op het product of zijn verpakking is aangebracht, geeft aan dat dit product niet mag worden behandeld als huishoudelijk afval als u het wilt wegwerpen. U moet het afgeven bij een specifiek verzamelpunt voor de recycling van elektrische en elektronische apparatuur. Door te garanderen dat u dit product op de correcte manier wegwerpt, helpt u potentiële negatieve gevolgen voor het milieu en de menselijke gezondheid, die zouden kunnen worden veroorzaakt door een onrechtmatig wegwerpen van het product, te voorkomen. De recycling van materialen helpt het behoud van natuurlijke bronnen.</p>  <p>Dit symbool is alleen geldig in de Europese Unie. Als u dit product wenst weg te gooien, dient u contact op te nemen met uw lokale instanties voor details over de gepaste methode voor afvalverzameling.</p>
<p><input type="checkbox"/> Eliminação de equipamentos elétricos e eletrônicos usados (aplicável na União Europeia e noutros países europeus com programas próprios de recolha destes equipamentos)</p> <p>Este símbolo, colocado no produto ou na respectiva embalagem, indica que o produto não deve ser tratado como lixo doméstico aquando da sua eliminação. Em vez disso, deve ser entregue num ponto de recolha de equipamentos elétricos e eletrónicos para posterior reciclagem. Ao garantir a correcta eliminação deste produto, evitará e evitará consequências potencialmente negativas tanto para o ambiente como para a saúde humana. A reciclagem de materiais ajuda a preservar os recursos naturais.</p>  <p>Este símbolo apenas é válido na União Europeia. Se quiser eliminar este produto, contacte as entidades locais ou o seu fornecedor para ficar a saber qual o método de eliminação correcto.</p>	<p><input type="checkbox"/> Usowanie zużytego sprzętu elektrycznego i elektronicznego (dotyczy krajów Unii Europejskiej i innych krajów europejskich z oddzielnymi programami zbiórki odpadów)</p> <p>Obecność tego symbolu na produkcie lub na opakowaniu z produktem oznacza, że tego produktu nie można wyrzucić razem z odpadkami domowymi. Należy go przekazać do punktu zbiórki w celu poddania recyklingowi zużytego sprzętu elektrycznego i elektronicznego. Ubezpieczenie tego produktu w prawidłowy sposób, pomoże w zabezpieczeniu przed negatywnym wpływem odpadów na środowisko i zdrowie ludzi, powodowanym przez niewłaściwe użycie produktu. Przetwarzanie materiałów pomaga w zachowaniu zasobów naturalnych.</p>  <p>Ten symbol obowiązuje wyłącznie w krajach Unii Europejskiej. Informacje dotyczące prawidłowej metody użycia tego produktu, można uzyskać u władz lokalnych lub u dostawcy.</p>	<p>Waste Electrical and Electronic Equipment (WEEE) Directive In the European Union, this label indicates that this product should not be disposed of with household waste. It should be deposited at an appropriate facility to enable recovery and recycling. EEE complies with Directive 'Regulation on the Restriction of the Use of Certain Hazardous Substances in Electrical and Electronic Equipment'</p>  <p>Waste Electrical and Electronic Equipment (WEEE) Directive In the European Union, this label indicates that this product should not be disposed of with household waste. It should be deposited at an appropriate facility to enable recovery and recycling. EEE complies with Directive 'Regulation on the Restriction of the Use of Certain Hazardous Substances in Electrical and Electronic Equipment'</p>
<p><input type="checkbox"/> Avfall av förbrukad elektriska och elektroniska utrustning (Tillämpbart i hela Europeiska unionen och andra europeiska länder med separata samlingsprogram)</p> <p>Den här symbolen som finns på din produkt eller på dess förpackning påvisar att produkten inte ska behandlas som hushållsavfall när du vill slänga bort den. Istället ska den lämnas över till en lämplig samlingspunkt för återvinning av elektriska och elektroniska utrustningar. Genom att följa detta att den här produkten återvinnas på ett riktigt sätt hjälper du till med att förhindra möjliga negativa konsekvenser för miljön och mänsklig hälsa. Det kan annars orsakas på grund av olämplig sophantering av den här produkten. Återvinning av material kommer att hjälpa till att bevara naturtillgångar.</p>  <p>Den här symbolen är endast giltig inom den Europeiska unionen. Om du vill slänga bort den här produkten ska du kontakta lokala myndigheter eller återförsäljare, och fråga efter lämpliga avfallsmetoder.</p>	<p><input type="checkbox"/> Vurhojen sähkösä ja elektronikkalaitteiden hävittäminen (Soveltuva kaikilla Euroopan unionin alueilla, sekä muissa Euroopan maissa, jolla on erilliset keräysohjelmat)</p> <p>Jos tuotteen tai sen pakkausten on tämä symboli, sitä ei päästä hävittäessä kotonaan tavalliseen kotijätteenpöytä, vaan se kuuluu toimittua sähkösä ja elektronikkalaitteiden kierrätysjärjestelmään. Varmistamalla, että tämä tuote hävitetään asianmukaisella tavalla autat estämään mahdollisia ympäristö- ja ihmisten terveyttä negatiivisia seurauksia, jotta sen väärinlaitteen hävittäminen voi aiheuttaa. Materiaalien kierrättäminen auttaa säälyttämään luonnonvaroja.</p>  <p>Tämä symboli on voimassa ainoastaan Euroopan unionin alueella. Jos haluat hävittää tämän tuotteen, ota yhteyttä paikallisiin viranomaisiin tai jälkeenvälittäjään ja tiedustele asianmukaisia hävittämisohjelmia.</p>	<p>Waste Electrical and Electronic Equipment (WEEE) Yönergeleri Avrupa Birliği'nde bu etiket, ürünün ev elektroniği aletleri atıkları ile imha edilemeyeceğini gösterir. Kurtarmak ve geri dönüştürümü için uygun şartlarda saklanması gerekir. EEE Yönetmeliğine Uygundur Ve Elektronik Eşyalarla Bazı Zararlı Maddelerin Kullanımının Sınırlanmasında Dair Yönetmelik.</p>  <p>Waste Electrical and Electronic Equipment (WEEE) Yönergeleri Avrupa Birliği'nde bu etiket, ürünün ev elektroniği aletleri atıkları ile imha edilemeyeceğini gösterir. Kurtarmak ve geri dönüştürümü için uygun şartlarda saklanması gerekir. EEE Yönetmeliğine Uygundur Ve Elektronik Eşyalarla Bazı Zararlı Maddelerin Kullanımının Sınırlanmasında Dair Yönetmelik.</p>

Tour of the Planar LookThru Transparent OLED Product Family

Display Architecture

The four members of the Planar LookThru LO55 product family are described in this section:

- LO55 Standard Model
- LO55-S Straightmount Model
- LO55-T Standard Model with Touch
- LO55-ST Straightmount Model with Touch

All four of these Planar LookThru LO55 models are made up of three subcomponents:

- Display Glass
- Display Chassis
- Electronics Box

The Standard Model of the Planar LookThru LO55, pictured on the right, is intended for use on a countertop or attached to a suitable surface, either upright as shown, inverted (landscape mode) or side-mounted in portrait mode. Tiled installation is also possible.

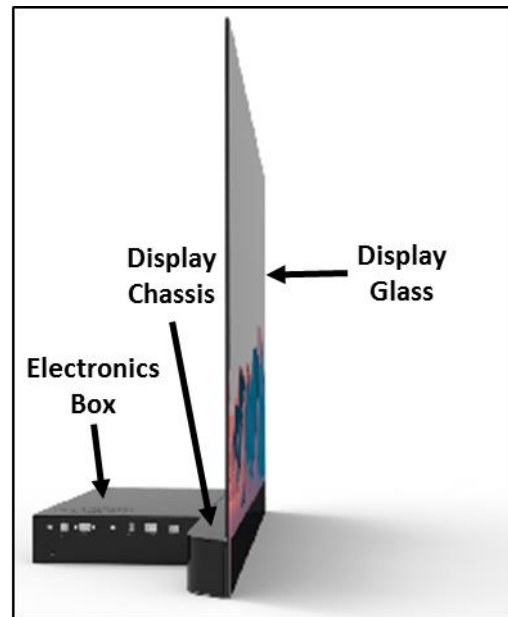

The Display Glass consists of a two pieces of 2 mm thick Corning Gorilla Glass and a 55-inch diagonal TAMOLED (Transparent Active Matrix Organic Light Emitting Diode) panel. These components are optically bonded together employing the proprietary Planar ERO process. Use of Planar ERO results in a combination of optimum optical performance and ruggedness. The glass assembly, featuring a front surface anti-reflective coating, is less than 8 mm thick. Bezel dimension on the two short sides of the Display Glass is 5.9 mm while on the long axis opposite the Display Chassis the bezel dimension is 6.9 mm.

The Display Glass should never be used as the main load-bearing element for mounting or as a primary handle or principal support during transport.

The Display Glass is securely joined to the display where that attachment surface creates the bottom bezel for the Planar LookThru LO55. That bezel width is 98 mm. The Display Chassis also incorporates the five primary M6 mounting points. Leveling feet are installed in three of these mounting points in the Planar LookThru LO55 and LO55-T. The feet should be removed for a fixed mounting installation. No fewer than three of the primary mounting holes are

recommended to be used for any installation. The Display Chassis is the part of the display to use as a primary handhold during transport and mounting.

There are five secondary M6 mounting points on the underside of the Electronics Box. These should only be used together with the primary mounting points on the Display Chassis, but never by themselves. A counter weight is attached to the underside of the Electronics Box in the Planar LookThru LO55 and LO55-T. The counter weight also serves to create an acceptable open space for ventilation on the underside of the display. Like the leveling feet, it should be removed for a fixed mount installation, but provisions must be made for the proper 5 mm inch spacing.

Note that the corners of the Display Chassis and the right side (viewed from the front) of the Electronics Box are chamfered at a 45° angle, allowing a corner or right-angle installation of Planar LookThru LO55 displays. This is a feature found in all the LO55 family of displays. The bottom view of a Planar LookThru LO55 in the figure below illustrates the corner chamfers. The leveling feet and counterweight are also shown.

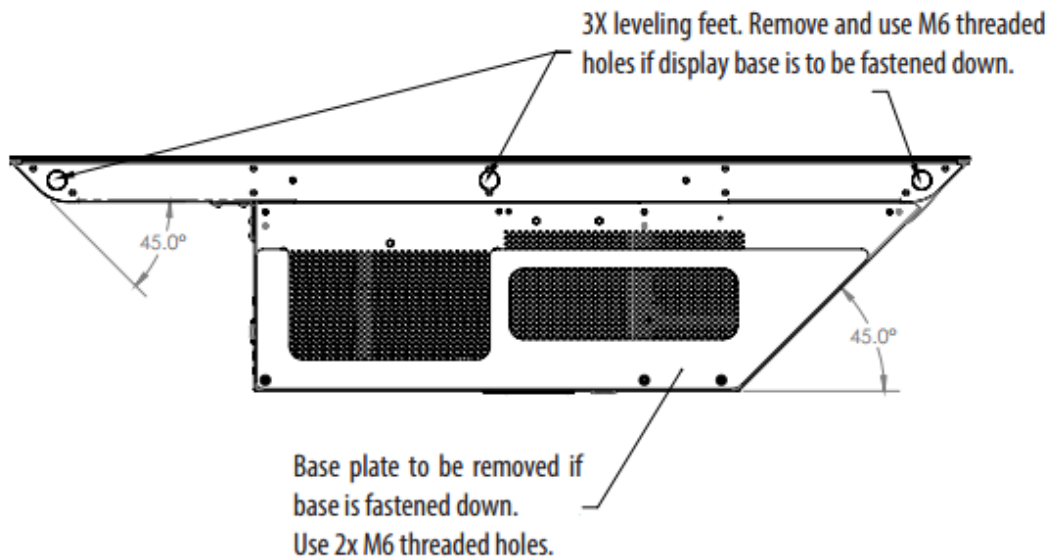

The backside of the Electronics Box also contains the controlling I/O for the display. This is shown in the figure below. The power switch and power cord receptacle are centered on the backside.

The keypad is described in detail in the “OSD Keypad” section on page 23. There are four HDMI inputs, two each of Rev. 2.0 and Rev 1.4. There is one DisplayPort input and one DisplayPort output. The RS-232 and LAN connectors are found on the right side of the Electronics Box along with the jack for the remote sensor as well as USB-A and USB-B ports.

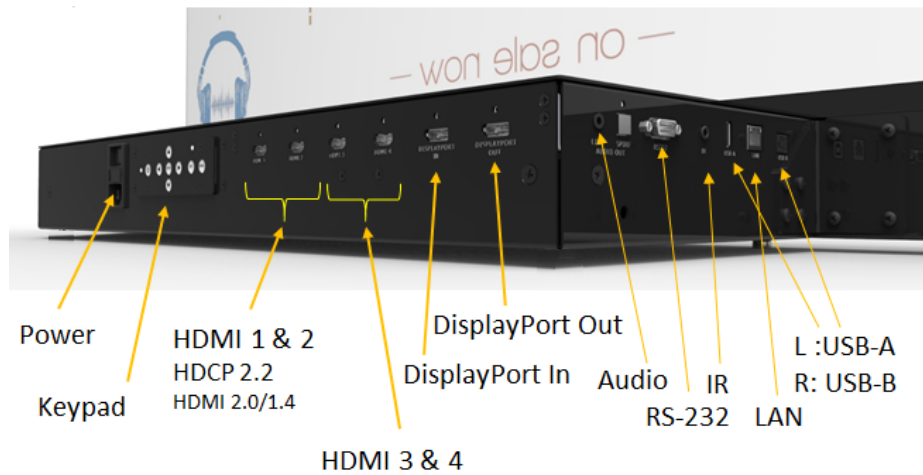

Note there is no fan in any of Planar LookThru LO55 family of displays.

The Straightmount Model, the Planar LookThru LO55-S, on the right, is intended to allow mounting on a wall or partition where space behind the Display Chassis is an issue. Like the Standard Model, the Planar LookThru LO55-S can be used in the tiled configuration. The Planar LookThru LO55-S differs from the Standard Model in that the Electronics Box has been relocated 90° downward compared to the Planar LookThru LO55. It is functionally identical to the Planar LookThru LO55. The Planar LookThru LO55-S can be mounted in upright or inverted in landscape mode or in either orientation in portrait mode. A corner installation of multiple LO55-S displays is also possible.

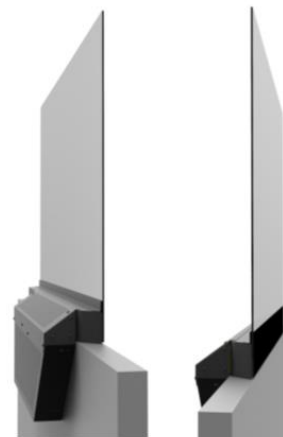

Note that the Straightmount Model is not intended for standalone use; it can only be used when attached to some sort of support.

The primary mounting points on the Display Chassis must be employed for attachment. The secondary mounting points on the Electronics Box can also be used, but only along with the primary points.

The Planar LookThru LO55-T and the Planar LookThru LO55-ST incorporate IR touch into the Standard and Straightmount Models, respectively. These are shown below. A maximum of 32 simultaneous touches is possible. The touch frame is incorporated into a frame mounted to the Display Glass. The touch models are not intended for use in a tiled installation.



Like the Straightmount Model described above, the Straightmount Touch Model can only be installed where a fixed mounting is used. It is not designed to stand alone.

The four models of the Planar LookThru LO55 display family are summarized in the table below:

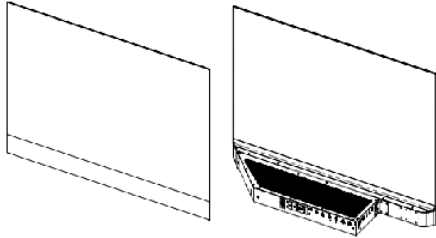
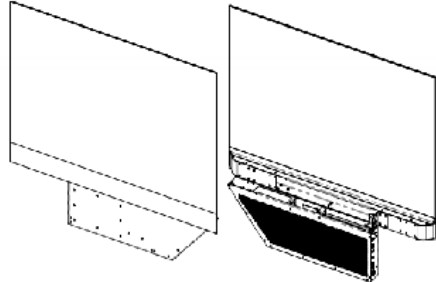
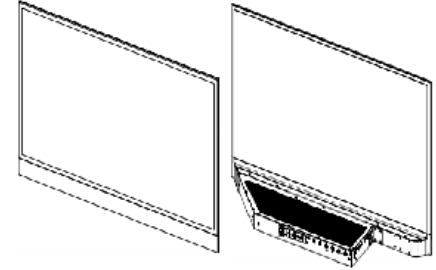
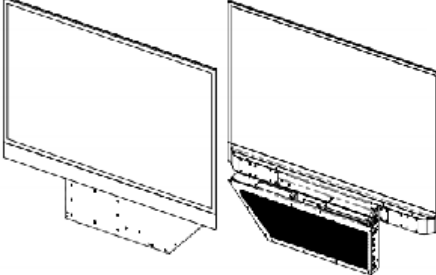
Planar LookThru Transparent OLED Model	Part Number	Description	Figure
LO55	997-8219-xx	Standard Model	
LO55-S	997-8220-xx	Straightmount Model	
LO55-T	997-8244-xx	Standard Model with Touch	
LO55-ST	997-8245-xx	Straightmount Model with Touch	

Additional Components Shipped with Every Display

Remote Control and Sensor

A remote control, used to access the OSD, is included with all displays. Refer to “Using the Remote Control” on page 24 for details on operation and function. A remote control sensor is also included that increases the range of the remote control.

Cable Cover

The cable cover fills in the right angle section of the Electronics Box but still allows access to the I/O features. It attaches with three screws. See figure below and on the right.

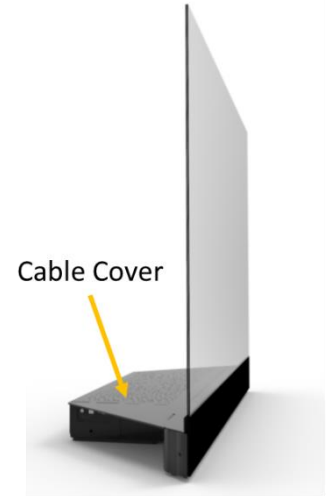

Never use the cable cover to assist in the lifting or moving the display.

Cables

One HDMI and one 110VAC cable is included.

Fasteners

The three screws for the cable cover are included in a plastic bag. Jackscrews are also included that can be used with HDMI cables having a locking connector.

USB Stick

The included USB stick contains the following:

- User’s Manual
- Content Developer’s Guide
- Fabricator’s Guide

Accessories

Platform Cover

The perforations in the Electronics Box must not be covered significantly in any way. Rather than placing items of interest on the Electronics Box, we recommend the use of the Platform Cover that consists of the sheet metal plate and support feet. There are two magnetic feet that attach to the steel components of the Display Chassis. The figure on the right illustrates the use of the Platform Cover.

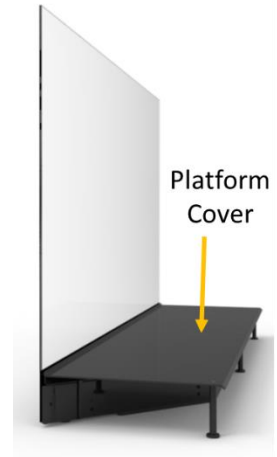

Tiling Hardware

The Tiling Hardware can be used in tiled installations, either for flat or corner mounts. There are four tiling assemblies, all made of up of an interlocking front and back component:



Plus sign shape for flat (2x2 Panels)



T-shape for flat (2x1 Panels)



Plus sign shape for right angle (2x2 Panels)

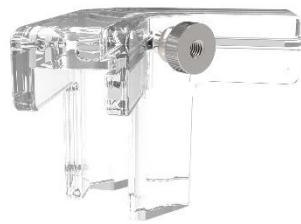

T-shape for right angle (2x1). This is recommended for use in Nx1 landscape right angle installations or to terminate tiled portrait mode systems.

Refer to the “Multiple Displays” section on page 22 for proper use. Examples of Tiling Hardware usage is illustrated in the figures below:



Here is an example of a tiled LO55 installation showing use of the Tiling Hardware:



Base Plates

The Base Plates are used with the Planar LookThru LO55 (standard version) for ceiling, wall or tabletop mounting. Base Plates support either landscape or portrait orientation and doesn't restrict airflow unacceptably through the perforations in the Electronics Box. The placement of the mounting holes in the mounting plates accommodate 16 inch centers. With the use of connecting plates, the Base Plates can be attached to an adjacent display. See the top and bottom views in the figures below.

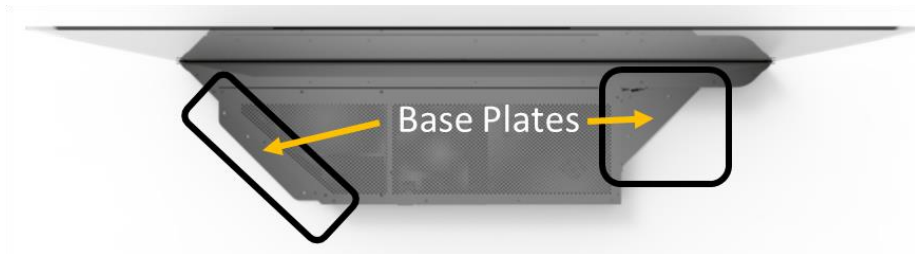

Unpacking and Installing the Display

Safe Handling

- When removing the display from its shipping box, use the indicated handhold locations shown in the picture below. You should also grip the underside of the Display Glass in lifting the display from the shipping box.

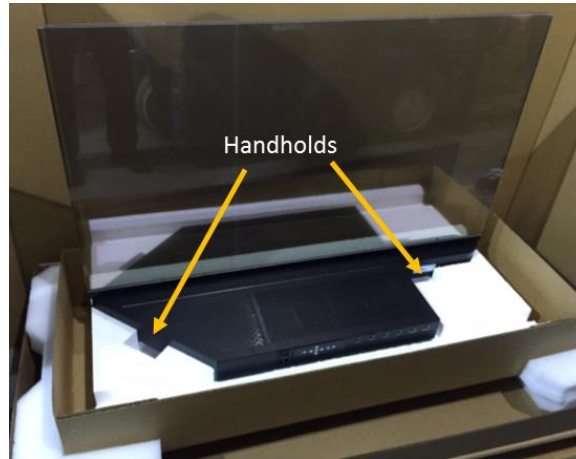

- We recommend the display be handled by at least two people. At no time should the glass be held where the weight of the display is borne by the glass. Proper handling is demonstrated in the picture below.



- Be certain any surface where the display(s) will be placed can safely support the 74.0 lbs (33.6 kg) weight of the display.
- We recommend using the shipping box for transport whenever possible.

Environmental Considerations

- The Planar LookThru LO55 is intended for indoor use only.
- Displays should only be installed in an environment where the temperature and humidity are kept within the proper use range. See the Environmental Specifications on page 61.
- Planar LookThru LO55 displays should not be operated on a carpet that can stifle ventilation through the perforations in the underside of the Electronics Box.
- Planar LookThru LO55 displays are not designed to be sunlight readable.
- Do not locate the displays in direct sunlight or where the Display Glass will be exposed to ultraviolet (UV) light.
- The electronic box should not be located near heat sources or in an environment where there is less than 0.47 inches (12 mm) of free space on all sides. Note that the Display Glass and the Display Chassis do not rise in temperature much above ambient during operation.
- For best use of the display transparency, make certain there is adequate illumination in the space behind the screen so that items of interest can be viewed optimally through the display. We recommend you experiment with the level and orientation of the illumination.

Installation Disclaimer

Proper installation of the display is the responsibility of the end customer. Failure to follow the safety and installation instructions in this manual, Content Developer's Guide or Fabricator's Guide, or any installation of the display in a manner not described in this manual, Content Developer's Guide or Fabricator's Guide, may result in damage to the display or unsafe conditions, which will not be covered by the product warranty.

Requirements for All Installations

Make sure the surface or structure where the display is to be mounted is capable of supporting the weight of the display or displays to be used. Consult the "Specifications" section on page 61 for weights and measures.

If the display is to be attached to a surface or structure, use the five M6 mounting points in the Display Chassis as the primary attachment point. The mounting holes in the Electronics Box employed can provide supplementary support but should not be used for mounting by themselves. No fewer than three of primary mounting holes should be used in any installation.

Make sure the Display Glass maintains a neutral position and is not loaded in any way. The front Display Glass surfaces should be mounted straight and plumb, i.e. perpendicular to the horizontal in all axes.

For mounting a Planar LookThru LO55 or LO55-T, the leveling feet and counterweight must be removed. Using two people, we recommend carefully laying the Display Glass on a suitable countertop with a soft surface with the Electronics Box perpendicular to the counter. The leveling feet and counterweight can then be removed safely.

The perforations in the Electronics Box are a part of the thermal management system and should never be covered or have any solid surface be located closer than what is defined in the figure below. This keep-out restriction does not apply under or on top of the Display Chassis.

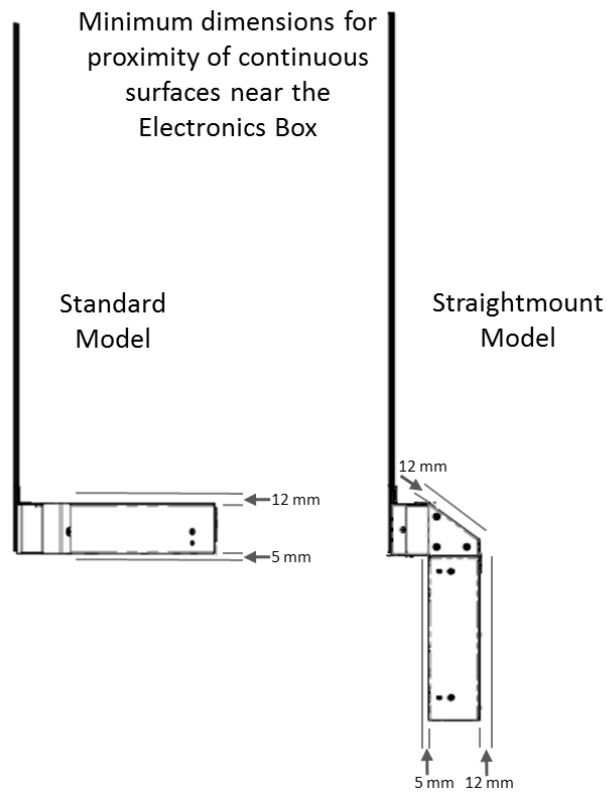

We do not recommend that either of the Straightmount Models be mounted where the weight of the display is carried by the bottom surface of the Electronics Box.

Multiple Displays

In an installation where one or more displays are mounted above one another, make certain each display is mounted independently. The weight of a display or displays mounted above another should not be borne by the lower display.

The Display Glass must be properly aligned and plumb before attachment of the tiling hardware. The tiling hardware should not be used to bring the Display Glass into alignment. This will create a permanent load on the glass. Shim and adjust placement of the display at the mounting points to bring the glass into proper position.

Do not overtighten the tiling hardware.

Multi-Display, User-Provided Touch

Planar does not support touch for tiled applications.

Operating the Display

OSD Keypad

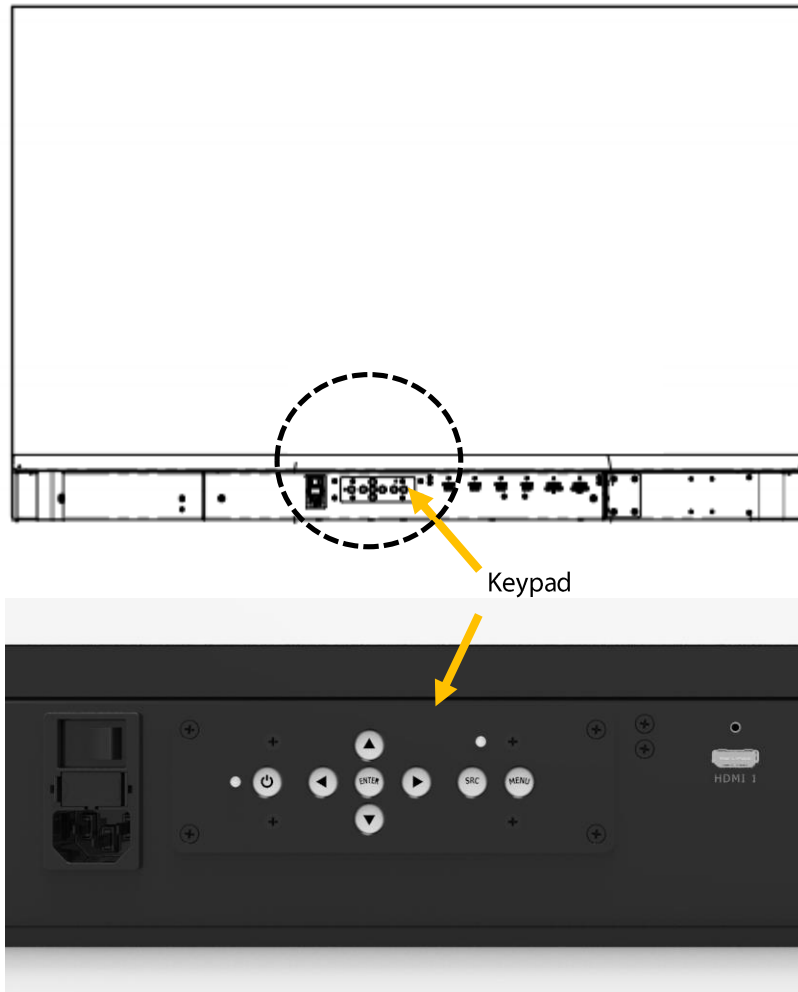

OSD Keypad Buttons

Key	Descriptions
Power	Power on/Power off
◀	Menu Left/Decrease value
▶	Menu Right/Increase value
▲	Menu Up/Increase volume
▼	Menu Down/Decrease volume
Menu	Menu/Exit
SRC	Source selection (toggle)

Using the Remote Control

The Remote Control included with every Planar LookThru LO55 model is shown below. An IR sensor is located beneath the perforated cover in the back center of the Electronics Box. The shaded triangles in the figures below indicate the approximate range of coverage of that sensor. Note this includes access through the front side of the glass.

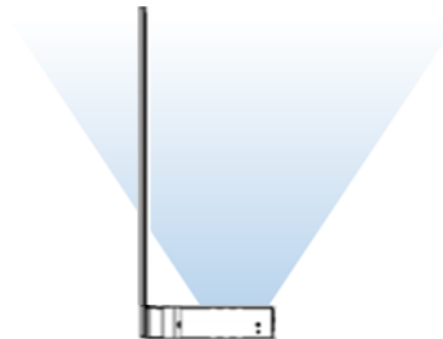
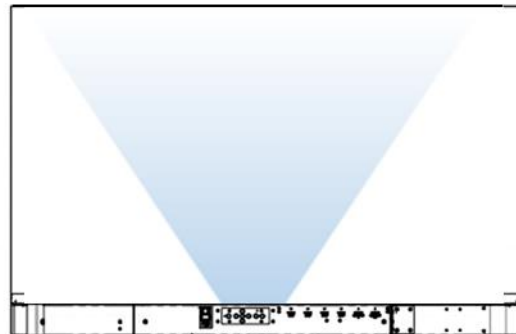

Each remote control is shipped with the same identification code, 01785. If you wish to change this code so, for example, individual displays can be controlled separately, the reprogramming process follows. Both the display and the remote control need to be programmed:

Display

- 1 Navigate to **Advanced Settings > System Settings > IR Remote Code**.
- 2 Press the Enter key to start editing the code.
- 3 Using the numeric keypad on the remote, enter a new code (max value is 0xFFFF or 65,535).
- 4 Press the Enter key to confirm the entry.

Remote Control

- 1 On the IR Remote, hold down the **Code** key for 5 seconds. The red LED on the remote should turn on and remain on.
- 2 Enter the same code you entered on the display (including leading zeros).
- 3 Once five digits have been entered, the LED should turn off. Your remote has been programmed.

Comments

- The RS-232 command "IR.Code=XXXXX" may also be used to program the display only.
- If a valid code is not entered and no keys are pressed for 30 seconds, the light will turn off and the remote will exit programming mode

To expand the coverage of the remote control, an IR sensor with a 112-inch (2850 mm) long cable is included with every LO55 model, shown on the right. The phone jack plugs into the port marked "IR" on the perpendicular backside of the display.



External Control

In addition to using the Planar remote control and keypad, there are other methods of controlling the Planar LookThru LO55 display externally:

- Using a serial link to send ASCII commands and to receive responses to those commands. The same set of commands can be sent over RS 232, TCP or UDP. See the *Planar LookThru RS232 User Manual* for more details.
- Using the discrete infrared (IR) codes to program a third-party remote control. See the "IR Command Protocol" section, next.

IR Command Protocol

The Planar LookThru displays accept commands in the form of IR signals that conform to the NEC protocol. Each Planar LookThru remote control has an NEC control code associated with it. You can use these codes to program a third-party “universal” remote control to work with the Planar LookThru displays. These third-party products usually come with a computer software application for this purpose. For more information, consult the documentation provided with the remote control.

The IR control codes have the following characteristics:

- Each code consists of the following:
 - A leader pulse (a modulated pulse of 9 ms followed by a non-modulated pulse of 4.5 ms)
 - 16 address bits. The default address is 1785 (0x06F9, binary 00000110 11111001)
 - 16 data bits: eight (8) bits for the command followed by the logical inverse of the command
 - An end pulse (a modulated pulse of 0.56 ms, similar to the modulated pulse in the ‘0’ and ‘1’ bits). The end of the modulated pulse constitutes the end of the data transmission.
- The carrier frequency is 38 kHz, with the modulated pulses having a 33% duty cycle.
- Commands are sent at a maximum rate of 9 Hz.

For example, below is the NEC control code for the ON button of the Planar LookThru remote control (assuming the default address is used).

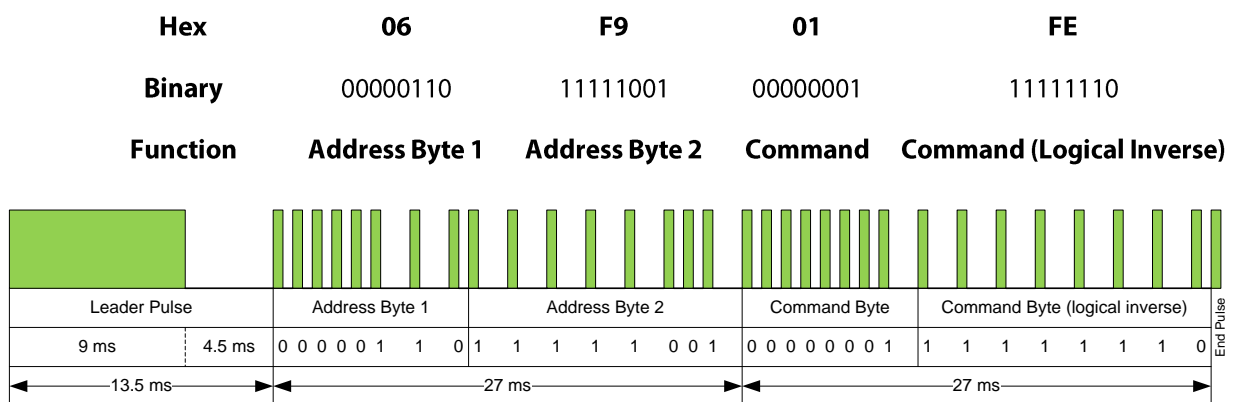

Remote Control Button Name	Address	Data	NEC Data From Remote (Hex Code)	Description
ON	1785	1	0x06F901FE	Power on
OFF	1785	9	0x06F909F6	Power off
◀	1785	2	0x06F902FD	Not used
▶	1785	3	0x06F903FC	Not used
**	1785	6	0x06F906F9	Not used
PRESETS	1785	4	0x06F904FB	Opens the Presets menu
PRESET 1	1785	5	0x06F905FA	Applies Preset 1
PRESET 2	1785	7	0x06F907F8	Applies Preset 2
PRESET 3	1785	8	0x06F908F7	Applies Preset 3
PRESET 4	1785	10	0x06F90AF5	Applies Preset 4
1	1785	12	0x06F90CF3	Number button 1
2	1785	13	0x06F90DF2	Number button 2
3	1785	14	0x06F90EF1	Number button 3
4	1785	15	0x06F90FF0	Number button 4
5	1785	16	0x06F910EF	Number button 5
6	1785	17	0x06F911EE	Number button 6
7	1785	20	0x06F914EB	Number button 7
8	1785	25	0x06F919E6	Number button 8
9	1785	27	0x06F91BE4	Number button 9
0	1785	18	0x06F912ED	Number button 0
VOL +	1785	28	0x06F91CE3	Volume increase
VOL -	1785	33	0x06F921DE	Volume decrease
MUTE	1785	32	0x06F920DF	Audio mute
COLOR	1785	19	0x06F913EC	Not used
VIDEO WALL	1785	34	0x06F922DD	Not used
MISC	1785	11	0x06F90BF4	Not used
MENU	1785	21	0x06F915EA	Opens the menu
PREV	1785	22	0x06F916E9	Returns to the previous menu
ENTER	1785	23	0x06F917E8	Selects the current menu item
UP	1785	26	0x06F91AE5	Navigate up
DOWN	1785	29	0x06F91DE2	Navigate left

Remote Control Button Name	Address	Data	NEC Data From Remote (Hex Code)	Description
LEFT	1785	31	0x06F91FE0	Navigate right
RIGHT	1785	24	0x06F918E7	Navigate down
TOP	1785	30	0x06F91EE1	Selects the top line in the current menu
ZONE 1	1785	35	0x06F923DC	Selects the input for Zone 1
ZONE 2	1785	36	0x06F924DB	Selects the input for Zone 2
ZONE 3	1785	38	0x06F926D9	Selects the input for Zone 3
ZONE 4	1785	39	0x06F927D8	Selects the input for Zone 4
PIP MODE	1785	37	0x06F925DA	Selects the Multi-Source View setting
PIP SWAP	1785	40	0x06F928D7	Swaps the main and PIP windows
HDMI 1	1785	41	0x06F929D6	Selects HDMI 1 for the current zone
HDMI 2	1785	42	0x06F92AD5	Selects HDMI 2 for the current zone
HDMI 3	1785	43	0x06F92BD4	Selects HDMI 3 for the current zone
HDMI 4	1785	44	0x06F92CD3	Selects HDMI 4 for the current zone
DP	1785	45	0x06F92DD2	Selects DP for the current zone
DVI	1785	46	0x06F92ED1	Not used
VGA	1785	47	0x06F92FD0	Not used
OPS	1785	48	0x06F930CF	Not used

Locking the Keypad and IR Remote

You can lock the keypad and IR remote functionality on the display. To lock the keypad, go to **Main Menu > Advanced Settings > System Settings** and select **Keypad Lock**. To lock the IR remote, go to **Main Menu > Advanced Settings > System Settings** and select **IR Remote Lock**.

Unlocking the Keypad and IR Remote

To unlock the keypad, press the following keys on the keypad in the order listed: UP, UP, RIGHT, LEFT, DOWN. If the IR remote is unlocked, you can also unlock the keypad by using the IR remote to go to **Main Menu > Advanced Settings > System Settings** and uncheck **Keypad Lock**.

To unlock the IR remote, press the following keys on the IR remote in the order listed: UP, UP, RIGHT, LEFT, DOWN. If the keypad is unlocked, you can also unlock the IR remote by using the keypad to go to **Main Menu > Advanced Settings > System Settings** and uncheck **IR Remote Lock**.

Turning the Display On

- 1 Insert the power cord in to the display and into the power outlet.
- 2 Ensure the AC switch is set to “—”.
- 3 Press the ON button on the remote or the power button on the keypad.
- 4 The Planar splash screen should appear within about 15 seconds.

Note: If the Power Saving Mode is enabled and no digital input is connected, the display will wait for the delay specified in the Power section of the OSD and turn the display off. This will occur until a digital input is established. See the “Power Submenu” section on page 40 for more details.

Turning the Display Off

With the power on, press the OFF button on the remote or the power button the keypad to put the Planar LookThru LO55 in a standby mode. To turn power off completely, turn the AC switch to “o” or disconnect the AC power cord from the power outlet.

LED Indicators

The LED indicator light is visible under the perforated cover for the Electronics Box, near the right angle corner. The approximate location is identified by the circle in the figure on the right.

The table below indicates what the different LED Indicator colors and blink pattern mean.

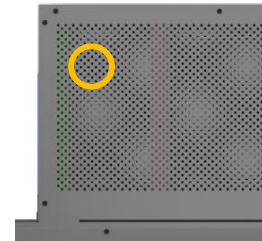

LED On

Power Status	Condition
Green	Standby mode
Amber	Full power mode
Green Flashing (1 Hz)	AC power on
Green Flashing (0.5 Hz)	Powering on from standby
Green Flashing (5 Hz)	Firmware updating
Amber Flashing (5 Hz)	Power supply failure
Green and Amber	Firmware update failure

Navigating Through the Menus

- 1 With the power on, press MENU. The MAIN menu appears.

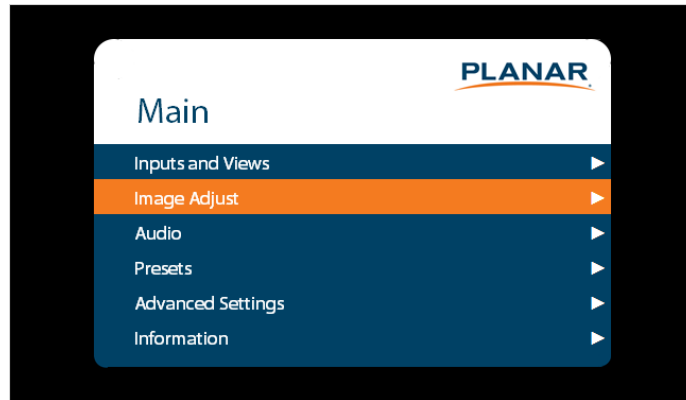

- 2 Within the menu, use ▲, ▼, ◀, ▶ and ENTER to navigate through the menus and adjust options.
- 3 Press PREV on the remote control, or MENU on the keypad, to return to the previous menu. To exit the menu system, press MENU on the remote control, or continue to press MENU on the keypad until the main menu is reached.

Inputs and Views Menu

This menu shows how the sources will be laid out on the screen based on the current Multi-Source View and Advanced Layouts selections.

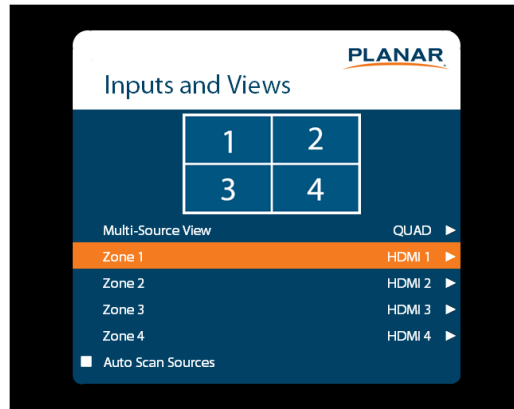

Multi-Source View

Select the Multi-Source View mode

Options: Single, Dual, Triple, Quad, PIP; **Default:** Single

Note: For the Advanced Layouts submenu, refer to page 32.

Note: You can only use 4K/60Hz in Single mode.

Zone 1

Select the source displayed in Zone 1

Options: HDMI 1, HDMI 2, HDMI 3, HDMI 4, DP; **Default:** HDMI 1

Zone 2

Select the source displayed in Zone 2

Options: HDMI 1, HDMI 2, HDMI 3, HDMI 4, DP; **Default:** HDMI 2

Zone 3

Select the source displayed in Zone 3

Options: HDMI 1, HDMI 2, HDMI 3, HDMI 4, DP; **Default:** HDMI 3

Zone 4

Select the source displayed in Zone 4

Options: HDMI 1, HDMI 2, HDMI 3, HDMI 4, DP; **Default:** HDMI 4

Auto Scan Sources

Select whether the display will automatically scan for a valid source on any zone that currently does not have a source

Options: On, Off; **Default:** Off

Advanced Layouts Submenu

This submenu defines the layouts for each multi-source view type.

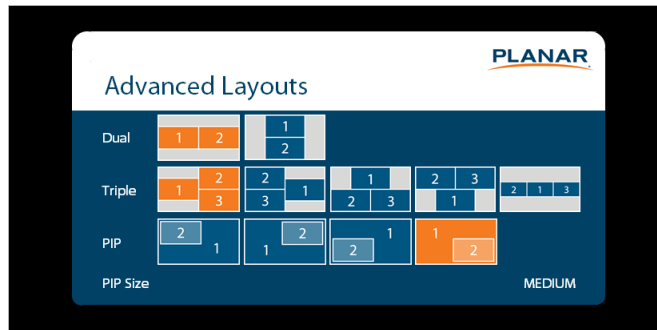

Dual

Select from two dual source layout options. The layout in orange will be the active layout displayed when the Multi-Source View is set to Dual.

Triple

Select from five triple source layout options. The layout in orange will be the active layout displayed when the Multi-Source View is set to Triple.

PIP

Select from four PiP (Picture-in-Picture) layouts. The layout in orange will be the active layout displayed when the Multi-Source View is set to PiP.

PIP Size

Select the size of the PiP (Picture-in-Picture) window.

Image Adjust Menu

This menu is used for making common image adjustments for the current zone.

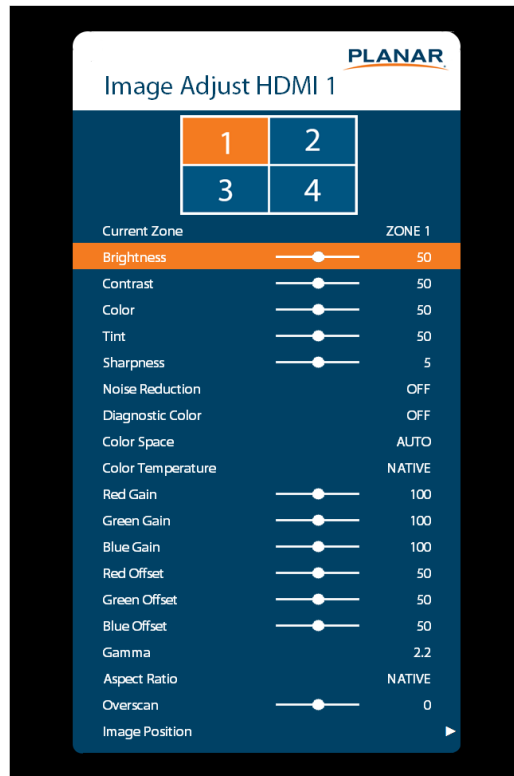

Current Zone

The zone that is currently being adjusted. All of the settings in this menu are saved per input. The zone's corresponding input source is shown in the title bar, and the graphic beneath that shows which zone is being adjusted in the current Multi-Source View mode and Advanced Layout setting (if applicable).

The current zone can be changed via the menu or by using the ZONE 1-4 keys on the remote control.

Note: Changing the Current Zone setting also changes the Audio Select setting.

Brightness

Adjust the brightness value of the image

Range: 0~100; Default: 50

Contrast

Adjust the contrast of the image
Range: 0~100; **Default:** 50

Color

Adjust the saturation of the image
Range: 0~100; **Default:** 50

Tint

Adjust the hue of the image
Range: 0~100; **Default:** 50

Sharpness

Adjust the sharpness of the image. Higher numbers are sharper
Range: 0~10; **Default:** 5

Noise Reduction

Turn on noise reduction processing
Options: Off, Low, Medium, High; **Default:** Off

Diagnostic Color

Set the image to monochrome. This setting is for use in adjustments to a test pattern and is not stored.
Options: Off, Red, Green, Blue; **Default:** Off

Color Space

Set the color space of the image
Options: REC601, REC709, RGB, RGB Video, Auto; **Default:** Auto

Color Temperature

Set the color temperature of the image
Options: 3200K, 5500K, 6500K, 7500K, 9300K, Native; **Default:** Native

Red Gain

Adjust the red gain of the image
Range: 0~200; **Default:** 100

Green Gain

Adjust the green gain of the image
Range: 0~200; **Default:** 100

Blue Gain

Adjust the blue gain of the image
Range: 0~200; **Default:** 100

Red Offset

Adjust the red offset of the image
Range: 0~100; **Default:** 50

Green Offset

Adjust the green offset of the image
Range: 0~100; **Default:** 50

Blue Offset

Adjust the blue offset of the image
Range: 0~100; **Default:** 50

Gamma

Set the gamma of the image
Options: 1.5, 1.55, 1.6, 1.65, 1.7, 1.75, 1.8, 1.85, 1.9, 1.95, 2.0, 2.05, 2.1, 2.15, 2.2, 2.25, 2.3, 2.4, 2.45, 2.5, 2.55, 2.6, 2.65, 2.7, 2.75, 2.8
Default: 2.2

Aspect Ratio

Set how the source is treated when the aspect ratio of the input is different than the aspect ratio of the zone it is in. If the image does not fill the zone completely, the extra margins are black.
Options: Auto, 16:9, 4:3, Fill Screen, Native, Letterbox; **Default:** Auto

Overscan

Set the percentage of the image to remove from each edge
Range: 0~20; **Default:** 0

Image Position

Move the image horizontally or vertically. The amount to move is measured in input pixels.
Range: -1000~1000; **Default:** 0

Audio Menu

This menu enables you to make audio adjustments to the selected zone.



Audio Select

The zone that is currently being adjusted and whose audio is being played. All of the settings in this menu are saved per input. The zone's corresponding input source is shown in the title bar.

Options: Zone 1, Zone 2, Zone 3, Zone 4; **Default:** Zone 1

Note: Changing the Audio Select setting also changes the Current Zone setting.

Volume

Set the volume of the audio

Range: 0~100; **Default:** 50

Balance

Set the audio balance

Range: 0~100; **Default:** 50

Mute

Mute or unmute the audio

Options: On or Off; **Default:** Off

Presets Menu

This menu enables you to save Inputs and Views settings, Image Adjust settings, Audio settings, the Backlight Intensity setting, and the Local Dimming setting. You can save up to 10 presets using this menu (more can be saved via the serial command interface). If a preset is saved, it will appear as "Preset 1", "Preset 2", and so on. If it is not saved, it will appear as "<Empty>".



Recall

Apply the setup from the selected preset
Range: Preset 1~Preset 10

Save

Save the current setup for later recall
Range: Preset 1~Preset 10

Delete

Delete the selected preset
Range: Preset 1~Preset 10

Advanced Settings Menu

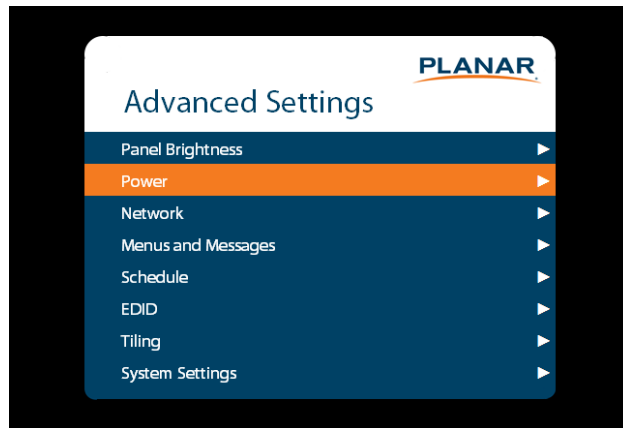

Panel Brightness Submenu



Intensity

Adjusts relative brightness of the panel
Range: 0 to 100%

Power Submenu

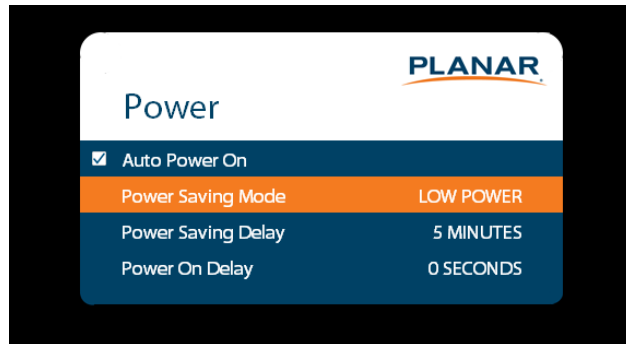

Auto Power On

Set whether the system will automatically leave standby mode after AC power is applied

Options: On, Off; **Default:** Off

Power Saving Mode

Set the action to take if there is no signal detected after the period of time selected by the Power Saving Delay setting:

Disabled: The display will remain on even if no signal is present.

Low Power: The display will enter standby mode if no signal is detected after the specified period of time.

Wake on Signal: The display will enter a reduced power mode if no signal is detected after the specified period of time. When in this state, the display will turn on when a signal is detected or when any key is pressed on the keypad or IR remote.

Power Saving Delay

Set the number of minutes to delay before initiating the power saving mode action (if any)

Options: 1 Minute, 5 Minutes, 15 Minutes, 30 Minutes, 60 Minutes; **Default:** 5 minutes

Power On Delay

Postpones startup by the set amount

Range: 0 to 10 seconds in 0.1 second increments

Network Submenu

The default static IP values are:

- IP Address: 192.168.12.12
- Subnet Mask: 255.255.255.0
- Default Gateway: 192.168.12.1

The static IP settings that you program will be used if a DHCP server cannot be found.

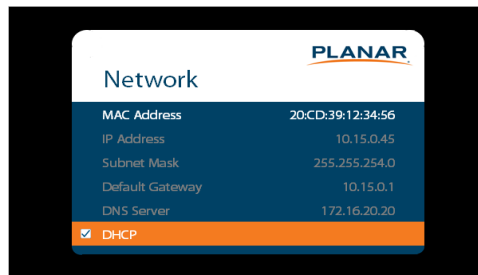

MAC Address

The MAC address of the system

IP Address

The current network address. You can use the number keys on the remote to enter this information.

Subnet Mask

The current subnet mask. You can use the number keys on the remote to enter this information.

Default Gateway

The current default gateway. You can use the number keys on the remote to enter this information.

DNS Server

The current DNS server. You can use the number keys on the remote to enter this information.

Note: The specified DNS server is used when Use Network Time is checked for the Set Date and Time setting.

DHCP

Turn DHCP on or off
Options: On, Off; Default: On

Menus and Messages Submenu

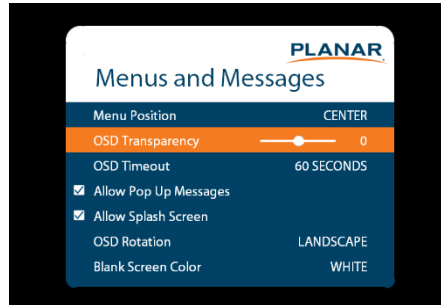

Menu Position

Move the OSD menu to a different location on the screen
Options: Center, Upper Left, Upper Right, Lower Left, Lower Right; **Default:** Center

OSD Transparency

Set the transparency of the OSD so that the image behind it can be seen. Higher values mean greater transparency.
Range: 0~5; **Default:** 0

OSD Timeout

Set the amount of time in seconds since the last keypress before the OSD menu automatically closes. If set to Off, the menu never automatically closes.
Options: Off, 10 Seconds, 30 Seconds, 60 Seconds, 120 Seconds, 240 Seconds;
Default: 60 Seconds

Allow Pop Up Messages

Suppress messages that pop up automatically. When set to No, the source status message and the volume slider bar will not be displayed.
Options: Yes or No; **Default:** Yes

Allow Splash Screen

Enable or disable the splash screen during startup

Options: Enable or Disable; **Default:** Enable

OSD Rotation

Rotate the OSD menu so that it is readable if the display is mounted in portrait orientation

Options: Landscape or Portrait; **Default:** Landscape

Blank Screen Color

Select the color to display when there is no signal in a zone

Options: Black, White, Gray, Red, Green, Blue, Cyan, Magenta, Yellow

Default: White

Schedule Submenu





Set Date and Time

Set the internal system clock. If **Use Network Time** is unchecked, you can set the following settings individually: Time Zone, Year, Month, Day, Date, Hour, and Minute.

Note: If Use Network Time is checked and DHCP is unchecked, the display will be unable to obtain the network time unless a DNS server is programmed. This is done via the DNS Server setting in the Network menu or the serial command interface.

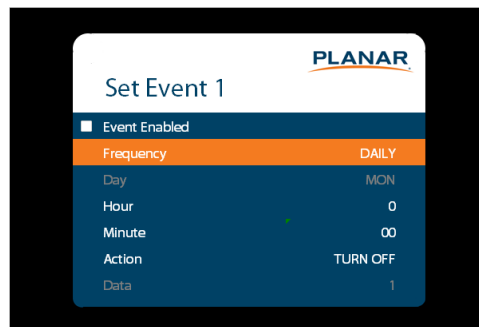

Set Event 1~Event 20

Event Enabled: Turns on the event. If disabled, the settings are saved so that the event can be re-enabled.

Frequency: The frequency of the event. Options are Daily, Weekly, Weekdays, Weekends.

Action: The action to take for the event. Options are Turn On, Turn Off, Recall, Backlight.

Data: The preset to recall when the Action is set to Recall, or the backlight setting when the Action is set to Backlight.

EDID Submenu

This menu specifies the EDID format and preferred timing for the selected connector.

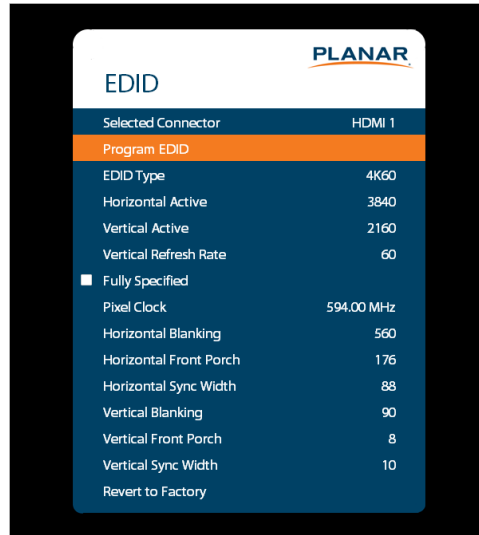

Selected Connector

Set which connector is used

Options: HDMI 1, HDMI 2, HDMI 3, HDMI 4, DP, OPS, All

Program EDID

Program the EDID information for the selected connector based on the selections in the EDID submenu

EDID Type

Set the EDID type to determine the base EDID used for the current connector:

4K60 selects an EDID format compliant with HDMI 2.0 and DP 1.2

4K30 selects an EDID format compliant with HDMI 1.4b and DP 1.1

1080P selects an EDID format compliant with HDMI 1.3 and DP 1.1

Options: 4K60, 4K30, 1080P

Horizontal Active

The number of active pixels in a line

Range: 0~4095

Vertical Active

The number of active lines in a field
Range: 0~4095

Vertical Refresh Rate

The number of fields per second rounded to the nearest Hz
Range: 0~120

Fully Specified

Determine how the final detailed timing is calculated. If disabled, it is calculated based on Horizontal Active, Vertical Active, and Vertical Refresh Rate values. If enabled, it is calculated based on all of the EDID values except for Vertical Refresh Rate.

Options: Disabled, Enabled

Note: This setting should only be enabled by advanced users.

Pixel Clock

The value of the pixel clock, in megahertz
Range: 0~60000

Horizontal Blanking

The number of non-active pixel clocks in a line
Range: 0~1023

Horizontal Front Porch

The number of pixel clocks in the horizontal front porch
Range: 0~1023

Horizontal Sync Width

The number of pixel clocks in the horizontal sync pulse
Range: 0~255

Vertical Blanking

The number of non-active lines in a field
Range: 0~255

Vertical Front Porch

The number of line times in the vertical front porch

Range: 0~255

Vertical Sync Width

The number of line times in the vertical sync

Range: 0~255

Revert to Factory

Reset the EDID type and timings to the default values for the selected connector

Tiling

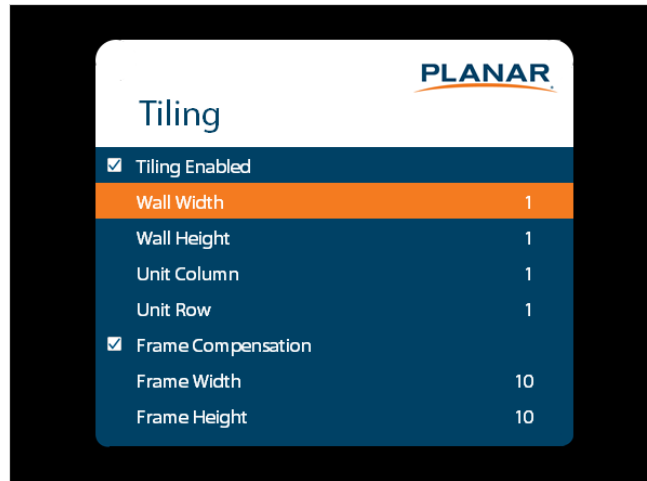

Tiling Enabled

Turns tiling on or off

Wall Width

Indicates the number of displays in the horizontal

Wall Height

Defines the number of displays in the vertical

Unit Column

Defines the horizontal address of the display within the titled wall

Unit Row

Defines the vertical address of the display within the tiled wall

Frame Compensation

Turns frame compensation on or off

Frame Width

Defines the amount of frame compensation on the left and right side of the content

Frame Height

Defines the amount of frame compensation on the top and bottom of the content

Comments about Frame Compensation

When video displays are used in an array, the intent is to display a large version of an image. However, even the tiniest of mullions can break up the image oddly. Notice the eagle's eye here.

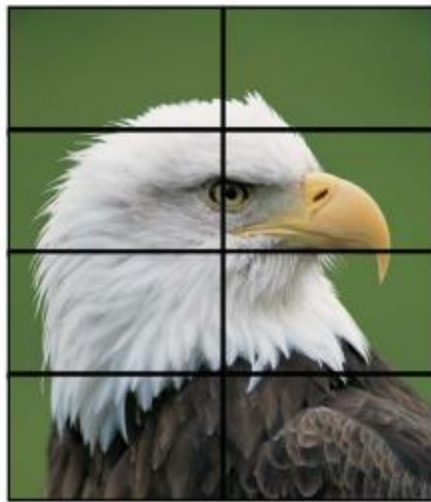

One way around this is to adjust the image spacing between displays. Imagine looking out a window made up of many panes of glass. The image you see is partially obscured by the frames (mullions), but your visual system assembles the image and ignores the bars.

Note: Frame compensation is also known as mullion or bezel compensation.

System Settings Submenu

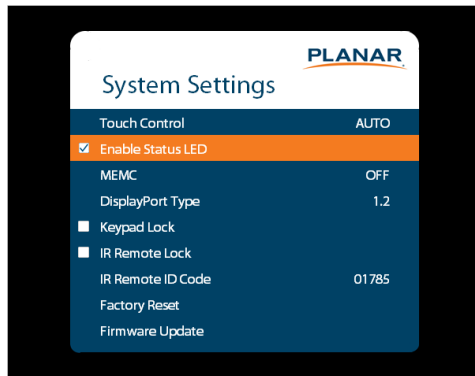

Enable Status LED

Turns on status LEDs

Pixel Orbit

Turns on pixel orbit. This moves the entire screen randomly by up to 10 pixels to lessen the onset of burn in.

Inverted Mount

Rotates the OSD when an inverted mount is used

IR Remote Code

Identifies the remote code address used. Refer to the *IR Command Protocol* section

DisplayPort Type

Set the version of DisplayPort that is used by the system

Options: 1.1, 1.2; **Default:** 1.2

Keypad Lock

Lock or unlock the keypad. When it is enabled, all keypad presses will be ignored.

Options: Enable, Disable; **Default:** Disable

IR Remote Lock

Lock or unlock the remote control. When it is enabled, all remote control presses will be ignored.

Options: Enable, Disable; **Default:** Disable

Factory Reset

Return the saved settings in a system to their factory defaults

Firmware Update

Update the firmware for the display. Refer to the instructions on the firmware release package for more information.

Information Menu



System Information Submenu

This menu displays version information for all programmable parts in the system. It also contains the model and serial number.

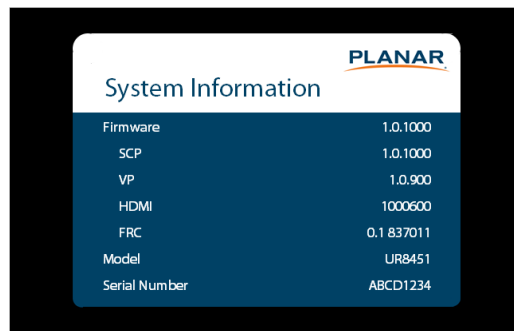
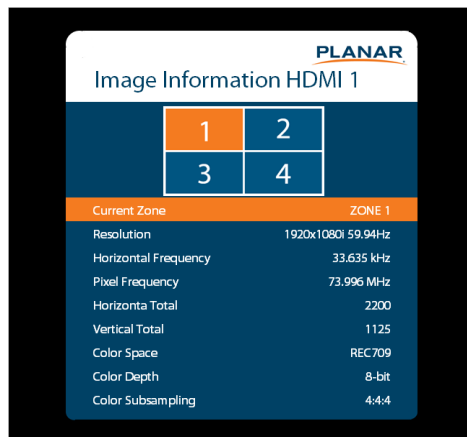

Image Information Submenu

This menu displays image details for the current zone. If more than one zone is available, you can change zones by setting the **Current Zone** option.



Error Log Submenu

This menu displays a chronological list of system errors that have occurred.

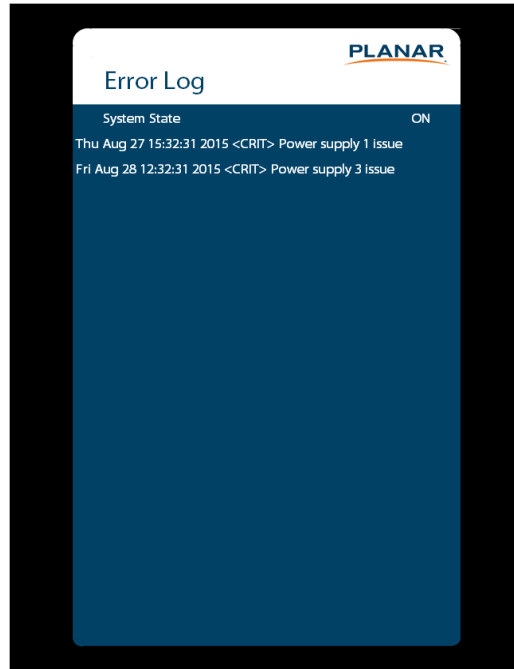

Using the Touch Screen (Planar LookThru L055-T and L055-ST Models)

You can use the touch screen to control your Windows, Mac, or Linux operating system. The Planar LookThru Series is HID compliant, delivering up to 12 points of touch on both Windows and Linux without a driver. To achieve greater than 12 points of touch on a Planar LookThru display, a driver will need to be installed on the operating system. Drivers for Window and Linux can be found on <http://www.planar.com/support> and on the USB flash driver included with the display. Single touch only is supported for Mac operating systems. There is no driver required to enable Mac support.

Developing Content

We strongly recommend you make use of the Planar LookThru OLED Transparent Display Content Developer's Guide at <http://www.planar.com/products/transparent-displays/oled/>. Use of this guide will both enhance the viewing experience of your Planar LookThru LO55 users and maximize the life of the display.

Signal Compatibility

Signal Type	Resolution	Frame rate (Hz)	Line Rate (kHz)	Pixel Rate (MHz)	HDMI 1-2	HDMI 3-4 + OPS	DisplayPort	References
PC	640x480	59.94	31.469	25.175	x	x	x	VESA DMT, CEA-861-F Format 1
	640x480	72	37.861	31.500	x	x	x	VESA DMT
	640x480	74.99	37.500	31.500	x	x	x	VESA DMT
	640x480	85	43.269	36.000	x	x	x	VESA DMT
	800x600	60.32	37.890	40.000	x	x	x	VESA DMT
	800x600	72	48.077	50.000	x	x	x	VESA DMT
	800x600	75	46.875	49.500	x	x	x	VESA DMT
	800x600	85.06	53.674	56.250	x	x	x	VESA DMT
	848x480	59.659	29.830	31.500	x	x	x	VESA CVT
	848x480	74.769	37.684	41.000	x	x	x	VESA CVT
	848x480	84.751	42.969	46.750	x	x	x	VESA CVT
	1024x768	60	48.363	65.000	x	x	x	VESA DMT
	1024x768	70	56.476	75.000	x	x	x	VESA DMT
	1024x768	75.03	60.023	78.750	x	x	x	VESA DMT
	1024x768	85.03	68.677	94.500	x	x	x	VESA DMT
	1152x864	70.012	63.851	94.500	x	x	x	VESA DMT
	1152x864	75	67.500	108.000	x	x	x	VESA DMT
	1152x864	84.999	77.094	121.500	x	x	x	VESA DMT
	1280x768	49.929	39.593	65.250	x	x	x	VESA CVT

Signal Type	Resolution	Frame rate (Hz)	Line Rate (kHz)	Pixel Rate (MHz)	HDMI 1-2	HDMI 3-4 + OPS	DisplayPort	References
PC	1280x768	59.995	47.396	68.250	x	x	x	VESA CVT-R
	1280x768	60	47.776	79.500	x	x	x	VESA CVT
	1280x768	74.893	60.289	102.250	x	x	x	VESA CVT
	1280x768	84.837	68.633	117.500	x	x	x	VESA CVT
	1280x960	60	60.000	108.000	x	x	x	VESA DMT
	1280x960	75	75.000	126.000	x	x	x	VESA DMT
	1280x960	85.002	85.938	148.500	x	x	x	VESA DMT
	1280x1024	60.02	63.981	108.000	x	x	x	VESA DMT
	1280x1024	75.02	79.976	135.000	x	x	x	VESA DMT
	1280x1024	85.02	91.146	157.500	x	x	x	VESA DMT
	1360x768	60	47.712	85.500	x	x	x	VESA DMT
	1400x1050	49.965	54.113	100.000	x	x	x	VESA CVT
	1400x1050	60	64.7	101.00	x	x	x	VESA CVT-R
	1400x1050	60	65.317	121.750	x	x	x	VESA CVT
	1400x1050	74.867	82.278	156.000	x	x	x	VESA CVT
	1600x1200	60	75.000	162.000	x	x	x	VESA DMT
	1920x1080	49.929	55.621	141.500	x	x	x	VESA CVT
	1920x1080	59.963	67.158	173.000	x	x	x	VESA CVT
	1920x1080	59.950	66.587	138.500	x	x	x	VESA CVT-R
	1920x1200	49.932	61.816	158.250	x	x	x	VESA CVT
1920x1200	59.950	74.038	154.000	x	x	x	VESA CVT-R	

Signal Type	Resolution	Frame rate (Hz)	Line Rate (kHz)	Pixel Rate (MHz)	HDMI 1-2	HDMI 3-4 + OPS	DisplayPort	References
PC	1680x1050	49.974	54.121	119.500	x	x	x	VESA CVT
	1680x1050	59.954	65.290	146.250	x	x	x	VESA CVT
	1920x2160	60	135.000	297.000	x	x	x	CEA-861-F, VIC 16, with vertical parameters doubled
	2560x1440	59.951	88.787	241.500	x	x	x	VESA CVT-R
	2560x1600	59.972	98.713	268.500	x	x	x	VESA CVT-R
	3840x2160	24	52.438	209.750	x	x	x	VESA CVT-R
	3840x2160	30	65.688	262.750	x	x	x	VESA CVT-R
	3840x2160	50	110.500	442.000	x		x	VESA CVT-R
	3840x2160	60	133.313	533.250	x		x	VESA CVT-R
Apple Mac	640x480	66.59			x	x	x	
	832x624	75.087	49.107	55.000	x	x	x	
	1024x768	59.278	48.193	64.000	x	x	x	
	1024x768	74.927	60.241	80.000	x	x	x	
	1152x870	75.062	68.681	100.000	x	x	x	
SDTV	480i	60			x	x	x	SMPTE 125M, CEA-861-F Formats 6 & 7
	576i	50			x	x	x	ITU-R BT.601, CEA-861-F Formats 21 & 22
EDTV	480p	60	31.469	27.000	x	x	x	ITU-R BT.1358, CEA-861-F Format 17 & 18
	576p	50	31.250	27.000	x	x	x	SMPTE 125M, CEA-861-F Format 6 & 7
HDTV	1080i	50	28.125	74.500	x	x	x	SMPTE 274M, CEA-861-F Format 20

Signal Type	Resolution	Frame rate (Hz)	Line Rate (kHz)	Pixel Rate (MHz)	HDMI 1-2	HDMI 3-4 + OPS	DisplayPort	References
HDTV	1080i	60	33.750	74.250	x	x	x	SMPTE 274M, CEA-861-F Format 5
	720p	50	37.500	74.250	x	x	x	SMPTE 296M, CEA-861-F Format 19
	720p	60	45.000	74.250	x	x	x	SMPTE 296M, CEA-861-F Format 4
	1080p	24	27.000	74.250	x	x	x	SMPTE 274M, CEA-861-F Format 32
	1080p	25	28.125	74.250	x	x	x	SMPTE 274M, CEA-861-F Format 33
	1080p	30	33.750	74.250	x	x	x	SMPTE 274M, CEA-861-F Format 34
	1080p	50	56.250	148.500	x	x	x	SMPTE 274M, CEA-861-F Format 31
	1080p	60	67.500	148.500	x	x	x	SMPTE 274M, CEA-861-F Format 16
UHDTV	3840x2160	24	54.000	297.000	x	x	x	CEA-861-F Format 93, HDMI 1.4b VIC 1
	3840x2160	25	56.250	297.000	x	x	x	CEA-861-F Format 94, HDMI 1.4b VIC 2
	3840x2160	30	67.500	297.000	x	x	x	CEA-861-F Format 95, HDMI 1.4b VIC 3
	3840x2160	50	67.500	297.000	x			CEA-861-F Format 96, 4:2:0 sub-sampling
	3840x2160	50	135.000	594.000	x		x	CEA-861-F Format 96
	3840x2160	60	67.500	297.000	x			CEA-861-F Format 97, 4:2:0 sub-sampling
	3840x2160	60	135.000	594.000	x		x	CEA-861-F Format 97

Troubleshooting

When the power switch is toggled from the “o” switch position (power off) to the “-” switch position (power on), you should immediately hear the sound of relay “click” and see blue and green LED illuminate through the perforated cover on the Electronics Box (when viewed from above). After less than 20 seconds you should see a Planar Logo splash screen for a few seconds. If a live video source is connected and enabled, the image from the video will be visible directly after the splash screen. A Sources Status window from the OSD will also be visible for a few seconds. If there is no live video source connected, the default screen color will be shown (refer to the **Blank Screen Color** option in the “Menus and Messages Submenu” section on page 42).

You can also refer to the “LED Indicators” section on page 29 for information on how to monitor the real-time status of the video board.

Possible Problem: The power switch is toggled and nothing happens.

Items to check:

- Make sure the AC power cable is securely connected at both ends and that AC power is available.
- There are two fuses in the AC power receptacle. These are 5A, 250V, 5 x 20mm, FST fuses. Have a qualified technician check these fuses.

Possible Problem: The monitor powers on and shows the splash screen but afterwards remains in the default screen color.

Items to check:

- Refer to the Inputs and Views Menu (see page 31) and select the video port that is connected to the video source you want.

If these troubleshooting instructions do not resolve the problem, please contact Planar’s Technical Support team (<http://www.planar.com/support/products/transparent-displays/>) to determine the next steps.

US and Canada

Phone: +1-866-PLANAR1 ([1-866-752-6271](tel:1-866-752-6271)) or ([503-748-5799](tel:503-748-5799))

Europe, Middle East and Africa

Phone: [+33 5 63 78 38 10](tel:+33563783810)

Asia, Pacific and Latin America

Phone: [+1-503-748-5799](tel:+1-503-748-5799)

Maintenance

Cleaning the Display

Metal Surfaces

- These can be wiped with an absorbent towel. Do not allow any liquid to get into the Electronics Box.
- Check the perforated metal of the Electronics Box periodically for accumulated dust. Use a vacuum cleaner to remove the accumulation.

Cleaning Front AR Glass

Antireflective coatings can be difficult to clean to perfection. We recommend the following:

- Use a soft, lint-free towel or paper. Premium cheesecloth works well.
- Use quality glass cleaner suitable for LCD screens. A premium grade of isopropyl alcohol (IPA) can also be used, either by itself or as a supplement to the glass cleaner. Use the IPA separately from the glass cleaner, i.e. don't mix them. Ideally use different towels for each liquid.

Note: IPA is flammable. DO NOT USE IPA NEAR AN OPEN FLAME OR OTHER IGNITION SOURCE.

- DO NOT allow either the glass cleaning solution or IPA to enter the Electronics Box or the gap between the backside of the Display Glass and the Display Chassis.
- Apply the cleaning liquid, glass cleaner or IPA, sparingly to the towel (as opposed to the glass surface) and start at one side of the screen. Use circular motion and work your way across the screen. You should see the glass cleaner evaporate to a clean, streak-free surface. Some suggestions include:
 - Avoid coming in contact with the exposed perimeter found on the LO55 and LO55-S. Contact with the silicone edge seal may result in introducing a silicone residue onto the AR coating. This will complicate the cleaning process.
 - If you're not seeing a streak-free surface, increase the amount of cleaner applied to the cloth and replace the towels more often.

Cleaning the Backside of the Display Glass

Use the same materials described above. Again, avoid making contact with the perimeter silicone seal and don't allow any liquid into the gap between the backside of the Display Glass and the Display Chassis. There is no AR coating on the backside of the Display Glass.

Specifications

Specification Item	LO55 Standard	LO55-S Straightmount	LO55-T Standard with Touch	LO55-ST Straightmount with Touch
AMOLED Panel				
Resolution	1920 x 1080			
Aspect Ratio	16 x 9			
Screen Size	55"			
Pixel Pitch	0.64mm			
Viewing Angle	±89°			
Color Gamut	100% NTSC			
# of Display Colors	1.07B (10 bits)			
Connectivity				
Standard Inputs	DisplayPort 1.2, HDMI2.0 x 2, HDMI 1.4x2			
Control and Monitoring	LAN RJ45, RS 232 In, IR, Keypad, Planar® UltraRes™ App			
Mechanical				
Display Dimensions, Inches (mm)	48.09 (1221) x 31.06 (789) x 11.8 (300)	48.09 (1221) x 40.52 (1029) x 5.19 (132)	49.39 (1255) x 31.64 (804) x 12.2 (309)	49.39 (1255) x 41.10 (1044) x 5.53 (141)
Display Weight lbs (kg)	74.0 (33.6)	66.6 (35.0)	86.7 (33.6)	89.8 (35.0)
Mounting	Five primary M6, five secondary M6			
Fanless	Yes			
Usage				
Recommended Usage	≤ 12 hours/day, moving image, 75 nits average luminance			
Luminous Life*	30,000 hours			
Power/Electrical				
Power Consumption, Max (White Screen)	145W	145W	150W	150W
Power Consumption, Typ. Video	100 – 130W	100 – 130W	105 – 135W	105 – 135W
Standby Power Consumption	<0.5W	<0.5W	<0.5W	<0.5W
Input Voltage/ Frequency	100 to 240V/50-60Hz			
AC Line Fuse Protection	5A, 250V, 5 x 20mm, FST			

Specifications

Specification Item	LO55 Standard	LO55-S Straightmount	LO55-T Standard with Touch	LO55-ST Straightmount with Touch
Front Glass				
Glass Treatment	ERO with Anti-reflection (AR) coating			
Glass Type	2x2mm Corning Gorilla Glass			
Touch				
Touch Technology	NA		IR	IR
Supporting OS	NA		Windows 7, 8, 10, Vista, XP, Mac OSX and Linux	
Detectable Touch Points	NA		32+	
Minimum Detectable Object	NA		1.5mm	
Touch Sample Rate	NA		Up to 250 fps	
Environmental				
Storage Temperature	-25° to 65° C			
Operating Temperature	0° to 40° C			
Storage Humidity	5 to 95% RH			
Operating Humidity	20 to 95% RH			
Regulatory Compliance	FCC Class A, cTUVus, CE			

* Time to 50% of initial brightness operating at 25 ° C with a moving image and 75 nits average luminance

Line Drawings

Note: 3D models are available at (<http://www.planar.com/products/transparent-displays/oled/>)

Standard Design

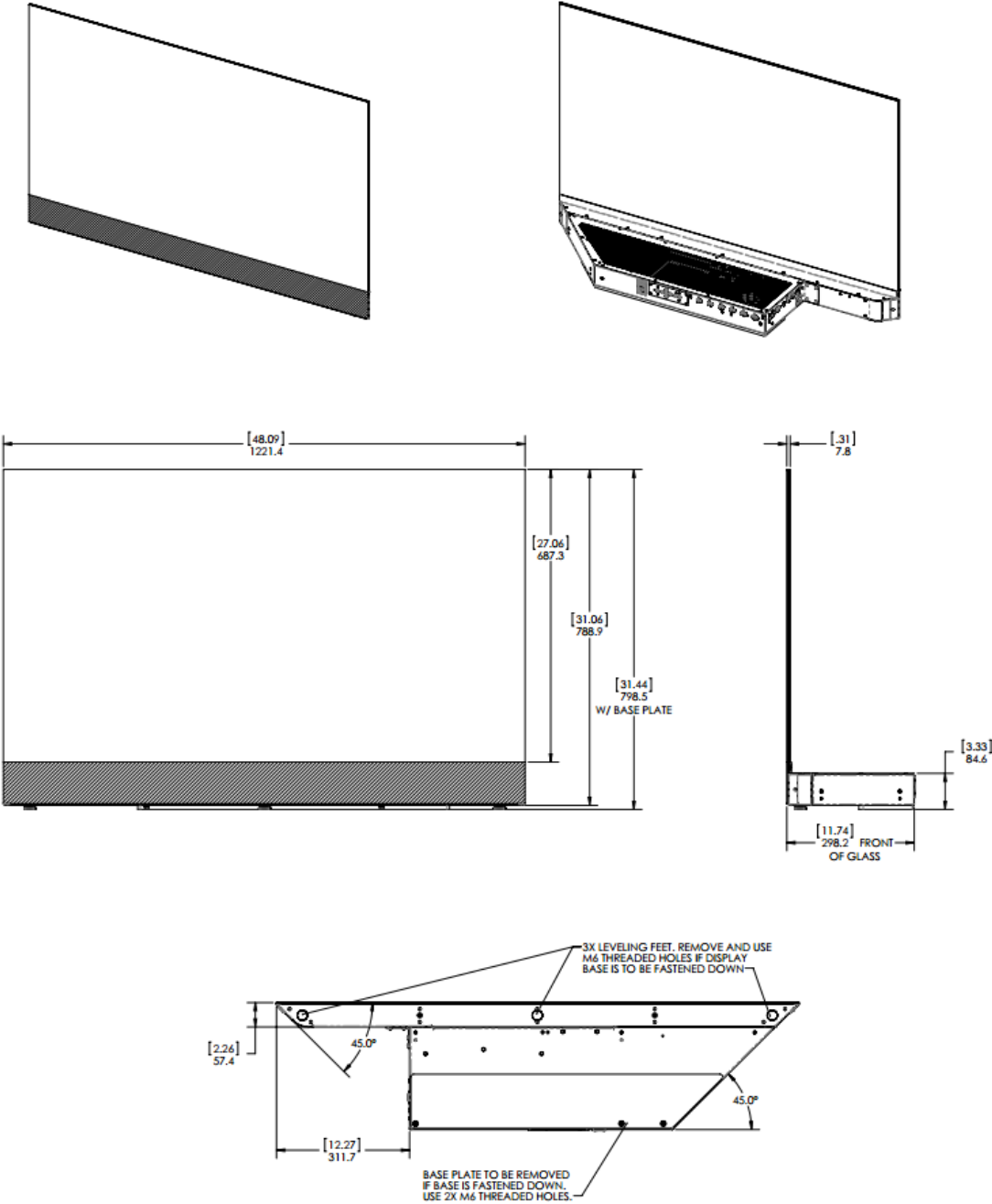

Standard Design with Touch

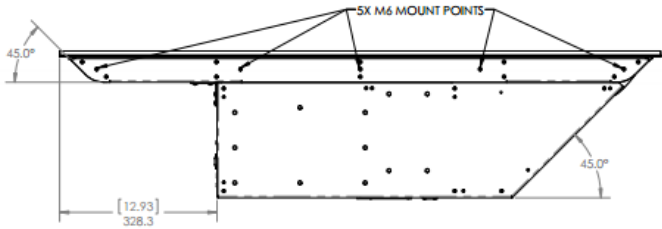
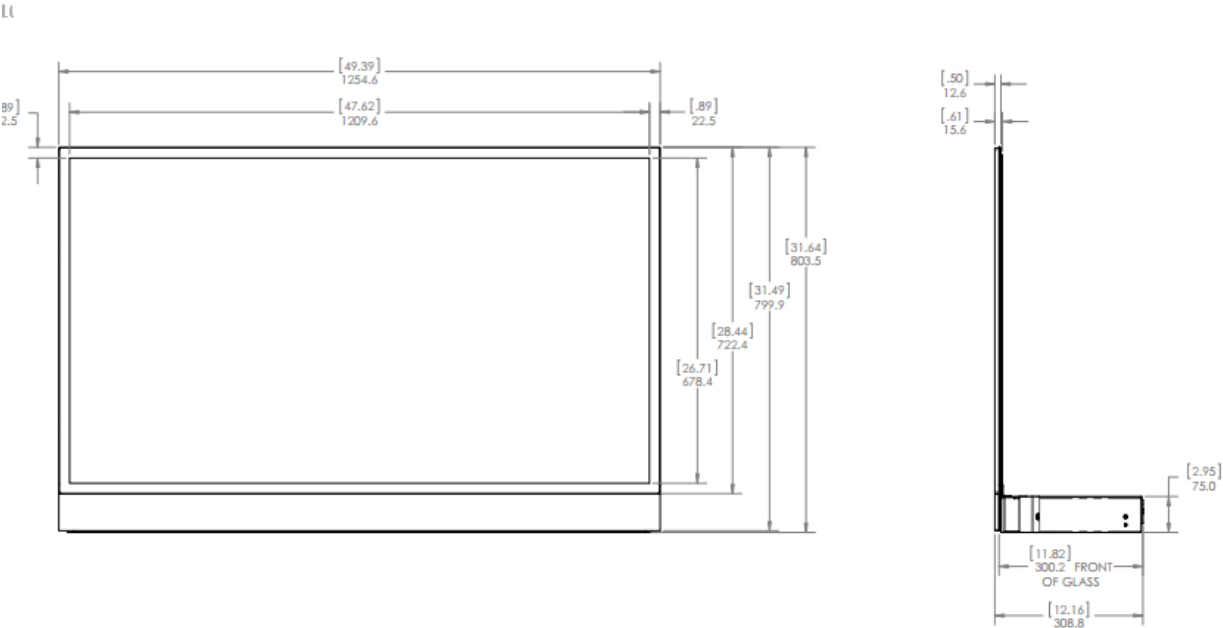
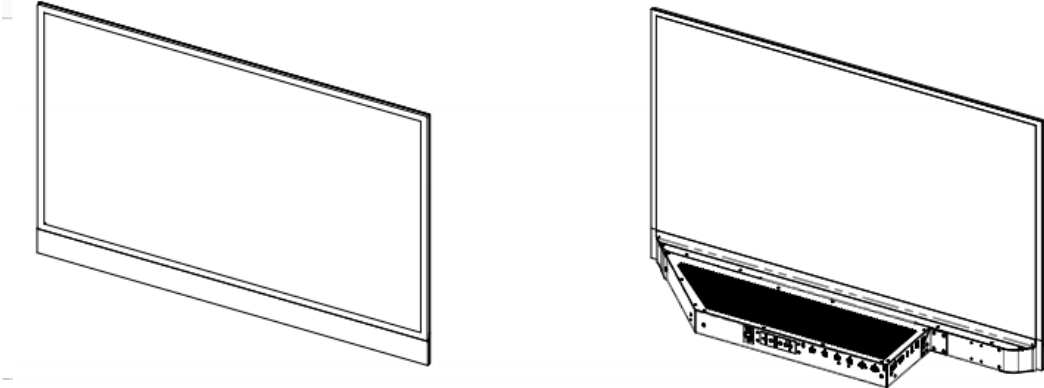

Straightmount Design with Touch

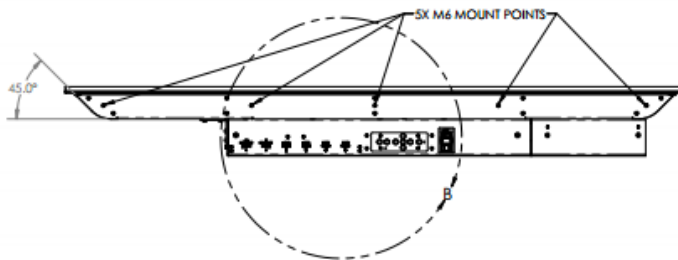
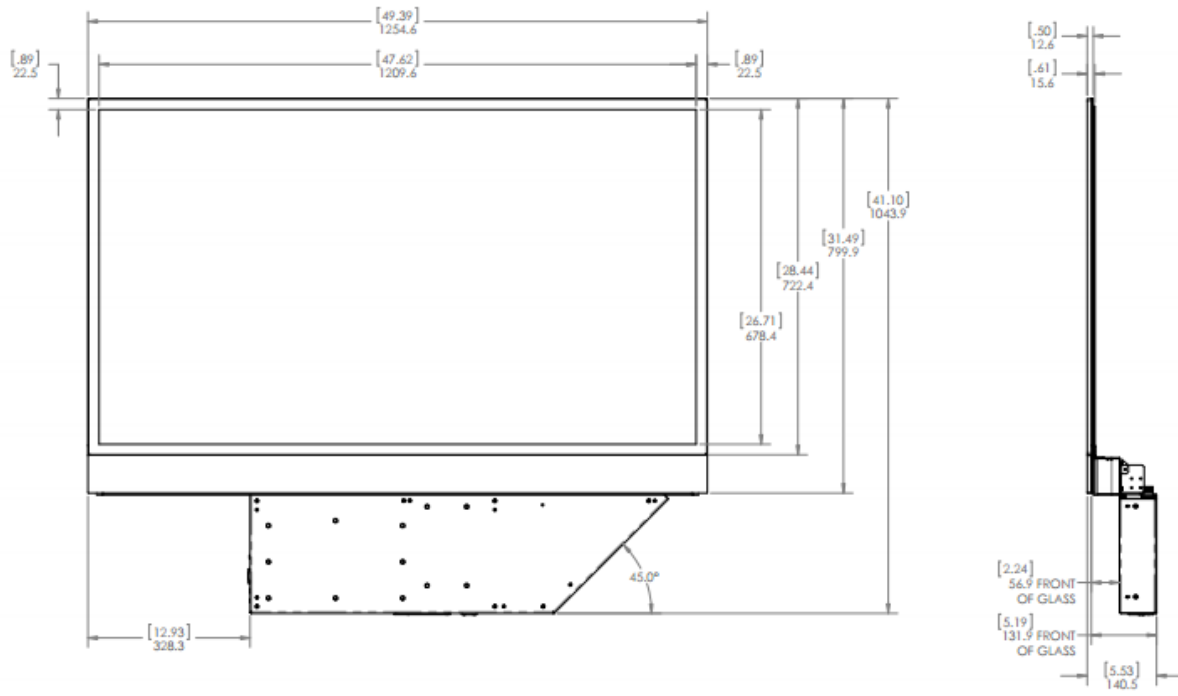
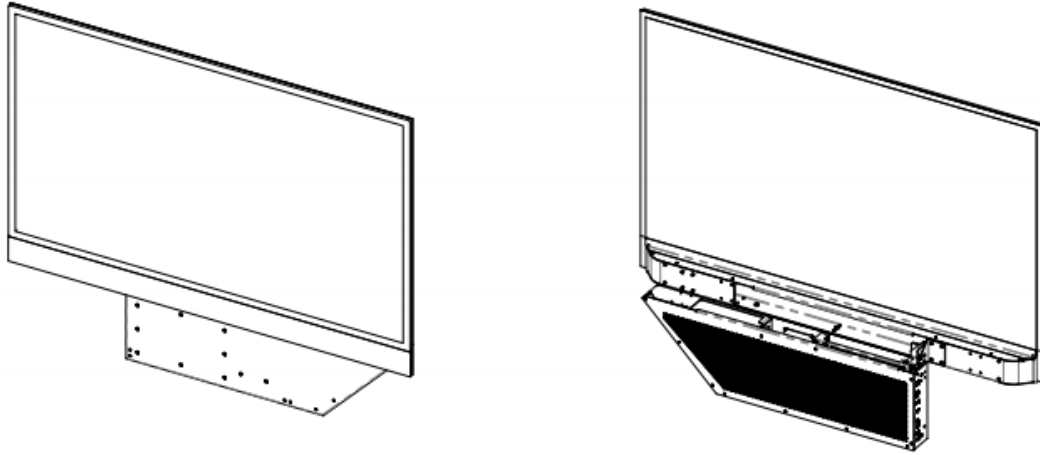

Accessing Planar's Technical Support Website

Visit <http://www.planar.com/support> for the following support documents and resources:

- User Manual
- RS232 User Manual
- Touch screen drivers
- Standard warranties
- Planar support hotline number and email

Visit <http://www.planar.com/products/transparent-displays/oled/> for the Planar LookThru Fabricator's Guide and the Planar LookThru Content Developer's Guide.

Regulatory Information

Manufacturer's Name: Planar Systems, Inc.

Manufacturer's Address: 1195 NW Compton Drive

Beaverton, OR 97006

Note: This equipment has been tested and found to comply with the limits for a Class A digital device, pursuant to part 15 of the FCC Rules. These limits are designed to provide reasonable protection against harmful interference when the equipment is operated in a commercial environment. This equipment generates, uses, and can radiate radio frequency energy and, if not installed and used in accordance with the instruction manual, may cause harmful interference to radio communications. Operation of this equipment in a residential area is likely to cause harmful interference in which case the user will be required to correct the interference at his own expense.

Industry Canada (ICES-003): This Class A digital apparatus complies with Canadian ICES-003.

Cet appareil numérique de la classe A est conforme à la norme NMB-003 du Canada.

Any changes or modifications to the display not expressly approved by Planar could void the user's authority to operate this equipment.

Other Certifications:

CISPR 22