

PS7050/PS7050T and PS8250/PS8250T User Guide



Copyright © 22 Jul 2015 by Planar Systems, Inc. All rights reserved.

Contents of this publication may not be reproduced in any form without permission of Planar Systems, Inc.

Trademark Credits

Windows™ is a trademark of Microsoft Corp.

All other names are trademarks or registered trademarks of their respective companies.

Disclaimer

The information contained in this document is subject to change without notice. Planar Systems, Inc. makes no warranty of any kind with regard to this material. While every precaution has been taken in the preparation of this manual, the Company shall not be liable for errors or omissions contained herein or for incidental or consequential damages in connection with the furnishing, performance, or use of this material.

Warranty and Service Plans

Planar warranty and service plans will help you maximize your investment by providing great support, display uptime, and performance optimization. From post-sale technical support to a full suite of depot services, our services are performed by trained Planar employees. When you purchase a Planar product, you get more than a display, you get the service and support you need to maximize your investment. To find the latest warranty and service information regarding your Planar product, please visit <http://www.planar.com/support>

RoHS Compliance Statement

The PS7050/PS7050T and PS8250/PS8250T are fully RoHS compliant.

Part Number: 020-1274-00C

Table of Contents

- PS7050/PS7050T and PS8250/PS8250T User Guide** i

- Introduction**7
 - Safety Information8
 - Important Safety Instructions8
 - Recommended Usage 10
 - Burn-In Versus Temporary Image Retention 10
 - VESA Mounts, General Description 11
 - Cleaning the Display 11

- Package Contents** 12
 - Unpacking the Display 12
 - Contents of the Accessory Kit 12

- Installing the Display** 13
 - Before You Begin 13
 - Tools/Equipment List 13
 - Other Things You May Need 13
 - Plan Your Installation 13
 - Prepare Your Installation Location 13
 - Signal Source Inputs 14

- Operating the Display** 15
 - OSD Keypad 15
 - Remote Control 16
 - Locking the Remote 18
 - IR Sensor and LED Indicators 18
 - Using the Display in Portrait Mode 18
 - Using the Display in Flat or Tilted Orientation 18

Turning the Display On.....	18
Turning the Display Off.....	19
Selecting the Input Source	19
OSD Menu Functions.....	20
Picture Menu.....	20
Sound Menu	21
Option Menu.....	22
Time Menu.....	23
Playing Media Files.....	24
Playing Videos	25
Media Menu Bar When Videos are Playing.....	26
Playing Image Files	27
Media Menu Bar When Image Slideshows are Playing.....	28
RS232 Communication	29
Connecting the RS232 Cable.....	29
RS232 Commands.....	29
Touch Screen Operation.....	32
Signal Compatibility.....	33
Specifications.....	35
Dimensions	36
PS7050 - Front and Side	36
PS7050 - Rear	36
PS7050T - Front and Side	37
PS7050T - Rear	37
PS8250 - Front and Side	38
PS8250 - Rear	38
PS8250T - Front and Side	39
PS8250T - Rear	39
Troubleshooting.....	40

Accessing Planar Technical Support 41

EMC (Electro Magnetic Compatibility) Certification 42

Introduction

The PS7050/PS7050T and the PS8250/PS8250T are 70" and 82" diagonal commercial-grade LCD displays.

The displays have a native full HD (1920 x 1080) resolution and an aspect ratio of 16:9.

All models are designed for up to 24x7 performance and come standard with a variety of commercial grade features.

The PS7050T and the PS8250T models also incorporate embedded interactive touch supporting up to 10 touch points and a wide range of operating systems.

Caution: This manual is intended for use by qualified service persons and end users with experience installing LCD displays.

Safety Information

This display was designed with safety in mind. If you don't heed the safety warnings and cautions, you could get hurt. The safety warnings are on stickers in various places in and on the display.

Important Safety Instructions

- 1** Read these instructions.
- 2** Keep these instructions.
- 3** Heed all warnings.
- 4** Follow all instructions.
- 5** Do not use any of the Planar LCD products near water.
- 6** Clean the LCD screens with an LCD screen cleaner or LCD wipes.
- 7** Do not install near any heat sources such as radiators, heat registers, stoves or other apparatus (including amplifiers) that produce heat.
- 8** Do not defeat the safety purpose of the polarized or grounding type plug. A polarized plug has two blades with one wider than the other. A grounding type plug has two blades and a third grounding prong. The wide blade or the third prong is provided for your safety. When the provided plug does not fit into your outlet, consult an electrician for the replacement of the obsolete outlet.
- 9** Protect the power cord from being walked on or pinched particularly at plugs, convenience receptacles and the point where they exit from any of the Planar LCD products.
- 10** Only use the attachments/accessories specified by the manufacturer.
- 11** Unplug all Planar LCD displays during lightning storms or when unused for long periods of time.
- 12** You must follow all National Electrical Code regulations. In addition, be aware of local codes and ordinances when installing your system.
- 13** Refer all servicing to qualified service personnel. Servicing is required when any of the displays have been damaged in any way. For example, if the AC power cord or plug is damaged, liquid has been spilled or objects have fallen into a display, the displays have been exposed to rain or moisture, do not operate normally or have been dropped.

- 14** Keep the packing material in case the equipment should ever need to be shipped.
- 15** Wall mounts must be secure. The wall must be strong enough to hold all displays, mounts, brackets and cables.
- 16** Slight pressure on the LCD will cause distortion of the image. Heavier pressure will cause permanent damage. Displays should be mounted in a way that viewers cannot insert small objects in the openings that will create hazards by contacting bare conductive parts.
- 17** The front polarizer is soft and subject to scratches from sharp objects. The polarizer is a thin sheet of film laminated to the outside layer of glass on the LCD screen. Take care when handling items near the screen.

Recommended Usage

In order to get the most out of your LCD, use the following recommended guidelines to optimize the display.

Burn-In Versus Temporary Image Retention

Burn-in causes the screen to retain an image essentially forever, with little or no way to correct the problem. Under normal use, an LCD will not experience burn-in, as plasma displays do, nor will it retain images in any way.

Normal use of an LCD is defined as displaying continuously changing video patterns or images. However, LCDs can experience temporary image retention when recommended usage guidelines are not followed.

What is Temporary Image Retention?

Temporary image retention (TIR) can occur when a static image is displayed continuously for extended periods of time (12 hours or longer). An electrical charge differential may build up between the electrodes of the liquid crystal, which causes a negative-color video image (color-inverted and brightness-inverted version of the previous image) to be retained when a new image is displayed. This behavior is true for any LCD device from any LCD manufacturer.

TIR is not covered under warranty. See standard warranty terms and conditions for details. Here are some guidelines to help you avoid TIR:

- Use the LCD to show a screen saver, moving images or still pictures that change regularly. When using high-contrast images, reposition the images frequently.
- Turn off the LCD when it is not in use. To use your source computer's Power Options Properties, set up your computer to turn off the display when not in use.

Caution: For optimal performance, we suggest turning off the backlight power on the display for six hours per day.

Normal Usage Guidelines

Normal use of the LCD is defined as operating in the open air to prevent heat buildup, and without direct or indirect heat sources such as lighting fixtures, heating ducts, or direct sunlight that can cause the modules to experience high operating temperatures. For all modules, do not block fans or ventilation openings. If the LCD module will be installed in a recessed area with an LCD surround or enclosure, ensure adequate openings are applied for proper air flow and ventilation.

At 2000 meters or below, the maximum ambient operating temperature for the LCD module cannot be above 50° C nor below the minimum ambient operating temperature of 0° C. If one of these conditions exists, it is up to the installer to ensure that placement is changed, thermal shielding is provided and/or additional ventilation is provided to keep the display within its nominal operating parameters.

Cooling Requirements

For optimal performance, active cooling by the installer should be planned for when the ambient temperature anywhere in the wall is predicted to be above the specified ambient temperature for the display.

VESA Mounts, General Description

VESA mounts are used to secure the PS7050/PS7050T and the PS8250/PS8250T for display. The displays can be installed using a variety of VESA mounts available through Planar. If you do not have a VESA mount and would like to purchase one, contact Planar.

If you purchased a VESA mount, you should have received a separate box with mounting supplies and an Installation manual. Follow these instructions carefully.

Keep in mind the following general installation guidelines:

- Screw length is crucial and will vary depending on the type of mount you use. Total screw length will include the penetration length plus the length required by the type of VESA mount in use.

Caution: Shorter screws will result in insufficient mounting strength and longer screws could puncture parts inside the display. Prior to installation, make sure you know where all of the mounting points are located. Follow all safety precautions outlined in the VESA Mount Installation manual.

Cleaning the Display

If dust has collected on the power plug, removed the plug from the outlet and clean off the dust. Dust build-up may cause a fire.

Remove the power plug before cleaning. Failure to do so may result in electrical shock or damage.

Keep the following points in mind when cleaning the surface of the display:

- When the surface of the display becomes dirty, wipe the surface lightly with a soft clean cloth.
- If the surface requires additional cleaning, use LCD screen cleaner or LCD wipes, which are available at most electronics stores.
- Do not let cleaner seep into the display, as it may cause electrical shock or damage.







Package Contents

Unpacking the Display

The display is packed in a cardboard box. The display is packed using foam to protect it during shipping. Before unpacking the display, prepare a stable, level and clean surface near a wall outlet.

Place the LCD panel box in an upright position. Remove the entire top of the box and the top shipping foam.

Contents of the Accessory Kit

Part	Picture	Quantity
Remote control with 2 batteries		1
Power cord, 1.8 meters		1
VGA cable (D-sub), 1.8 meters		1
Keypad cover and screws for mounting		1
Quick start guide		1
USB cable (A to B), 1.8 meters		1 (PS7050T and PS8250T only)

Installing the Display

This section explains how to install a display.

Before You Begin

Make sure you have all the items in these lists before you begin unpacking and installing your displays.

Tools/Equipment List

Depending on your installation, you may need one or more of the following items:

- String/string level
- Digital/laser level
- Ladders/lift
- Back brace
- Stud finder (if hanging display on a wall)

Other Things You May Need

- LCD screen cleaner or LCD wipes - available at most electronics stores
- At least two very strong people to help lift units into place

Plan Your Installation

You should have a detailed plan of how the units are to be configured. The plan should include calculations for the following:

- Power
- Cable runs
- Ventilation and cooling requirements
- If hanging display on a wall, location of studs in the wall

Prepare Your Installation Location

You should have prepared the area where you will install the unit. If custom enclosures are part of the installation, they must be fully designed to accommodate the installation of the displays, as well as the installed unit and ventilation and cooling requirements.

If your installation included a lot of construction or dust, it is highly recommended that you clean all of the screens after the wall installation and configuration are complete.

Signal Source Inputs

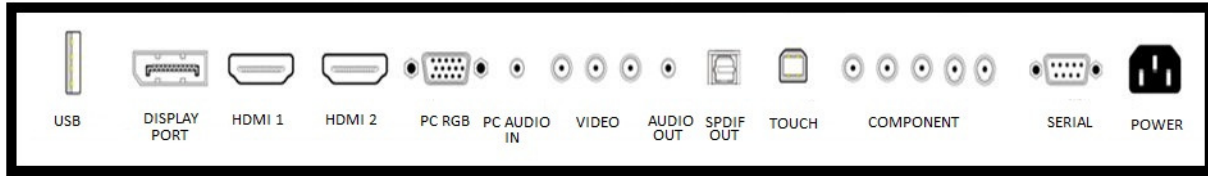

Label	Connector	Notes
USB	USB 2.0	USB playback and firmware updates
DisplayPort	DisplayPort	
HDMI 1	HDMI	
HDMI 2	HDMI	
PC RGB	D-Sub 15 pin	VGA
PC Audio In	3.5mm jack	
Video	RCA, RCA L/R	Composite video and audio
Audio Out	3.5mm jack	
SPDIF Out	TOSLINK jack	Optical audio
Touch	USB Type B	PS7050T and PS8250T only
Component	RCA G/B/R, RCA L/R	Video and audio
Serial	D-Sub 9 pin	RS-232
Power	AC power input	

Operating the Display

OSD Keypad

The OSD keypad is located on the bottom rear of the display.

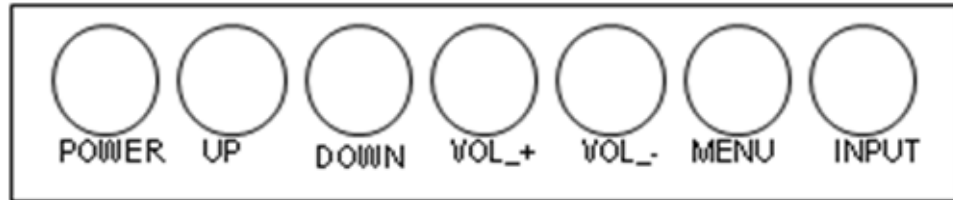

Key	Descriptions
POWER	Use this button for Power On / Off
UP	Move menu up / Change menu mode
DOWN	Move menu down
VOL +	Volume Up/ Move Menu Bottom / Menu Value Increase
VOL -	Volume Down / Move Menu Top / Menu Value Decrease
MENU	Menu Mode Active / Menu Mode Close / Move Top
INPUT	Select the input signal

To lock the keypad, press the “Down” and “Vol+” buttons together for 7 seconds. Repeat the process to unlock the keypad.

A cover is included in the accessory kit that can be attached with the included screws over the keys to prevent key presses.

Remote Control

Below is a picture of the remote control and a description of the functions supported.

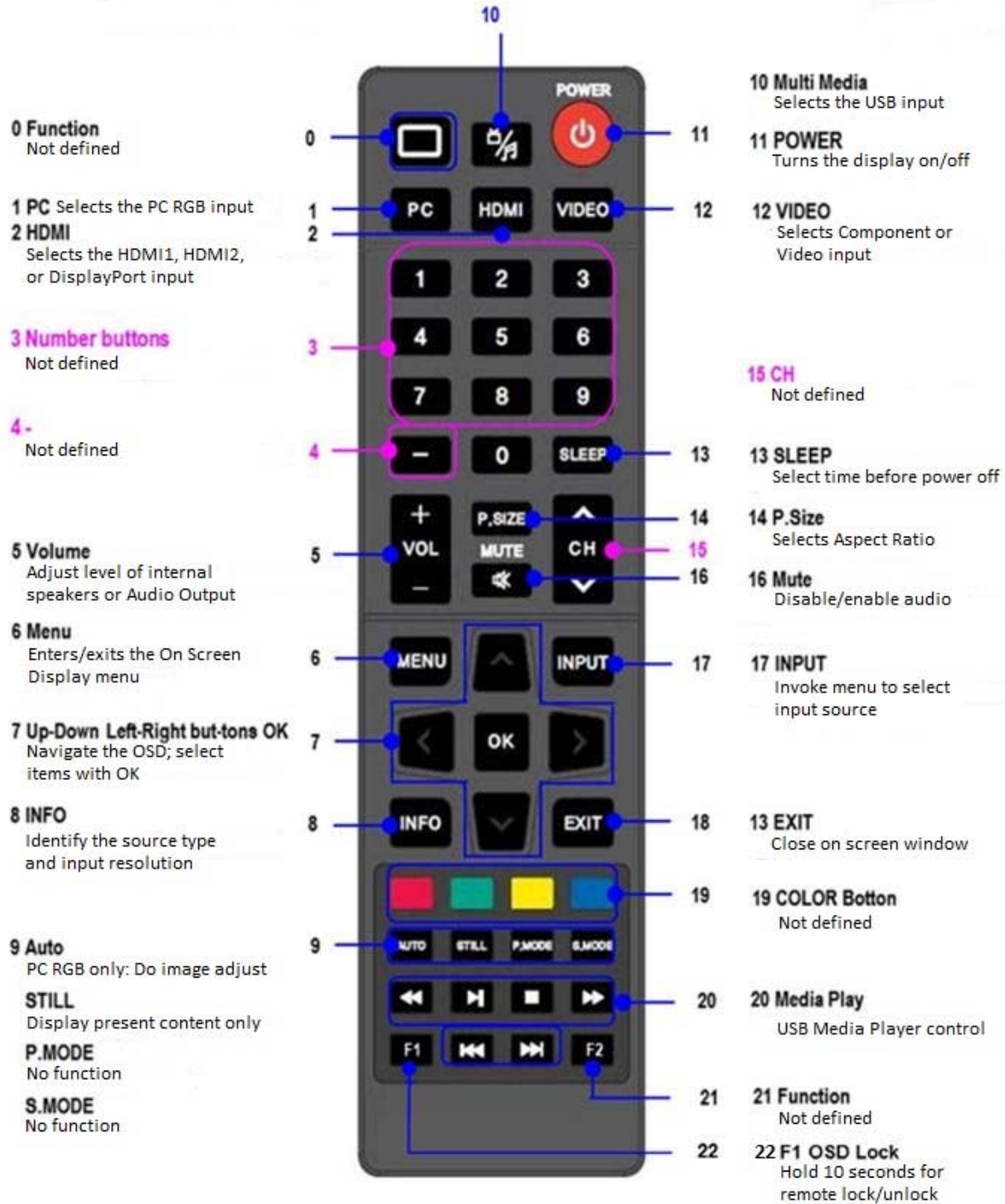

The Hex codes are shown below:

No.	Remote Key	Code [Hex]	No.	Remote Key	Code [Hex]
1	POWER	00 FF 8A 75	26	□	00 FF C7 38
2	PC	00 FF 8E 71	27	HDMI	00 FF 9E 61
3	VIDEO	00 FF 90 6F	28	1	00 FF 81 7E
4	MEDIA	00 FF 96 69	29	3	00 FF 83 7C
5	2	00 FF 82 7D	30	5	00 FF 85 7A
6	4	00 FF 84 7B	31	7	00 FF 87 78
7	6	00 FF 86 79	32	9	00 FF 89 76
8	8	00 FF 88 77	33	-	00 FF 98 67
9	0	00 FF 80 7F	34	VOL-	00 FF C0 3F
10	VOL +	00 FF 8B 74	35	P.SIZE	00 FF 8F 70
11	SLEEP	00 FF C2 3D	36	CH+	00 FF CC 33
12	MUTE	00 FF 97 68	37	MENU	00 FF 8C 73
13	CH-	00 FF DC 23	38	UP	00 FF 91 6E
14	INPUT	00 FF 9F 60	39	Right	00 FF 93 6C
15	Left	00 FF 92 6D	40	OK	00 FF 95 6A
16	Down	00 FF 94 6B	41	EXIT	00 FF 8D 72
17	INFO.	00 FF C1 3E	42	GREEN	00 FF 9A 65
18	RED	00 FF 99 66	43	BLUE	00 FF 9C 63
19	YELLOW	00 FF 9B 64	44	STILL	00 FF C5 3A
20	AUTO	00 FF C6 39	45	S.MODE	00 FF C3 3C
21	P.MODE	00 FF C4 3B	46	◀◀	00 FF CA 35
22	▶▶	00 FF D6 29	47	■	00 FF DE 21
23	▶	00 FF CE 31	48	◀◀	00 FF DD 22
24	▶▶	00 FF DF 20	49	F2	00 FF CF 30
25	F1	00 FF 9D 62			

Locking the Remote

To lock and unlock the remote control, hold the F1 button down for 10 seconds.

IR Sensor and LED Indicators

The IR sensor is located on the bottom right side of the front bezel. To operate the remote control, point the remote directly at the IR sensor. Make sure the batteries are installed in the remote before operation.

The LED indicator light is located in the IR sensor window. The following table explains the condition for each of the indicators.

LED Status	Condition
Green	Display turned on but no input detected
Red	Display turned off
Off	Display turned on and input detected

Using the Display in Portrait Mode

When looking at the rear of the display in landscape orientation, rotate the display counter-clockwise for portrait orientation. This will allow for proper ventilation. The directional indicator is located on the bottom of the product rating label for reference.

Caution: Improper ventilation may shorten the life of the display.

Using the Display in Flat or Tilted Orientation

The display is not recommended for use in flat orientation for tabletop, floor, or ceiling installations. LCD panels of this size are at risk of panel deflection, which can cause cosmetic sagging, brightness uniformity issues, a shortened life span, and malfunction of optional touch sensors. Installations where the display is tilted downward or upward at an angle may also be prone to these issues and are not recommended.

Turning the Display On

- 1 Insert the power cord into the display and the power outlet.
- 2 Press the power button on the remote or keypad.

Turning the Display Off

With the power on, press the power button on the remote or keypad to put the LCD panel in a standby mode. To turn off power completely, disconnect the AC power cord from the power outlet.

Note: If there is no signal for a 10 minutes on a HDMI, DisplayPort, or Component signal or 1 minute on a VGA signal and the Auto Sleep OSD setting is set to On, the LCD panel will automatically go into standby mode.

Selecting the Input Source

Input sources must be selected manually. Below are the ways you can select the input source:

- 1 Press the Input button on the remote control to activate the input onscreen menu. Use the arrow buttons to select the desired input source and press OK.



- 2 Using the remote control, select PC RGB, HDMI, or Video source to select your source. If desired source is not selected, press multiple times to toggle through the input options.

OSD Menu Functions

Press the MENU button on the remote or the keypad to activate the OSD.

Use the UP/DOWN/VOL+/VOL- buttons on the keypad or the UP/DOWN/LEFT/RIGHT buttons on the remote to navigate through the OSD submenus. The first menu to appear is the Picture Menu.

Picture Menu

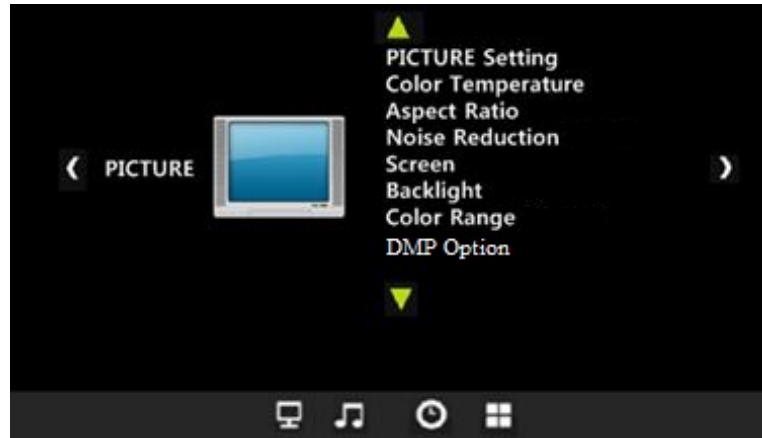

Item	Selection Options
Picture Settings	Brightness, contrast, tint, color, & sharpness: 0-100
Color Temperature	6500K/9300K/11000K/User
Aspect Ratio	4:3/16:9/Zoom 1/Zoom 2
Noise Reduction	Off/Low/Middle/High
Screen (PC RGB only)	Auto Adjust: When selected, the image will be auto adjusted Hor Pos, Vert Pos, Size, and Phase: 0-100
Backlight	0-100
Color Range	16-235, 0-255
DMP Option (USB only)	Auto play: On/off Show effect: Select from various slide show transition effects Slide time: 0-255 sec

Sound Menu

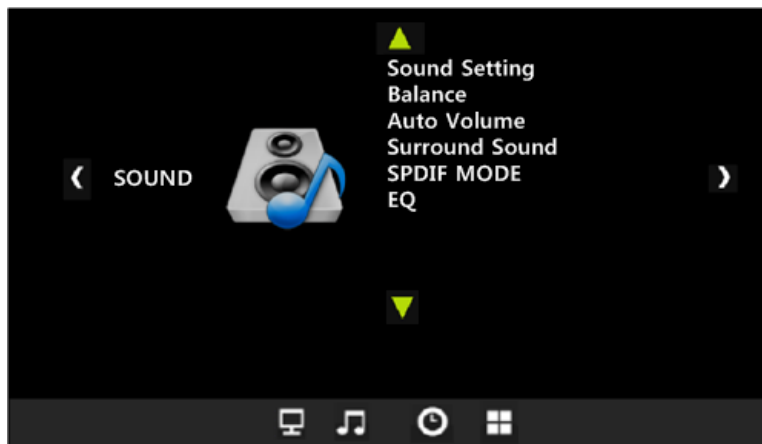

Item	Selection Options
Sound Setting	Treble and bass: 0-64
Balance	-50 to 50
Auto Volume	On/off
Surround Sound	Off/Surround/SRS
SPDIF Mode	Auto/PCM
EQ	120Hz, 500Hz, 1.5KHz, 10KHz: 0-64

Option Menu

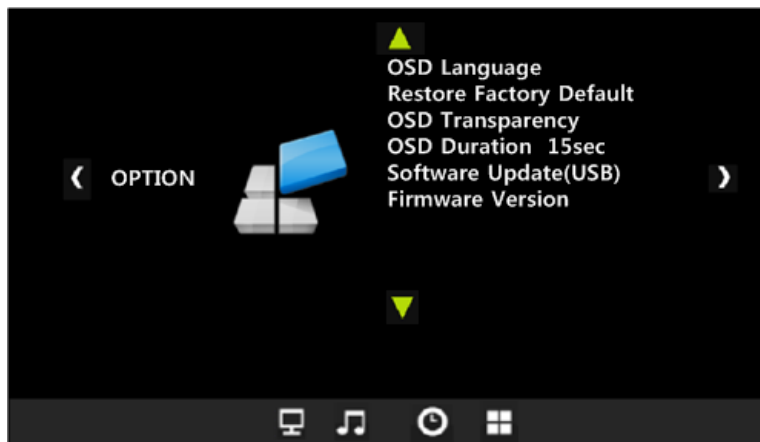

Item	Selection Options
OSD Language	English, French, German, Spanish, Chinese +18 other language options
Restore Factory Default	Yes/No
OSD Transparency	Off/Low/Middle/High
OSD Duration	5 sec/10 sec/15 sec/20 sec/off
Software Update	Yes/No
Firmware Version	Version will display if selected

Time Menu

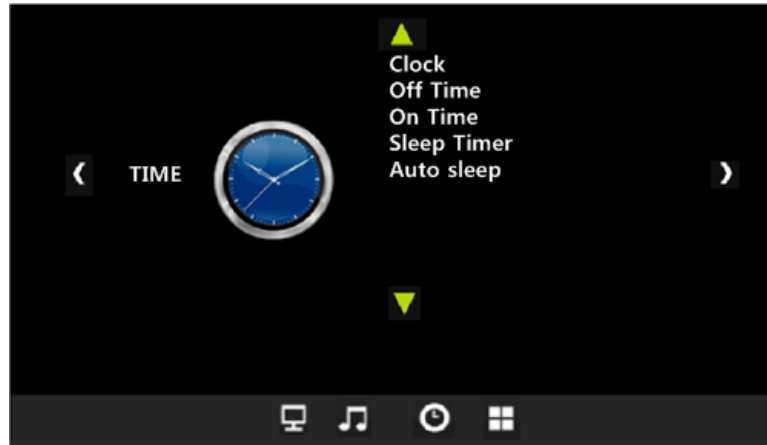

Item	Selection Options
Clock	Date/Month/Year/Hour/Minute
Off Time	Off/Once/Every Day/Mon-Fri/Mon-Sat/Sat-Sun/Sunday/ Hour/Minute
On Time	Off/Once/Every Day/Mon-Fri/Mon-Sat/Sat-Sun/Sunday/ Hour/Minute/Source/Volume
Sleep Timer	Off/10 min/20 min/30 min/ 60 min/ 90 min/ 120 min/ 180 min/ 240 min
Auto Sleep	On/Off

Playing Media Files

This display can play video, image, music, and text files from your USB device.

Connect your USB device to the USB port on the display. Select USB in the Input menu to activate the USB Media Menu.



Item	Selection Options
Photo	Select to play image files. Supported files: .jpeg, .bmp, .png
Music	Select to play audio files. Supported files: .aac, .mp3, .ogg, .pcm, .wav
Movie	Select to play video files. Supported files: .avi, .mkv, .mov, .mpg, .mp4 Video codecs supported (max resolution 1020x1080, 30 fps): MPEG1, MPEG2, MPEG4, H264, XVID
Text	Select to play text files. Supported files: .txt

- 1 This menu appears only if Auto Play is set to "off" in the Picture Menu under DMP option or if no media files are in the root folder.
- 2 The remote is required to operate the USB playback functionality unless Auto Play is set to "on".

Playing Videos

If you are in Auto Play mode (see page 20), the video will automatically play and the menu will not appear. To stop playback when Auto Play is set to “On”, press the Stop or Exit button on the remote. To change the Auto Play setting in the OSD, select any input other than USB.

To view video files, select “Movie”. Use the UP/DOWN/LEFT/RIGHT buttons on the remote to navigate through the thumbnail images of the video files on the USB. A preview of the video will show if a file is highlighted.

To play a video or set of videos, push the OK button on the remote to select the videos you wish to play. A red check mark will show once the file is selected. Once you have selected your playlist, press the ► button on the remote.

Caution: Pressing the red button on the remote when viewing thumbnail files will take you to a submenu that will delete files from the USB.

To stop the video, you can press the ■ button.

Pressing the “OK” or “INFO” buttons on the remote while a video is playing will activate the media menu bar at the bottom of the screen.

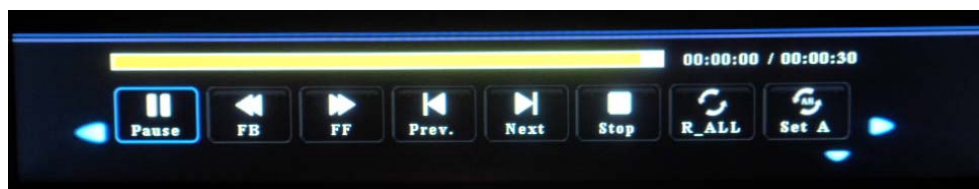

Scroll to highlight the desired selection and to view additional icons.

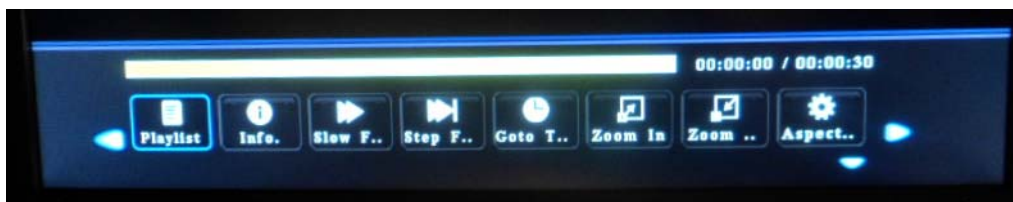

Media Menu Bar When Videos are Playing

Press the OK button on the remote to enable each function.

Item	Function
Play/Pause	Press OK when "Play" is showing to play the video. Press OK when "Pause" is showing to pause the video.
FB	Rewind the video. Each press of the OK button increases the speed.
FF	Fast forward the video. Each press of the OK button increases the speed.
Prev	Go to the previous video in the playlist.
Next	Go to the next video in the playlist.
Stop	Stop the video and go back to the playlist menu with the thumbnail images.
R_ALL/Random/ R_None/R_One	Press the OK button to rotate between 4 different looping options: <ul style="list-style-type: none"> • R_ALL: Loops videos in alphabetical order • Random: Loops videos in random order • R_None: Plays the current video once and then goes to then returns to the playlist menu with the thumbnail images • R_One: Loops the current video
Set A/Set B/None	Not functional
Playlist	List the files in the selected play loop
Info	List details on file playing, such as resolution, file size, and file date
Slow F	Enable slow motion. Each press of the OK button reduces the speed.
Step F	View one frame at a time.
Goto T	Activate an input search time box which enables you to select and go to a specific point on the video
Zoom In	Zooms in (Note: Not always supported)
Zoom Out	Zooms out (Note: Not always supported)
Aspect	Changes image shown from 16:9 to 4:3 (Note: Not always supported)

Press the down arrow button on the remote to exit the Media Menu Bar. If you press the Exit button on the remote, it will take you back to the playlist menu.

Playing Image Files

If you are in Auto Play mode (see page 20), the image will automatically display and the menu will not appear. To stop playback when Auto Play is set to "On", press the Stop or Exit button on the remote. To change the Auto Play setting in the OSD, select any input other than USB.

To view image files, select "Photo". Use the UP/DOWN/LEFT/RIGHT buttons on the remote to navigate through the thumbnail images of the image files on the USB.

To play a slideshow of images, push the OK button on the remote to select the images you wish to show. A red check mark will show once the file is selected. Once you have selected your playlist, press the ► button on the remote.

Caution: Pressing the red button on the remote when viewing thumbnail files will take you to a submenu that will delete files from the USB.

To stop the slideshow, you can press the ■ button.

Pressing the "OK" or "INFO" buttons on the remote while a slideshow is playing will activate the media menu bar at the bottom of the screen.

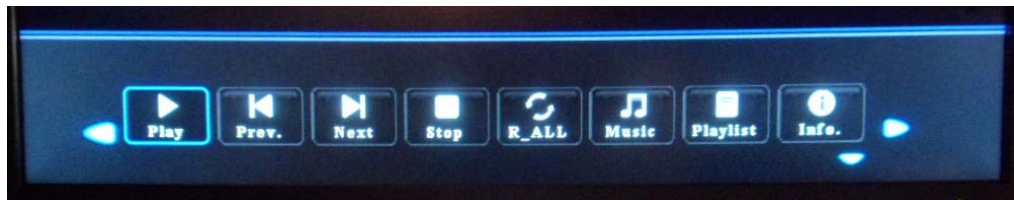

Scroll to highlight the desired selection and to view additional icons.



Media Menu Bar When Image Slideshows are Playing

Press the OK button on the remote to enable each function.

Item	Function
Play/Pause	Press OK when "Play" is showing to play the slideshow. Press OK when "Pause" is showing to pause the slideshow.
Prev	Go to the previous image in the playlist.
Next	Go to the next image in the playlist.
Stop	Stop the slideshow and go back to the playlist menu with the thumbnail images.
R_ALL/Random/ R_None/R_One	Press the OK button to rotate between 4 different looping options. <ul style="list-style-type: none"> • R_ALL: Loops images in alphabetical order • Random: Loops images in random order • R_None: Plays the current image once and then goes to then returns to the playlist menu with the thumbnail images • R_One: Loops the current image
Music	Not functional
Playlist	List the files in the selected play loop
Info	List details on file showing, such as resolution, file size, and file date
Rotate Clockwise	Rotates the image clockwise. Note: The image aspect ratio does not change. Portrait content will need to be rotated in the file itself.
Rotate Counter-clockwise	Rotates the image counter-clockwise. Note: The image aspect ratio does not change. Portrait content will need to be rotated in the file itself.
Zoom In	Zooms in (Note: Not always supported)
Zoom Out	Zooms out (Note: Not always supported)
Move	Moves the image around the screen if the image is zoomed in.

Press the down arrow button on the remote to exit the Media Menu Bar. If you press the Exit button on the remote, it will take you back to the playlist menu.

Slide show duration and transition is selected in the main menu. Click Menu on the remote to access. Go to DMP OPTION (see page 20).

RS232 Communication

RS232 control is not necessary for operation, but it is a convenient way to control displays from a computer at a distance. If your installation will not use RS232 control, you can skip this section. Most of the operations you can do with the remote, you can do with RS232 commands. Plus, you can send inquiries to the displays and find out the current settings and values. RS232 connections are made with standard straight through cables.

Connecting the RS232 Cable

The RS232 cable will connect to a PC or control system, depending on your setup.

RS232 Commands

The following table provides the RS232 commands that can be used.

The required serial port settings are:

Baud rate = 38400; Data bits = 8; Stop bits = 1; Parity = no

Item	Description	Code [HEX]
Power Off	Turn display power off	69 76 20
Power On	Turn display power on	69 A7 EF
HDMI1	Set the selected input to HDMI1	69 A1 F5
HDMI2	Set the selected input to HDMI2	69 A2 F4
DP	Set the selected input to DisplayPort	69 A3 F3
USB	Set the selected input to USB	69 A6 F0
PC	Set the selected input to PC RGB	69 A0 F6
Component	Set the selected input to Component	69 A5 F1
AV	Set the selected input to Composite	69 A4 F2
VOL UP	Increment the speaker volume	69 C2 D4
VOL DOWN	Decrement the speaker volume	69 C3 D3
Get Power Status	Returns in ASCII either "Power on" or "Power off"	FF 04 01 00
Get Input Selected	Returns "HDMI1", "HDMI2", "DP", "PC-RGB", "Media mode", "Component", "AV", or nothing if off	FF 04 02 00
Get Input Status	Returns "Support" if source is detected; "No signal" if no source detected; nothing if off	FF 04 03 00
Set Volume to "X"	For example, xx = 32 to set Volume to 50	FF 04 04 xx
Get Volume	Returns "Volume = xx" where xx is 0 to 100	FF 04 05 00
Set Mute to "X"	01 = Mute; 02 is Unmute	FF 04 06 01/02
Get Mute	Returns "Unmute" or "Mute"	FF 04 07 00

Item	Description	Code [HEX]
Set Contrast to "X"	For example, xx = 30 to set Contrast to 48	FF 04 08 32
Get Contrast	Returns "Contrast = xx" where xx is 0 to 100	FF 04 09 00
Set Brightness to "X"	For example, xx = 34 to set Brightness to 52	FF 04 0A 32
Get Brightness	Returns "Brightness = xx" where xx is 0 to 100	FF 04 0B 00
Set Color to "X"	For example, xx = 32 to set Color to 50	FF 04 0C 32
Get Color	Returns "Color = xx" where xx is 0 to 100	FF 04 0D 00
Set Color Temp to "X"	00 is 11000; 01 is 9300; 02 is 6500; 03 is User	FF 04 0E 00/01/02
Get Color Temp	Returns "Color temp is" and then "11000k", "9300k", "6500k", or "User setting"	FF 04 0F 00
Set Sharpness to "X"	For example, xx = 32 to set Sharpness to 50	FF 04 10 32
Get Sharpness	Returns "Sharpness = xx" where xx is 0 to 100	FF 04 11 00
Get Aspect Ratio	Returns "16x9", "4x3", "Zoom1", or "Zoom2"	FF 04 13 00
Set Backlight to "X"	For example, xx = 32 to set Brightness to 50	FF 04 14 32
Get Backlight	Returns "Brightness = xx" where xx is 0 to 100	FF 04 15 00
Set Color Range to "X"	"01" is limited range input (16-235), "02" is full range input (0-255)	FF 04 16 01/02
Get Color Range	Returns "Color range is" and then "0-255" or "16-255" (Note: The 16-255 response contains a typo; this should be 16-235.)	FF 04 17 00
Set USB Slide Time to "X"	For slide show, sets the duration for each image: 01 is 1 sec; 02 is 2 sec; 03 is 3 sec; and so on. 0A = 10 sec, FF = 255 sec	FF 04 18 XX
Get USB Slide Time	Returns "slide time = x" where x is in seconds	FF 04 19 00
Get Firmware Version	Returns "Firmware Version is x.x"	FF 04 1A 00
Restore Factory Default	Restores all settings to factory defaults	FF 04 1B 00
Get Clock	Returns the present time and date: "1 - 1 - 2014 00:03"	FF 04 1D 00
Get Off Time	Returns the time at which the display is scheduled to turn off. For example, "04:03" (hour and minute)	FF 04 1F 00
Get Off Time Settings	Returns the frequency of the off scheduling. For example, "Once", "Every day", and so on	FF 04 21 00
Get On Time	Returns the time at which the display is scheduled to turn on. For example, "04:03" (hour and minute)	FF 04 23 00
Get On Time Settings	Returns the frequency of the on scheduling. For example, "Once", "Every day", and so on	FF 04 25 00
Set Sleep Timer to "X"	Set the duration until the display automatically turns off: 0 = never, 1 = 10 min, 2 = 20 min, 3=30, 4=60, 5=90, 6=120, 7=180, 8=240 min	FF 04 26 0X
Get Sleep Timer	Returns the sleep timer settings. For example, "240 Min"	FF 04 27 00

Item	Description	Code [HEX]
Set Lock to "X"	"01" is lock out both the keypad and the IR remote; "02" is unlock	FF 04 2A 01/02
Get Lock Status	Returns "lock" or "unlock"	FF 04 2B 00
INPUT	Open the source selection OSD / move down in source selection menu	69 90 06
MENU	Open or close the main OSD or move back one submenu level	69 73 23
LEFT	Navigate left in OSD or decrease selected value	69 72 24
RIGHT	Navigate right in OSD or increase selected value	69 74 22
DOWN	Open Picture Settings OSD or navigate down in OSD	69 83 13
UP	Navigate up in OSD	69 63 33
OK	Select the highlighted item	69 96 00
EXIT	Exit the menu	69 84 12

Note: If RS232 commands do not function properly, contact Planar Technical Support to receive instructions for updating firmware.

Touch Screen Operation

To use the integrated touch capabilities of the PS7050T and PS8250T, follow these simple instructions.

- 1 Connect the USB Type B side of the USB cable included in the accessory kit to the connector on the display I/O panel.
- 2 Connect the USB Type A side of the cable to the PC.
- 3 For Windows and Linux operating systems, a driver is not required to enable touch on the display. For MacOSX, a driver is required and can be found on www.planar.com/support.

The PS7050T and PS8250T are calibrated before shipment, so there should be no need to calibrate out of the box. If calibration is desired and the operating system is Windows 7 or 8, go to: CONTROL PANEL > TABLET PC SETTINGS, then clicking on "Calibrate" as shown below.

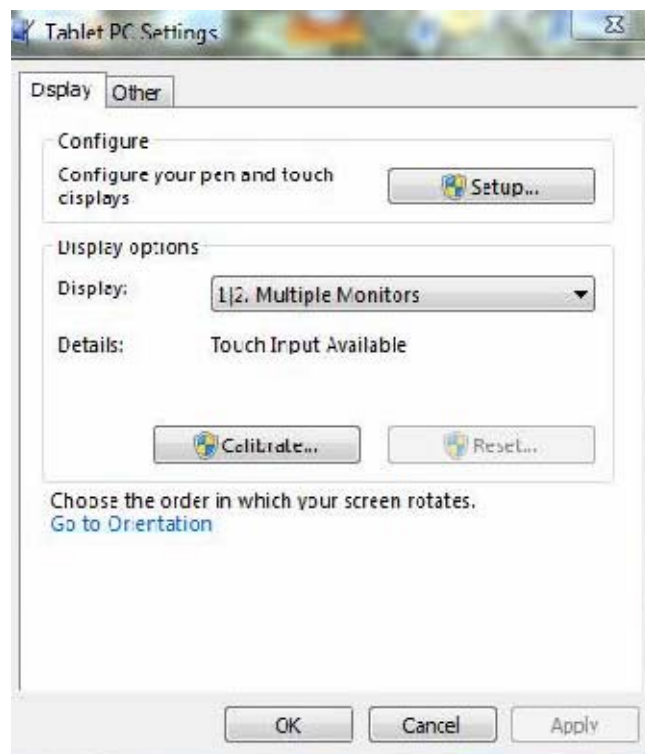

When you click on Calibrate, a grid pattern shows on the screen with touch points identified. Touch all of the identified points, then hit "yes" at the end to store the calibration.

Signal Compatibility

Signal Type	Resolution	Frame Rate (Hz)	HDMI	DisplayPort	PC RGB	Component	Composite (CVBS video)
PC	640x480	60	Y	Y	Y		
PC	640x480	67	Y	Y	Y		
PC	640x480	72	Y	Y	Y		
PC	640x480	75	Y	Y	Y		
PC	720x400	70	Y	Y	Y		
PC	800x600	56	Y	Y	Y		
PC	800x600	60	Y	Y	Y		
PC	800x600	72	Y	Y	Y		
PC	800x600	75	Y	Y	Y		
PC	1024x768	60	Y	Y	Y		
PC	1024x768	70	Y	Y	Y		
PC	1024x768	75	Y	Y	Y		
PC	1152x864	60			Y		
PC	1152x870	75	Y	Y	Y		
PC	1280x720	60	Y				
PC	1280x800	60			Y		
PC	1280x960	60			Y		
PC	1280x1024	60	Y	Y	Y		
PC	1360x768	60		Y			
PC	1366x768	60	Y				
PC	1400x1050	60		Y	Y		
PC	1600x1200	60			Y		
PC	1680x1050	60	Y	Y			
PC	1920x1080	60	Y	Y	Y		
NTSC	720x480	60					Y
PAL	720x576	50					Y
SDTV	480i	60				Y	
SDTV	576i	50				Y	
EDTV	480p	60	Y	Y		Y	
EDTV	576p	50	Y	Y		Y	

Signal Type	Resolution	Frame Rate (Hz)	HDMI	DisplayPort	PC RGB	Component	Composite (CVBS video)
HDTV	1080i	50	Y			Y	
HDTV	1080i	60	Y			Y	
HDTV	720p	24	Y	Y			
HDTV	720p	50	Y	Y		Y	
HDTV	720p	60	Y	Y		Y	
HDTV	1080p	24	Y	Y		Y	
HDTV	1080p	25				Y	
HDTV	1080p	30	Y	Y		Y	
HDTV	1080p	50	Y	Y		Y	
HDTV	1080p	60	Y	Y		Y	

Specifications

Model	PS7050	PS7050T	PS8250	PS8250T
Viewable Size	70" Diagonal		82" Diagonal	
Brightness (typ)	400 cd/m ²		450 cd/m ²	
Contrast Ratio (typ)	4000:1		5000:1	
Display Resolution	FHD 1080p (1920 x 1080)			
Response Time (typ)	8 ms			
Refresh Rate	60 Hz			
Pixel Pitch	0.807mm x 0.807mm		0.9405mm x 0.9405mm	
Color Gamut	70% NTSC			
Viewing Angle (typ)	178° H and V			
External Connections	HDMI x 2, DisplayPort, VGA, Component, Composite, PC Audio In, Line Out, SPDIF out, USB			
Display Control	RS232 in, IR (lockable), Keypad (lockable)			
Power Requirements	100-240V; 50/60Hz			
Power Consumption (max)	280W		400W	
Fanless	Yes			
VESA mount pattern	800x400		600x600	
Bezel width	1.7" (42mm)	1.6" (40mm)	Top: 1.6" (40mm) Bottom: 1.8" (45mm) Sides: 1.6" (41mm)	Top/bottom: 1.5" (39mm) Sides: 1.6" (40mm)
Cabinet Dimensions (W x H x D)	64.3" x 37.6" x 2.7" (1634.3mm x 956.0mm x 68.0mm)	64.3" x 37.6" x 3.3" (1634.3mm x 956.0mm x 83.6mm)	74.5" x 43.5" x 2.8" (1891.3mm x 1103.9mm x 70.3mm)	74.5" x 43.2" x 3.4" (1891.3mm x 1097.7mm x 87.0mm)
Display Weight	128 lbs (58 kg)	185 lbs (84 kg)	183 lbs (83kg)	238 lbs (108kg)
Shipping Weight	154 lbs (70 kg)	211 lbs (96 kg)	209 lbs (95kg)	265 lbs (120kg)
Orientation	Landscape/Portrait		Landscape	
Speakers	10W x 2 built-in			
Touch Technology	N/A	IR 10 point touch	N/A	IR 10 point touch
OS Compatibility	N/A	Windows 8, 7, Vista, XP, Mac OSX, and Linux	N/A	Windows 8, 7, Vista, XP, Mac OSX, and Linux
Protective Glass	N/A	Anti-glare tempered	N/A	Anti-glare tempered

Dimensions

PS7050 - Front and Side

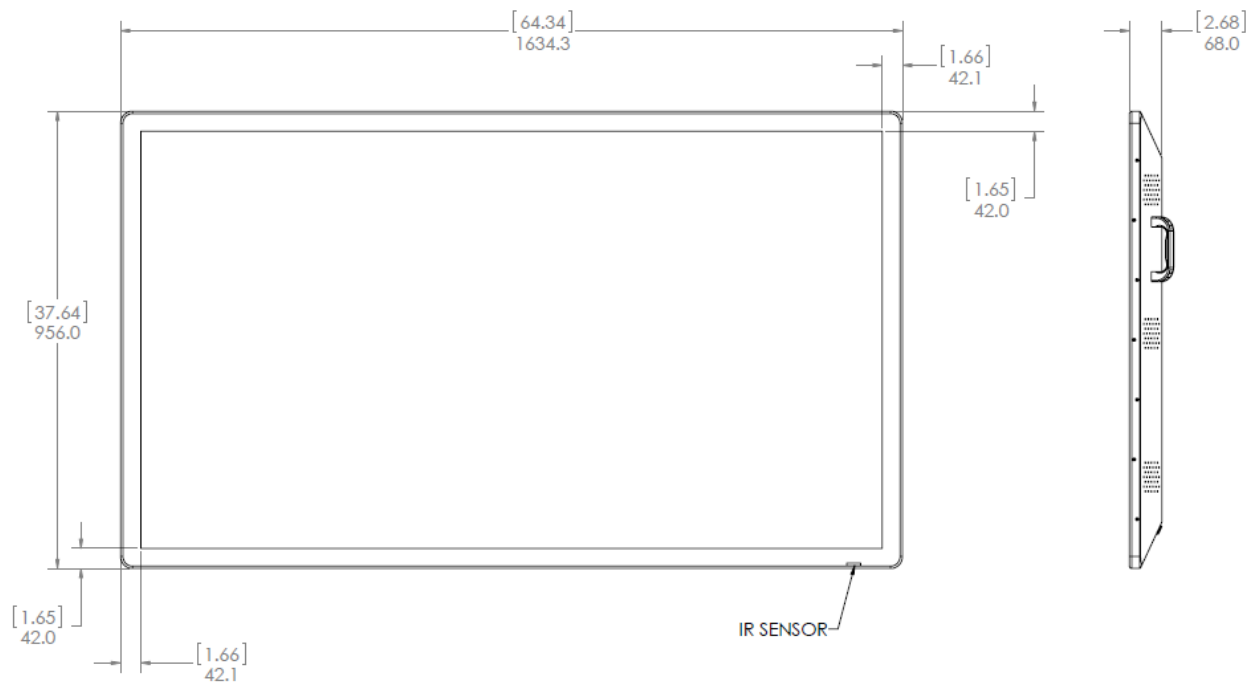

PS7050 - Rear

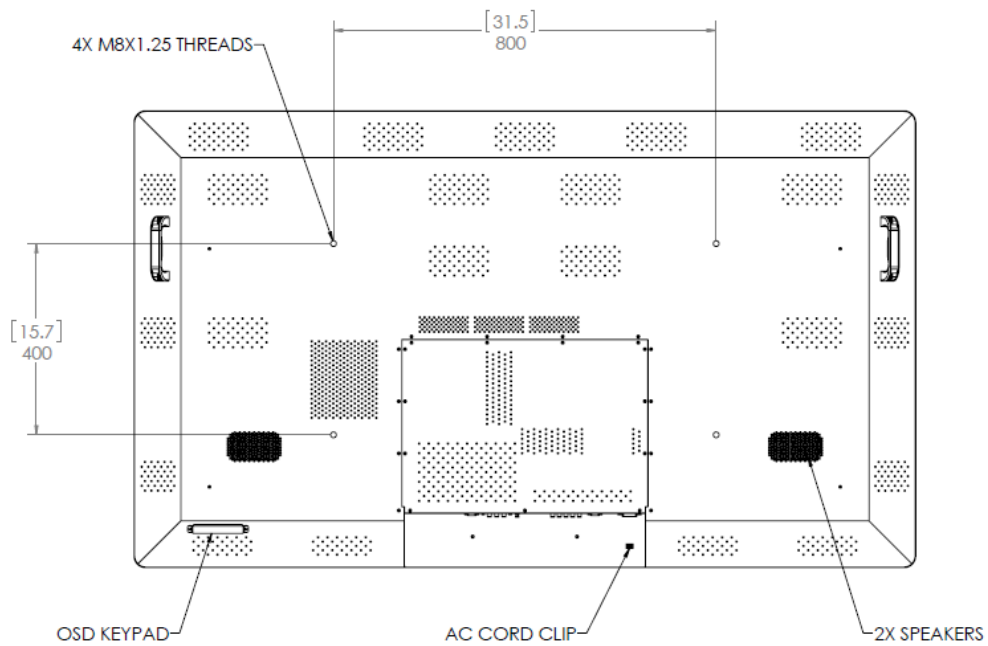

PS7050T - Front and Side

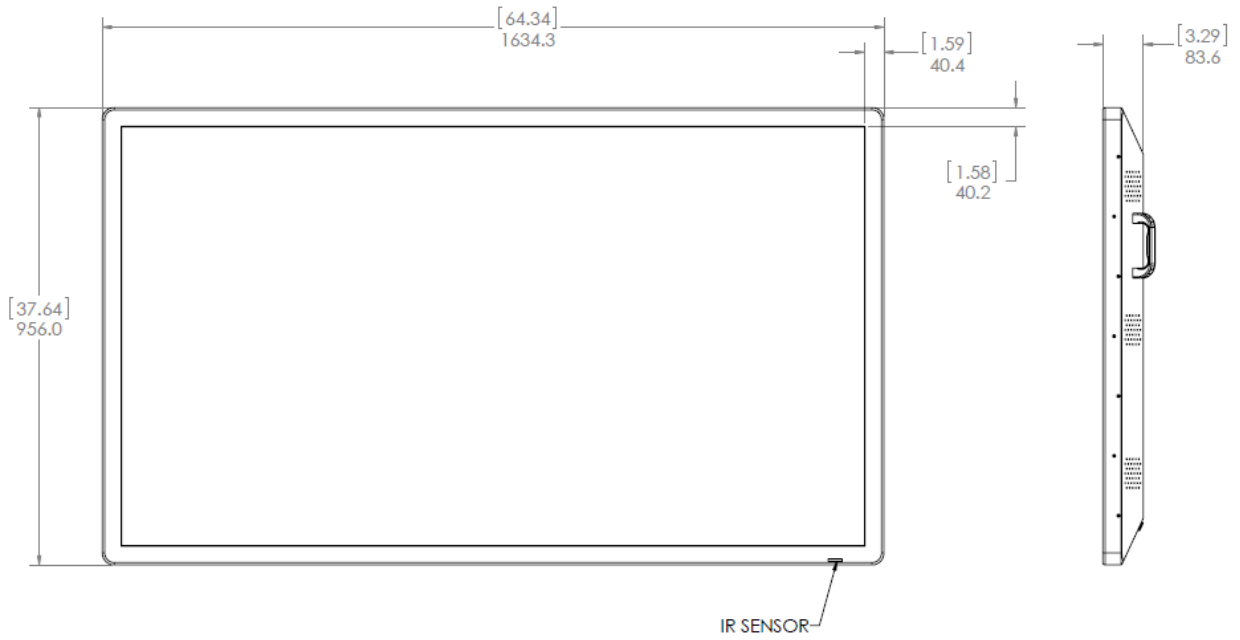

PS7050T - Rear

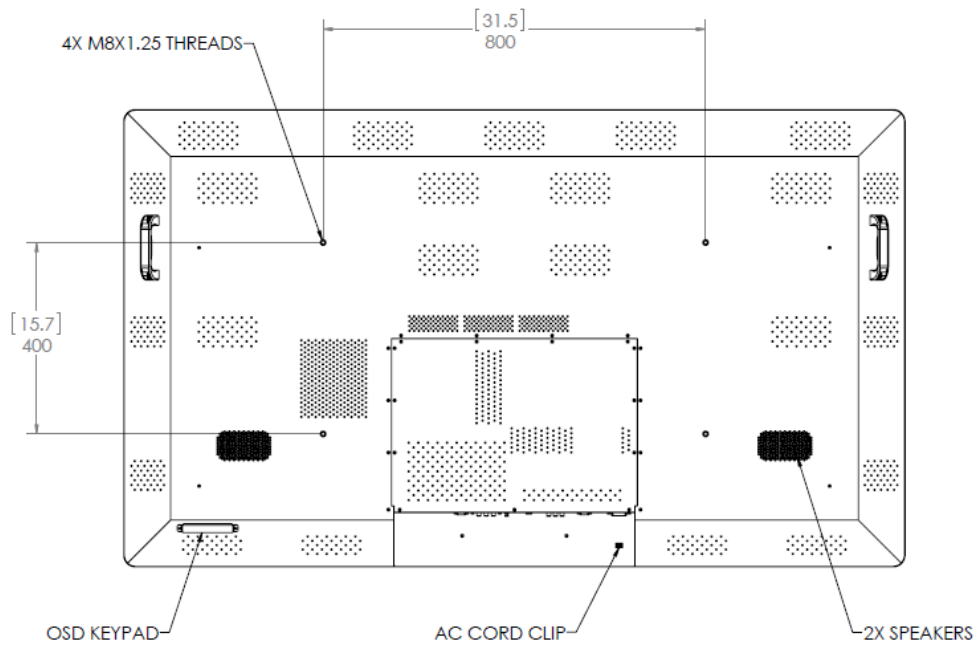

PS8250 - Front and Side

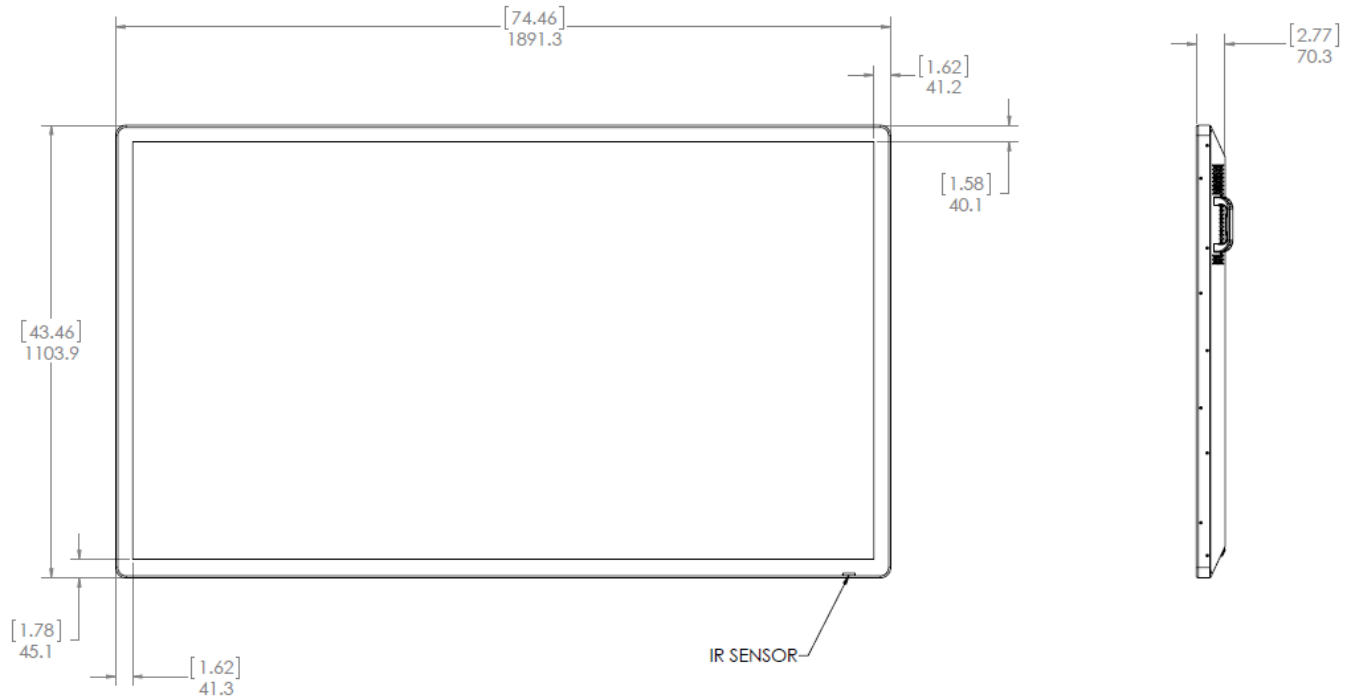

PS8250 - Rear

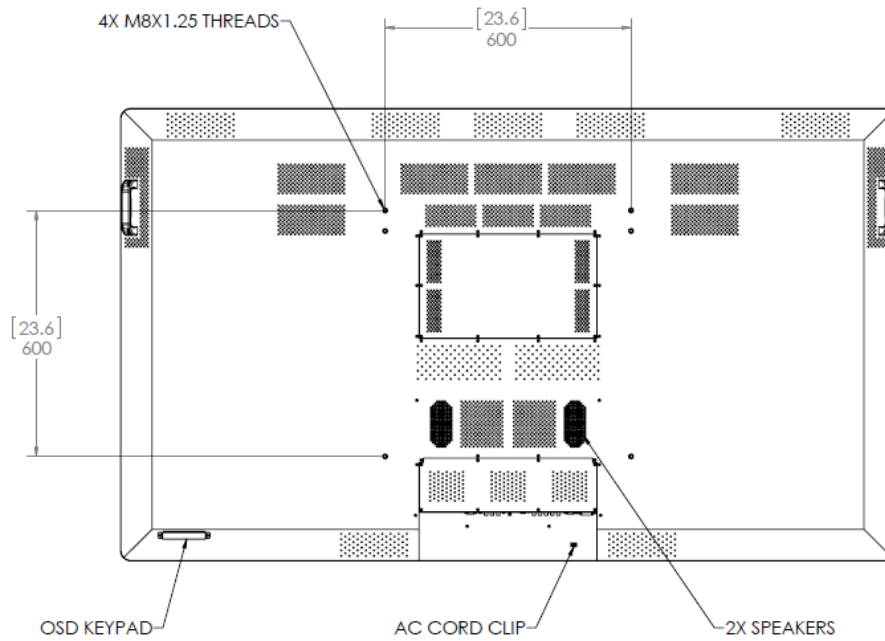

PS8250T - Front and Side

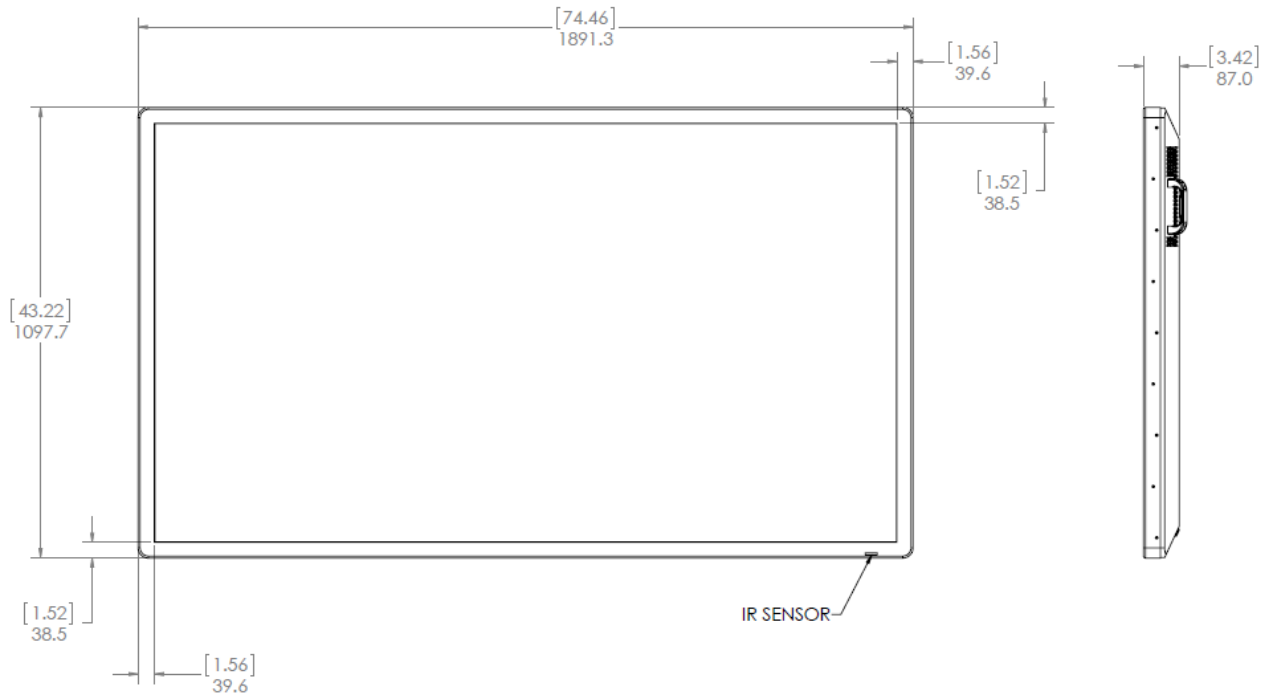

PS8250T - Rear

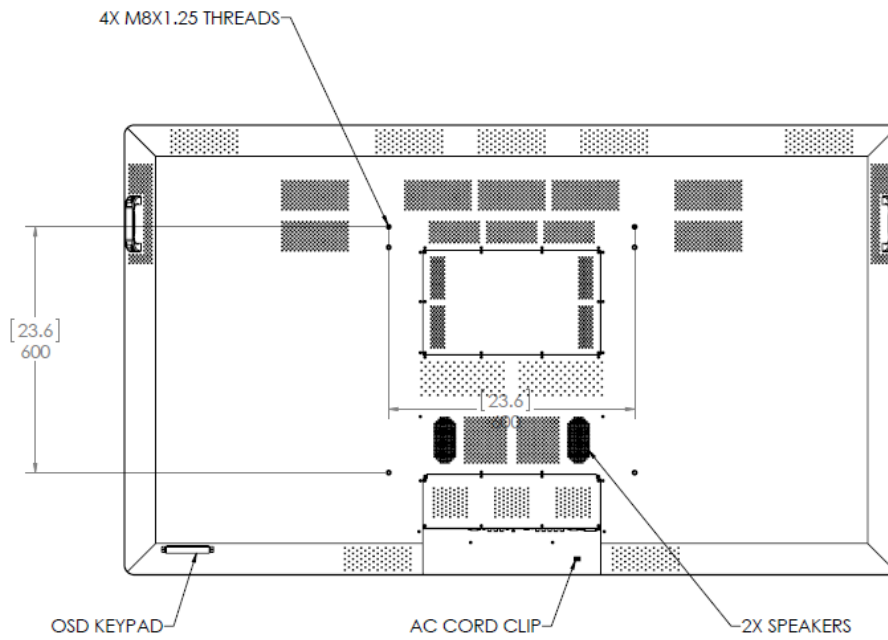

Troubleshooting

Before calling service personnel, please check the following table for a possible cause of the problem you are experiencing. Please note the following:

- Perform the adjustments according to "Operating the Display" on page 15.
- If the problem you have experienced isn't described below or you can't correct the problem, stop using the display and contact Planar's Technical Support Department. (See "Accessing Planar Technical Support" on page 41)

Issue	Check for the following
No image is displayed	Make sure the correct source is selected.
	Check that the source equipment is operating correctly.
	Make sure the input signal is compatible with this display.
The image is not centered	Make sure the input signal is compatible with this display.
The remote control doesn't work	Make sure the batteries are new and are installed correctly.
	Ensure the remote is aimed at the IR sensor.
	Make sure the remote is unlocked
The picture color looks poor	Check the picture settings. Reset the display.
Touch is not working	Ensure the USB cable is installed correctly on both ends. Also make sure that you are using one of the supported operating systems. Install touch driver found on http://www.planar.com/support .

Accessing Planar Technical Support

Go to <http://www.planar.com/support> to locate the following support documents and resources:

- User Guide
- Touchscreen Drivers
- Standard warranties
- Planar support hotline number and email

EMC (Electro Magnetic Compatibility) Certification

This device complies with Part 15 of the FCC Rules. Operation is subject to the following two conditions: (1) this device may not cause harmful interference, and (2) this device must accept any interference received, including interference that may cause undesired operation.

Caution: Changes or modifications not expressly approved by the party responsible for compliance could void the user's authority to operate the equipment.