



PX171M
LCD Monitor

USER'S GUIDE

www.planar.com

Table of Contents

Usage Notice

<i>Precautions</i>	2
--------------------------	---

Introduction

<i>About the Product</i>	3
<i>Package Overview</i>	4

Installation

<i>Product Overview</i>	5
<i>Connecting the Display</i>	7

User Controls

<i>Front Panel Controls</i>	10
<i>How to Use the OSD Menus</i>	11
<i>On-Screen Display Menus</i>	12

Appendices

<i>Troubleshooting</i>	16
<i>Warning Signal</i>	17
<i>Product Dimensions</i>	18
<i>Compatibility Modes</i>	19
<i>Pivot Software Installation</i>	20

Usage Notice



Warning- To prevent the risk of fire or shock hazards, do not expose this product to rain or moisture.



Warning- Please do not open or disassemble the product as this may cause electric shock.

Precautions

Follow all warnings, precautions and maintenance as recommended in this user's manual to maximize the life of your unit.

Do:

- Turn off the product before cleaning.
- Use only a dry soft cloth or clean room wiper when cleaning the LCD panel surface.
- Use a soft cloth moistened with mild detergent to clean the display housing.
- Use only high quality and safety approved AC/DC power adapter.
- Disconnect the power plug from AC outlet if the product is not used for a long period of time.

Don't:

- Do not touch the LCD panel surface with sharp or hard objects.
- Do not use abrasive cleaners, waxes or solvents for your cleaning.
- Do not operate the product under the following conditions:
 - Extremely hot, cold or humid environment.
 - Areas susceptible to excessive dust and dirt.
 - Near any appliance generating a strong magnetic field.
 - Place in direct sunlight.

Introduction

About the Product

Having a 17" flat panel screen with an active matrix, thin-film transistor (TFT) liquid crystal display (LCD) , this product also demonstrates following outstanding features:

- ❑ Analog and Digital signal input
- ❑ Active matrix TFT LCD technology
- ❑ 1280 x 1024 addressable pixels
- ❑ 17" diagonal screen size
- ❑ 31.5 ~ 80 kHz horizontal scan
- ❑ 56 ~ 75 Hz refresh rate
- ❑ VESA wall mountable
- ❑ Auto-adjustment
- ❑ Multilingual OSD user controls
- ❑ Adjustment stand design brings users the conveniences for easy storage and VESA Mounting applications
- ❑ VESA DPMS power saving
- ❑ Built-in speakers for multimedia application
- ❑ Kensington lock capability

Package Overview

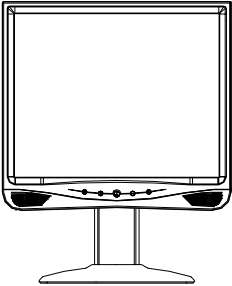

LCD Display

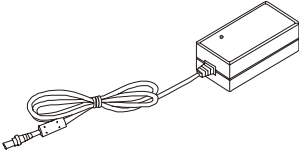

Power Adapter

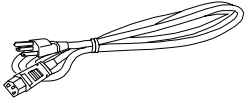

Power Cord

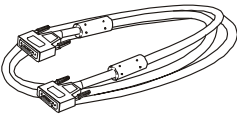

VGA Signal Cable

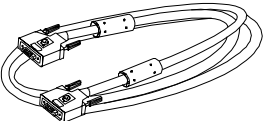

DVI-D Cable



Audio-In Cable

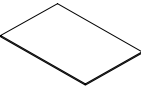

User's Manual



Quick Start Guide



Planar Product Family CD



CD-ROM for
Pivot software

Installation

Product Overview

◆ Front View

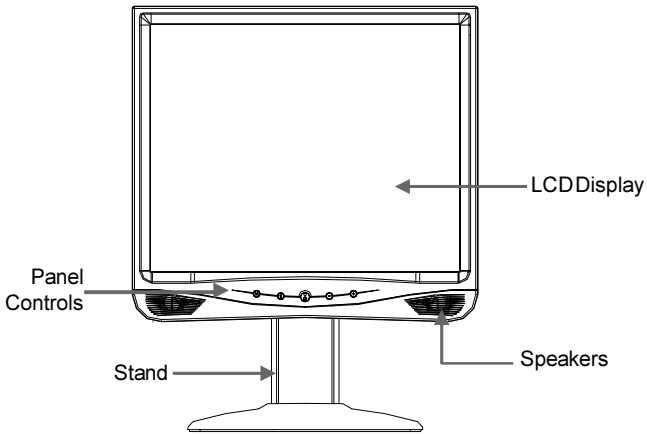

◆ Rear View

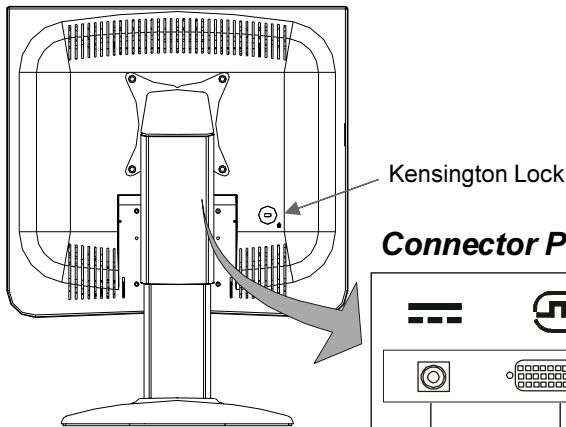

Connector Ports

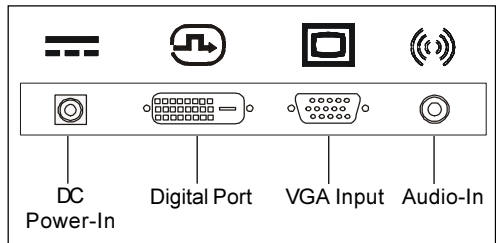

VESA Mount on your monitor

This monitor conforms to the VESA Flat Panel Mounting Physical Mounting Interface Standard which defines a physical mounting interface for flat panel monitors, and corresponding standards for flat panel monitor mounting devices, such as wall and table arms. The VESA mounting interface is located on the back of your monitor.

To mount the monitor on a swing arm or other mounting fixture, follow the instruction included with the mounting fixture to be used.

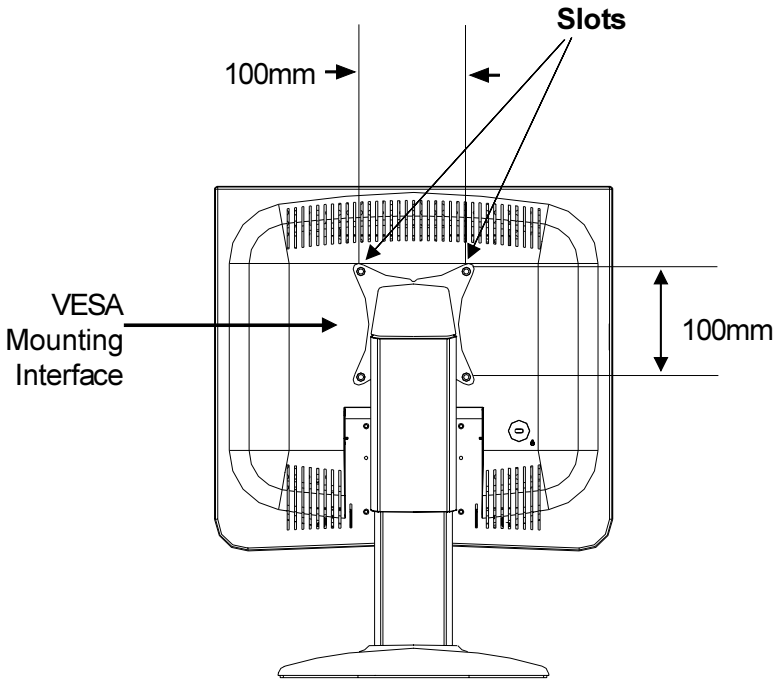

Warning!

Please must select the proper screws!

The depth from plastic back cover to the bottom of the screw hole is 8mm.

The spec is M4 screw.

Connecting the Display (Figure 8.1)

To setup this display, please refer to the following figure and procedures.

1. Be sure all equipments are off.
2. Connect the DC power cord to the power connector; plug one end of the AC power cord into the power adapter, and then the other end into an electrical outlet(❶).
3. Connect the VGA signal cable from display VGA input connector to the 15-pin connector of your host computer and tighten the screws(❷).
4. For the PC with DVI digital output: Connect the DVI signal cable to the connector of the display card in your computer; connect the other side to the DVI-D input port of your display. Tighten the screws(❸).
5. Connect the Audio-In cable from audio input port of your display to the Audio-out port of your computer(❹).
6. Turn on your computer and display.

Note: *To ensure the LCD display can work well with your computer, please configure the display mode of your graphic card to make it less than or equal to 1280 x 1024 resolution and make sure timing of the display mode is compatible with the LCD display. We have listed the “Compatibility Modes” of this LCD display in appendices for your reference.*

Figure 8.1

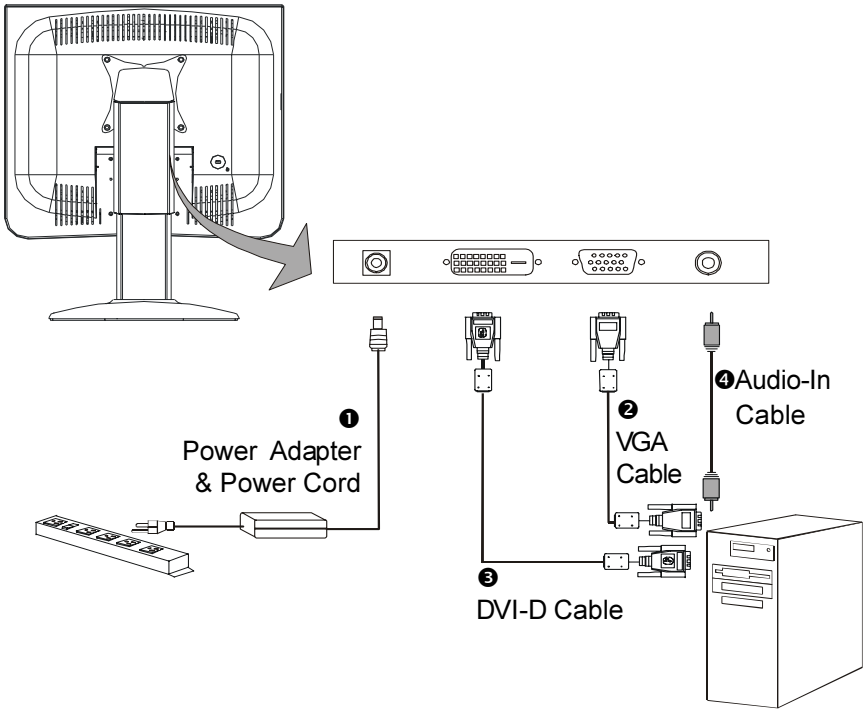

Vertical Height

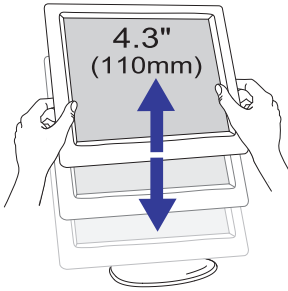

Portrait/Landscape

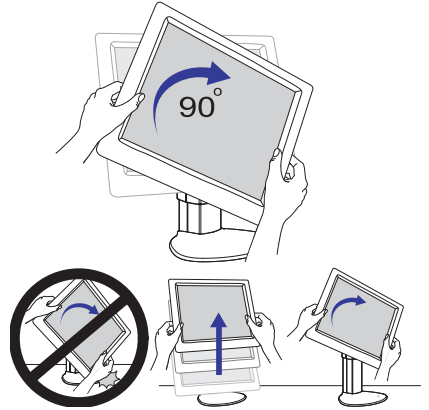

Left to Right Pan

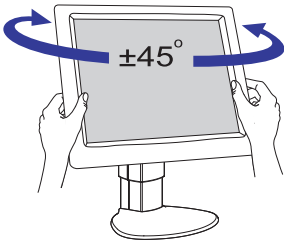

Front to Back Tilt

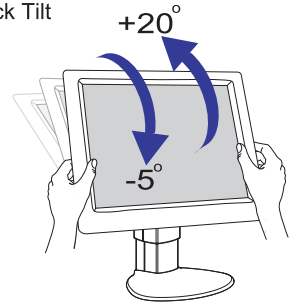

Remove Monitor

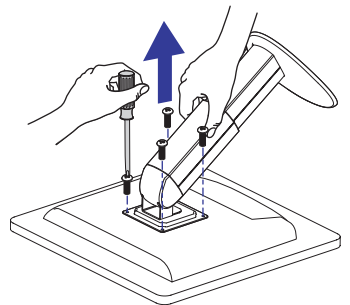
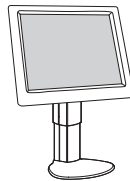
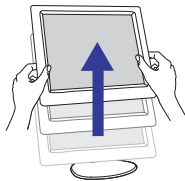
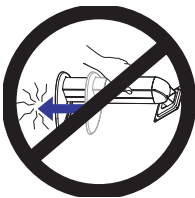



Base may forcefully extend and cause injury
Lift Monitor to "Full Up" position before
picking up the Base or removing the monitor

User Controls

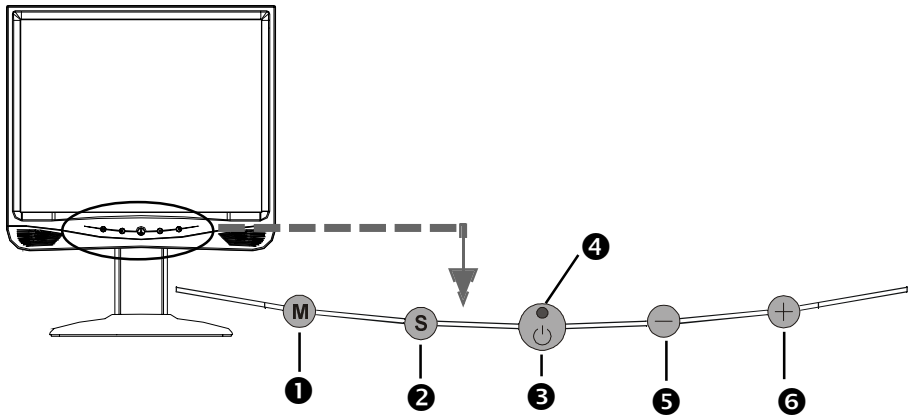
Front Panel Controls



No. / Icon	Control	Function
① M	Menu Button	Display the OSD menus.
② S	Select /Auto	<ol style="list-style-type: none"> To select the adjustment items from OSD menus. To activate the “Auto Adjustment” function to obtain an optimum image.
③ 	Power	Switch on/off the power of the LCD display.
④ 	Power LED	<ol style="list-style-type: none"> Green indicates the display is turned on. Amber indicates the display is in power-saving mode.
⑤ -	1. Minus / 2. Brightness	<ol style="list-style-type: none"> Decrease value of the adjustments items. Adjust the brightness of image.
⑥ +	1. Plus / 2. Mute On/Off	<ol style="list-style-type: none"> Increase value of the adjustment items. Make the volume function Ineffective/effective.

How to Use the OSD Menus

1. Press the “M” button to pop up the on-screen menu and to select between the four Main Menus.
2. Choose the adjustment items by pressing the “S” button.
3. Adjust the value of the adjustment items by pressing the “_” or “+” button.
4. Once you don’t operate the OSD menus after a pre-set time, the OSD menu will automatically disappear.

On-Screen Display Menus

First OSD Menu:

▶ **Auto-Adjustment**

Chooses this function to obtain an optimum image.

▶ **Contrast**

Adjusts the contrast of the display image.

▶ **Brightness**

Adjusts the brightness of the display image.

▶ **Horizontal Position**

Changes the horizontal position of the image.

▶ **Vertical Position**

Changes the vertical position of the image.

▶ **Clock**

Changes the display data frequency to match the frequency of your graphic card. When you are experiencing vertical flickering bar, use this function to make an adjustment.

▶ **Phase**

Synchronizes the signal timing of the display to that of the graphic card.

When you are experiencing unstable to flickering image, use this function to make an adjustment.

Second OSD Menu:

▶ **Display Mode**

Selects this function to demonstrate the display resolution, vertical refresh, and horizontal scan of the current mode.

▶ **OSD Off-Time**

Adjusts the time period for OSD menu disappear.

▶ **Language**

Chooses the language you need.

▶ **Sharpness**

Adjust the sharpness of the image.

▶ **Reset**

Returns the display parameters of the current mode to its factory default settings.

Third OSD Menu:

▶ **Volume**

It allows you to control the volume sound.

▶ **Mute**

It allows you to disable the sound immediately.

▶ **Input Select**

It allows you to select the type of signal.

Fourth OSD Menu:

▶ **Color Setting**

Adjusts the color temperature.

▶ **Color Adjustment-Red**

It allows you to adjust the red color of the display.

▶ **Color Adjustment-Green**

It allows you to adjust the green color of the display.

▶ **Color Adjustment-Blue**

It allows you to adjust the blue color of the display.

Appendices

Troubleshooting

If you are experiencing trouble with the LCD display, refer to the follows. If the problem persists, please contact your local dealer or our service center.

Problem: No image appears on screen.

- ▶ Check that all the I/O and power connectors are correctly and well connected as described in the “ Installation ” section.
- ▶ Make sure the pins of the connectors are not crooked or broken.

Problem: Partial image or incorrectly displayed the image.

- ▶ Check to see if the resolution of your computer is higher than that of the LCD display.
- ▶ Reconfigure the resolution of your computer to make it less than or equal to 1280 x 1024.

Problem: Image has vertical flickering line bars.

- ▶ Use “ Frequency ” to make an adjustment.
- ▶ Check and reconfigure the display mode of the vertical refresh rate of your graphic card to make it compatible with the LCD display.

Problem: Image is unstable and flickering

- ▶ Use “ Tracking ” to make an adjustment.

Problem: Image is scrolling

- ▶ Check and make sure the VGA signal cable (or adapter) is well connected.
- ▶ Check and reconfigure the display mode of the vertical refresh rate of your graphic card to make it compatible with the LCD display.

Problem: Vague image (characters and graphics)

- ▶ Use “ Frequency ” to make an adjustment. If this problem still exists, use “Tracking” to make an adjustment.

Warning Signal

Sometimes you probably will see the warning messages from this LCD screen. This means that the LCD display cannot exactly receive the signal from the computer graphic card.

There are three kind of situations may happen. Please check with the connected cables or contact your local dealer for more information.

▶ **No Signal**

This message means that the LCD display has been powered on but it cannot receive any signal from the computer graphic card. Check all the power switches, power cables, and VGA signal cable.

▶ **Going to Sleep**

This message means that the LCD display is under the power saving mode. In addition, the LCD display will go to this sleeping mode when experiencing a sudden signal disconnecting problem.

▶ **Unsupport Mode**

This message means that the signal of the computer graphic card is not compatible with the LCD display. When the signal is not included in the compatibility mode we have listed in the Appendices of this manual, the LCD display will appear this message.

Product Dimensions

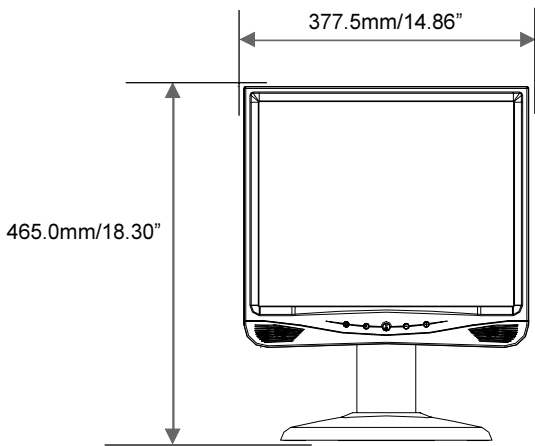

Front View

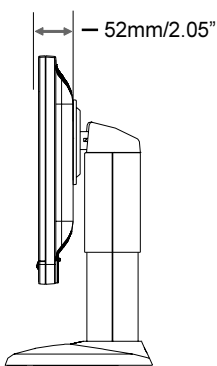

Side View

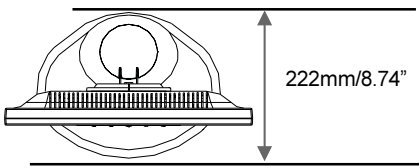

Top View

Compatibility Modes

Mode	Resolution	Frequency (Hz)	H. Frequency (kHz)
IBM VGA	640 x 350	70	31.5
IBM VGA	640 x 400	70	31.5
IBM VGA	640 x 480	60	31.5
IBM VGA	720 x 400	70	31.5
VESA VGA	640 x 480	72	37.9
VESA VGA	640 x 480	75	37.5
VESA SVGA	800 x 600	56	35.2
VESA SVGA	800 x 600	60	37.9
VESA SVGA	800 x 600	72	48.1
VESA SVGA	800 x 600	75	46.9
VESA XGA	1024 x 768	60	48.4
VESA XGA	1024 x 768	70	56.5
VESA XGA	1024 x 768	75	60.0
VESA SXGA	1280 x 1024	60	64.0
VESA SXGA	1280 x 1024	75	80
Apple Mac LC	640 x 480	67	34.9
Apple Mac II	640 x 480	67	35.0

Pivot Software Installation

Follows are the procedures for pivot software set up.

1. Insert the Pivot Pro CD-ROM into the CD-ROM driver.
2. Run the Start_Pivot program and select the pivot option to install portrait displays' software on your computer.
3. Restart your computer. To Change orientation, right click anywhere on the desktop and select Rotate 0, 90, 180, or 270 from the menu. Now hold the edges of your display and rotate it.
4. Start exploring the benefits of your new portrait monitor. Web pages, E-mail, reports and letters are best viewed in portrait orientation. They can be viewed and edited without the need to scroll the page.

Planar Systems, Inc.

Customer Service

24x7 Online Technical Support: <http://www.planar.com/support>

1195 NW Compton Drive
Beaverton, OR 97006-1992

Tel: 1-866-PLANAR1 (866) 752-6271

Email: PlanarSupport@planar.com

Hours: M-F, 5am - 5pm Pacific Time

© 2005 **Planar Systems, Inc. 03/05** Planar is a registered trademark of Planar Systems, Inc.
Other brands and names are the property of their respective owners.
Technical information in this document is subject to change without notice.