

## Important Safety Instructions

- Read the Safety Instructions carefully and keep it for later use.
- Be aware of all warnings and instruction signs marked on the products.
- When cleaning, cut off the electrical supply at all times. Never use liquid or aerosol detergent, use a damp rag instead. For more details, please refer to P.4 'Cleaning the Monitor.'
- Always keep the product away from heavy moisture.
- Keep this product stable all times. The product may fall causing serious damage.
- Do not clog apertures on the bezels used for ventilation purpose. Do not install this product in poor ventilated areas. Always keep this product away from all kinds of heat sources.
- The power source used for this product must match one marked on the product's label. Please consult your dealer if you have any doubt.
- In order to avoid electric shock, a 3-wire plug with a grounding pin is provided. Do not use any kind of plug without grounding.
- Do not lay the power cord on the pathway or rest anything heavy on it.
- Do not insert objects or pour liquid into this product through apertures on bezels. It may touch a high voltage area causing an electric shock or short circuit.
- Do not attempt to repair the product by yourself. It may expose you to electric shock. Contact a dealer near you for service.
- Do not unplug the power cord under the following circumstances. A qualified field service electrician is needed.
  - When the power cord is damaged or frayed.
  - If liquid has been poured into the product.
  - If the product has been exposed to rain or heavy moisture.
  - If the product can't be adjusted and operated properly by following the operating instructions. Intent to do more advanced adjustments may result in extensive work for field service electrician.
  - If the product has been dropped or the casing is broken.
  - If there is a dramatic change of the performance.
- A proper type of power cord has been selected according to the safety of destination and must be used to prevent electric shock.

PL171M

# Contents

**Note:** To access our Users Guide Homepage (Page 2) at anytime, simply click on the below Homepage icon or use the arrow icon(s) to browse through each page. When in Homepage, clicking on your desired topic will automatically open each page.

Important Safety Instructions.....	1
<b>Getting Started.....</b>	<b>3</b>
Package Contents .....	3
Unique Features .....	3
Precautions.....	4
Cleaning the Monitor.....	4
Adjusting the Monitor.....	5
Quick Installation .....	6
<b>Operations.....</b>	<b>7</b>
Function Key.....	7
Hot Key .....	7
OSD Main Menu .....	8
COLOR Sub-Menu .....	9
LCD-Adjust Sub-Menu.....	9
MISC Sub-Menu .....	10
<b>Technical Data .....</b>	<b>12</b>
Specifications.....	12
Factory Preset Timings.....	13
Power Management System .....	13
<b>Appendix .....</b>	<b>14</b>
FCC Information .....	14
Power Cord Safety Precautions .....	14
<b>Planar Customer Service Contact Information.....</b>	<b>15</b>

## Getting Started

Congratulations on your purchase of this TFT LCD Monitor. Please read this section carefully to get instant understanding of this product and its correct operations.

***Important! Please keep the original carton and all packing materials for future shipping needs.***

## Package Contents

Your TFT LCD Monitor package includes the following items:

- 17" TFT LCD Color Monitor
- Signal cable with 15 pin D-Sub connector
- Signal cable with 24 pin DVI-D connector
- Adaptor
- Power cord
- Audio cable
- User's Guide

## Unique Features

- Supports up to 16.7 Million colors.
- High brightness & high contrast, providing more vivid images.
- Built-in both analog and digital interfaces
- TCO'99 and TCO'95 (option) approved.
- Composite sync and sync on green (SOG) compatibility.
- Five languages in OSD (On Screen Display).
- 10-stage smoothing function.
- Supports 19 sets of factory preset modes and 13 sets of user's automatically saved modes.
- Ultra-slim design, only 7 cm in thickness more space saving.

## Precautions

- Sit at least 18"(45 cm) away from the screen when in use.
- Do not press on the LCD panel as it is very fragile.
- Do not touch the LCD panel with your bare hands. Oil from your skin is difficult to remove and may damage the screen.
- Do not expose the LCD monitor directly under sunlight or other heat sources. When in use, the LCD screen should be facing away from light sources to reduce glare.
- It is important to choose a well-ventilated area to place your LCD monitor for adequate ventilation. Do not place anything on top of the LCD monitor.
- Ensure the areas around the LCD monitor are clean and moisture-free.
- Do not place heavy objects on the power cord, adapter, or signal cables.
- If smoke, abnormal noise, or strange odor occurs, immediately turn the LCD monitor off and call your dealer. Do not continue using the LCD monitor.
- Do not remove the rear cover by yourself. The display unit contains high-voltage parts and may expose you to the electric shock. Contact your local dealer for the service if needed.
- When moving, always handle your LCD monitor with care.
- Do not forcefully press down the screen in case of damages to the monitor. Please refer to P.5 to adjust the monitor.

## Cleaning the TFT LCD Monitor

- Wipe screen gently with a clean lens brush of camel hair, or a soft, clean, lint-free cloth. It can remove dust and other particles which will not scratch the LCD panel.
- If it is still not clean, blow and wipe gently with a soft, clean, lint-free cloth.
- ***Never pour or spray any liquid onto the LCD monitor.***
- ***Do not apply pressure to the LCD panel.***

## Adjusting the Monitor

- Press down on the stand and gently adjust the monitor to a suitable viewing angle (see Figure below). Please note that this monitor can only be tilted forward to 5 degree and backward to 20 degrees. To prevent damage to the monitor, do not press the screen over its tolerant angles.

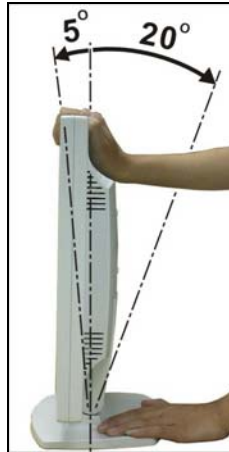

## Quick Installation

- Make sure the computer is turned off.
- Attach the female end of the power cord (Indication F) to the adapter (Indication E), then plug the adapter connector to the power “DC-IN (Indication A)” jack of the LCD monitor.
- When using a power cord, plug the male end into the wall socket.
- Plug one end of the 15 pin D-Sub signal cable (Indication G) in the “ANALOG” video signal connector (Indication B) of LCD monitor. If you use digital signal, plug one end of the 24 pin DVI-D signal cable (Indication H) in the “DIGITAL” video signal connector (Indication C) of LCD monitor.
- When using an audio cable, plug one end of the cable in the “AUDIO” jack of the LCD monitor, and plug the other end in the jack of the sound card.
- Turn on the computer.
- Turn on the LCD monitor.
- Before your operations of the monitor, please refer to P.7 “Operations” first.

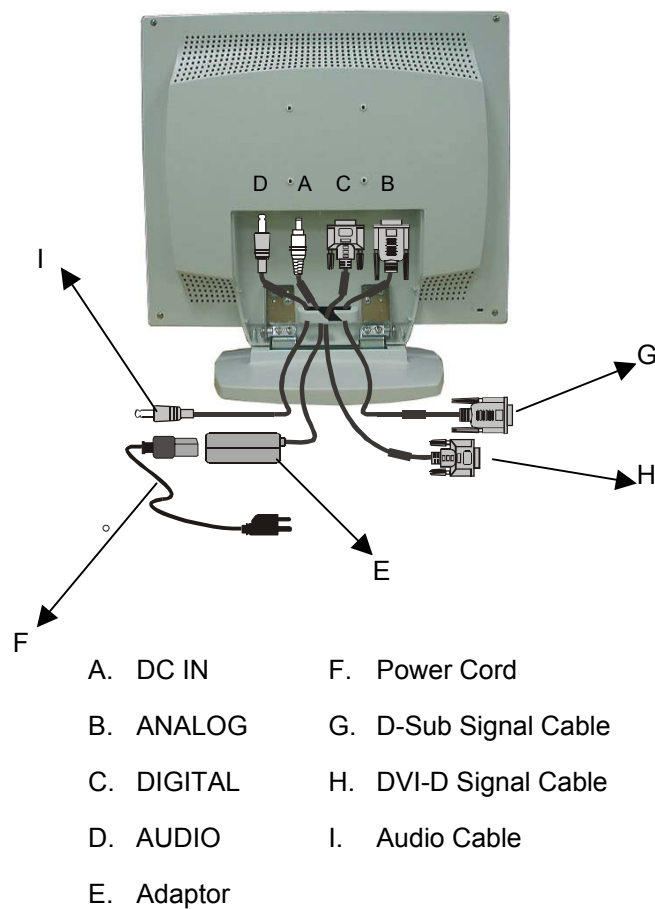

## Operations

Push the power button (Indication E) on the front of the LCD monitor to turn it on. When the power light (Indication F) turns green, the LCD is ready to use. Push the power switch button to turn off.

## Function Keys

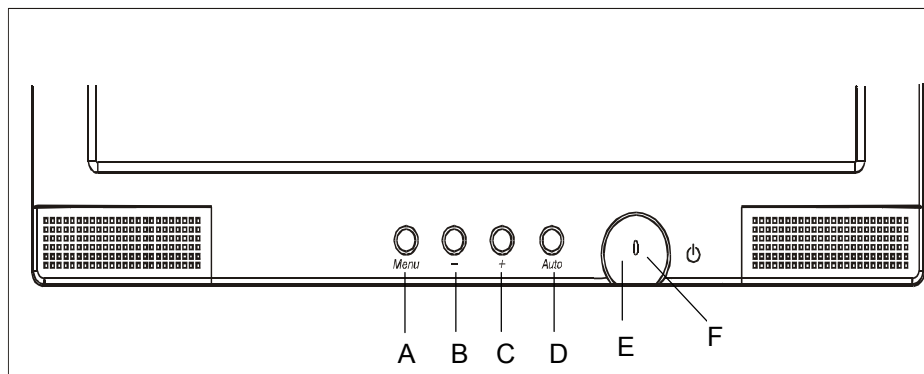

- |                 |  |
|-----------------|--|
| A. Menu         | 1. Press this button to turn on/off the OSD (On Screen Display) main menu.     |
|                 | 2. Press this button to activate selected items.                               |
| B. [-]          | 1. To scroll down the menu.  |
|                 | 2. To decrease the value of selected item.                                     |
| C. [+]          | 1. To scroll up the menu.  |
|                 | 2. To increase the value of selected item.                                     |
| D. Auto         | Press this button to activate "AUTO SYNC", "AUTO-CONTRAST" and "BRIGHTNESS".   |
| E. Power switch | Press this button to turn on/off the monitor.                                  |
| F. Power LED    | When the light is green, the power is on; orange when the power is active off. |

## Hot Keys

**Audio:** When OSD menu is not displayed, press the [-] button to activate audio function. Press the [+] button to increase volume, [-] button to decrease volume shown below. Press [Menu] to exit the Audio window.



- **Auto:** Press the [Auto] button to activate Auto-Sync, Auto-Contrast and Brightness under any circumstances.

## OSD Main Menu

For screen adjustments, press the [Menu] button to display the OSD (On-Screen Display) Main Menu shown below. Press the [+] or [-] button to scroll up or down the menu to your required options. Please note that the OSD will automatically turn off in 30 seconds without any manipulation or by simply pressing the [Menu] button for 2 seconds.

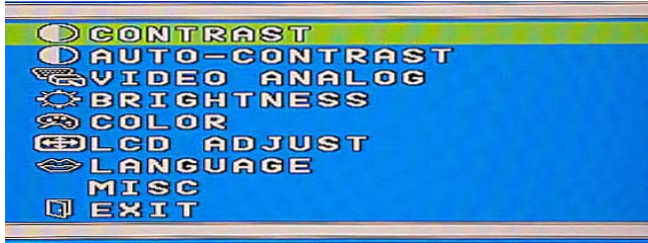

**CONTRAST** Adjusts the contrast level of the screen image. Under Main Menu, select CONTRAST using the [+] or [-] button, then press [Menu] button to activate the function. Press the [+] button to increase contrast, [-] button to decrease contrast shown below. Press [Menu] to return to Main Menu.



**AUTO-CONTRAST** Automatically adjusts the contrast level of screen image. Press [+] or [-] button to select AUTO CONTRAST, then press [Menu] button to activate AUTO CONTRAST.

**VIDEO ANALOG/DIGITAL** Switches between analog and digital input signal. Press [+] or [-] button to select VIDEO ANALOG, then press [Menu] button to switch between video inputs.

**BRIGHTNESS** Adjusts the brightness level of screen image. Under the Main Menu, select BRIGHTNESS using [+] or [-] button, then press [Menu] button to activate the function. Press the [+] button to increase the brightness, [-] button to decrease the brightness shown below. Press [Menu] to return to main menu.





## **COLOR Sub-Menu**

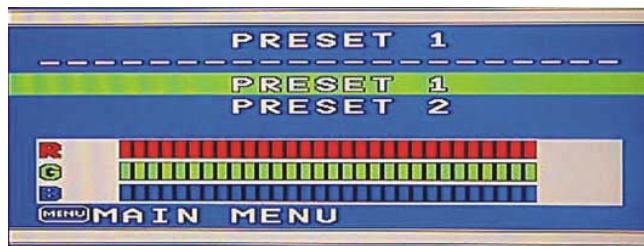

- Under the Main Menu, select COLOR using the [+] or [-] button, then press [Menu] button to activate the COLOR Sub-Menu shown as above.
- Under the COLOR Sub-Menu, press [+] or [-] button to scroll up or down to your desired preset color mode. Then press [Menu] to activate the mode.
- Or you may choose user's mode by adjusting R, G, B respectively. Press the [+] or [-] button select R or G or B bar, then press [Menu] to activate the adjustment. Press the [+] or [-] button to adjust the values, then press [Menu] button to save the value and return to color Sub-Menu to adjust another color. After adjusting R, G, B colors, press [Menu] to turn off the OSD menu or go to MAIN MENU to return to OSD Main Menu.

**MENU MAIN MENU** Returns to OSD main menu. Press [+] or [-] button to select MAIN MENU, then press [Menu] button to return to OSD Main Menu.

## **LCD ADJUST Sub-Menu**

Under the Main Menu, select LCD ADJUST using the [+] or [-] button, then press [Menu] button to enter LCD ADJUST Sub-Menu.





**PC/MAC** Switches between PC at 800X600 resolution and MAC at 832X624 resolution. Select PC/MAC, using [+] or [-] button. Then press [Menu] to initiate the switch between PC and MAC shown as above.

**H SIZE** Adjusts the width of the screen image. Select H-SIZE, using [+] or [-] button, then press [Menu] button to activate the function. Press [+] button to increase the width of the screen image, press [-] button to decrease the width of the screen image shown below. Press [Menu] to return to LCD ADJUST Sub-Menu.

 **H-POSITION** Moves the screen image to the right or left. Select H-POSITION using the [+] or [-] button, then press the [Menu] button to activate the function. Press [+] button to move the screen to the right, [-] button to move to the left. Press [Menu] to return to LCD ADJUST Sub-Menu.

 **V-POSITION** Moves the screen image up or down. Select V-POSITION using the [+] or [-] button, then press [Menu] to activate the function. Press [+] button to move the screen image up, [-] button to move down. Press [Menu] to return to LCD ADJUST Sub-Menu.

 **FINE TUNE** Aligns the performance slightly. Select FINE TUNE using the [+] or [-] button, then press [Menu] button to activate the function. Press [+] or [-] button until the screen image looks crisp, sharp and focused. Press [Menu] to return to LCD ADJUST Sub-Menu after alignment.

 **AUTO-SYNC** Automatically adjusts the image to the best performance. Press [+] or [-] button to select AUTO SYNC, then press [Menu] button to activate AUTO SYNC.

**NOTE:**

- *When setting up this monitor for the first time, perform AUTO-SYNC before use.*
- *To perform AUTO-SYNC, first display an image that makes the entire screen very bright. It is better to perform AUTO-SYNC under WINDOWS.*

 **LANGUAGE** Selects the preferred language used in the OSD menus. Under Main Menu, scroll to Language using [+] or [-] button, then press [Menu] button to activate the function. Press [+] or [-] button to choose preferred Language, then press [Menu] button to save selection and exit OSD or go to MAIN MENU to return to OSD Main Menu.





## MISC Sub-Menu

Under the Main Menu, select MISC using the [+] or [-] button, then press [Menu] button to enter MISC Sub-Menu.





 **H-OSD POSITION** Moves the OSD position on the screen to the right or left. Select H-OSD POSITION using [+] or [-] button, then press [Menu] button to activate the function. Press the [+] button to move the OSD position to the right, [-] button to move left. Then Press [Menu] to return to MISC Sub-Menu after adjustment.

 **V-OSD POSITION** Moves the OSD position on the screen up or down. Select V-OSD POSITION using [+] or [-] button, then press [Menu] button to activate the function. Press the [+] button to move the OSD position up, [-] button to move down. Then Press [Menu] to return to MISC Sub-Menu after adjustment.

 **SMOOTHING** Adjusts displayed text to be smoother. Select SMOOTHING using [+] or [-] button, then press [Menu] button to activate the function. Press [+] or [-] button and adjust to your liking shown below. Press [Menu] button to return to MISC Sub-Menu.



 **INVISIBLE** Activates the OSD background to be invisible. Select INVISIBLE using the [+] or [-] button, then press [Menu] button to select either On or Off option. Press the [+] or [-] button to return to the MISC Sub-Menu.

 **INFORMATION** Displays the timing mode (video signal input) coming from the graphics card in the computer. Select INFORMATION using the [+] or [-] button, then press [Menu] to display the mode shown below. Then press [Menu] button to exit OSD or go to MISC to return to MISC Sub-Menu.



 **RECALL** Returns the adjustments back to factory settings if the monitor is not operating at its original factory settings. Select RECALL using the [+] or [-] button, then press [Menu] button to reset the settings.

 **EXIT** Turns off the OSD. Select EXIT using the [+] or [-] button, then press [Menu] to exit the OSD.

## Technical Data

### Specifications

<b>LCD</b>	Size Type Color Glass surface	17.0" (full 17.0" viewable diagonal area) Color TFT Active Matrix Panel (Thin Film Transistor) Supports up to 16.7M Haze 25%, Hard-Coating (3H)
<b>Input Signal</b> <b>Video Sync</b>	Video Sync	RGB Analog H. V. Separate Sync, H.V. Composite Sync (TTL Compatible), Sync on Green, H.F.: 30-80kHz, V.F.: 55-75Hz, Video Bandwidth: 135MHz
<b>Compatibility</b>	PC Macintosh®	Up to 1280 x 1024 Power Macintosh® up to 1280 x 1024
<b>Viewing Angle</b>	Horizontal Vertical	150° 125°
<b>Resolution</b> <b>Brightness</b> <b>Contrast</b>	Primary Mode	VESA 1280 x 1024 @ 60Hz 250 cd/m <sup>2</sup> (Typ.) 350:1 (Typ.)
<b>Power</b>	Voltage	AC100-240 VAC, 50-60Hz, 12VDC Adapter
<b>Connector</b>	Input Signal	Analog: 15 pin D-sub Connector Digital: 24 pin DVI-D Connector
<b>Display Area</b>	Full screen	337.920 mm (H) x 270.336 mm (V)
<b>Operating Conditions</b>	Temperature Humidity Altitude	32 F to 104 F (0 °C to 40 °C) 10% to 90% (non-condensing) to 10,000 feet
<b>Storage Conditions</b>	Temperature Humidity Altitude	-4 F to +140 F (-20 °C to +60 °C) 10% to 90% (non-condensing) to 40,000 feet
<b>Dimensions</b>	Physical  Package	393.2 mm (H) x 400.4 mm (W) x 180.0 mm (D) 15.48" (H) x 15.76" (W) x 7.09" (D) 482.0 mm (H) x 456.0 mm (W) x 225.0 mm (D) 18.98" (H) x 17.95"(W) x 8.86" (D)
<b>Weight</b>	Net Gross	6.00 kg (13.22 lbs) 8.20 kg (18.06 lbs)
<b>Regulations</b>	Safety EMI Low Radiation EMC Energy Star Quality Environment	UL, cUL, TUV/GS(option), CB Report FCC DoC, VCCI B, CISPR 22 B, BSMI MPR 1990:10, TCO99 CE EPA, NUTEK SEMKO Power Down, Energy 2000 SEMKO Ergonomics, TUV/Ergo. TCO99, TCO95
<b>Power saving</b>	On Off	47W (green LED) (Typ.) 3W (orange LED)
<b>Audio</b>	Speakers	2WX2

- All products and trademarks are brand names of their respective companies.
- Specifications are subject to change without prior notice.

## Factory Preset Timings

Timing	Horizontal Frequency (KHz)	Vertical Frequency (Hz)	Sync Polarity (H/V)
VGA 640 X 350	31.470	70.089	+ / -
VGA 720 X 400	31.467	70.082	- / +
VGA 640 X 400	31.469	70.087	- / +
VESA 640 X 480	31.469	59.940	- / -
VESA 640 X 480	37.861	72.809	- / -
VESA 640 X 480	37.500	75.000	- / -
VESA 640 X 480	35.000	66.667	Composite
VESA 800 X 600	35.156	56.250	+ / +
VESA 800 X 600	37.879	60.317	+ / +
VESA 800 X 600	48.077	72.188	+ / +
VESA 800 X 600	46.875	75.000	+ / +
VESA 832 X 624	49.715	74.535	Composite
VESA 1024 X 768	48.363	60.004	- / -
VESA 1024 X 768	56.476	70.069	- / -
VESA 1024 X 768	58.036	71.916	- / -
VESA 1024 X 768	60.023	75.029	+ / +
VESA 1024 X 768	60.241	74.927	Composite
<b>VESA 1280 X 1024</b>	<b>63.981</b>	<b>60.020</b>	<b>+ / +</b>
VESA 1280 X 1024	79.976	75.025	+ / +

## Power Management System

This monitor matches VESA® DPMS™ (Display Power Management Standard) Standards. For the monitor's power saving features to work, the video board or computer must also match VESA DPMS standards. The Off state means the monitor is in the lowest DPMS state with the highest power savings.

## Appendix

### FCC Information

This equipment has been tested and found to comply with the limits for a Class B digital device, pursuant to part 15 of the FCC Rules. These limits are designed to provide reasonable protection against harmful interference in a residential installation. This equipment generates, uses, and can radiate radio frequency energy, and if not installed and used in accordance with the instructions, may cause harmful interference to radio communications. However, there is no guarantee that interference will not occur in a particular installation. If this equipment does cause harmful interference to radio or television reception, which can be determined by turning the equipment off and on, the user is encouraged to try to correct the interference by one or more of the following measures:

- Reorient or relocate the receiving antenna.
- Increase the separation between the equipment and receiver.
- Connect the equipment into an outlet on a circuit different from that to which the receiver is connected.
- Consult the dealer or an experienced radio/TV technician for help .

### FCC Warning

To assure continued FCC compliance, the user must use the provided grounded power supply cord and the provided shielded video interface cable with bonded ferrite cores. Also, any unauthorized changes or modifications to this TFT LCD would void the user's authority to operate this device.

### Power Cord Safety Precautions

**Caution:** Use a power cable that is properly grounded. Always use the AC cords listed below

for each area:

USA ..... UL

Canada ..... CSA

Germany ..... VDE

Switzerland ..... SEV

Britain ..... BASEC/BS

Japan ..... Electric Appliance Control Act

Use an AC cord in other areas that meets local safety standards.

## **Planar Systems, Inc**

Customer Service

**E-mail:** [desktopmonitors@planar.com](mailto:desktopmonitors@planar.com)

**Tel:** 1-866-PLANAR-1 (1-866-752-6271)

**Hours:** M-F, 7am - 6pm Pacific Time

**Customer Service Online Support:** <http://planar.custhelp.com>

© 2002 **Planar Systems, Inc. 05/02** Planar is a registered trademark of Planar Systems, Inc.

Other brands and names are the property of their respective owners.

Technical information in this document is subject to change without notice.