

Product Manual
PDP 42"

PLASMA DISPLAY



PLANAR

· Safety precautions

⚠ Power Supply - Warning

AC plug should not be touched with wet hands. It may cause an electric shock.

- It can cause an electrical shock.



Do not use damaged electric cord/ plug, or loose outlet.

- It can cause an electric shock or a fire.



Do not use multiple devices in an outlet at the same time to avoid the overload.

- It may cause a fire due to overheating from the outlet.



⚠ Power Supply - Warning

Fully insert the plug into the outlet.

- If the connection is unstable, it may cause a fire.



Be careful not to forcibly bend the electric cords or press them with a heavy object.

- It may cause an electric shock or a fire.



Be sure to ground the PDP power source.

- It may cause an electric shock if it has a failure or electrical leakage. Only use the proper power cord supplied with PDP and connect it to an outlet with a ground terminal.

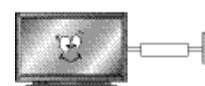

⚠ Power Supply - Caution

When unplugging the AC cord, pull out by holding the plug itself and not by pulling on the cord.

- If the power cord is damaged, it may cause a fire.



This manual describes how to operate the PDP properly and safely. Please read this manual carefully. This manual should be retained for future reference.



⚠ Warning : Serious injury or fatal injury may occur, if the indicated warning is not followed.

⚠ Caution : Minor injury or product damage may occur, if the indicated caution is not followed.

⚠ Installation - Warning

Do not place any liquid and foreign objects on or above the PDP.

- It may cause an electric shock and a fire. Contact your dealer for service.

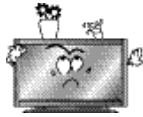

Do not install the PDP where water (rain) drops can enter the enclosure, or where there is oil or humidity.

- It may cause an electric shock, a fire, failure or transformation.

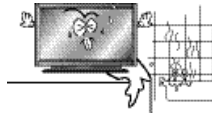

Do not use or keep it in a place where combustible sprays or inflammable materials are kept.

- It may cause an explosion or a fire.

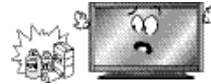

Do not install the PDP in an unstable location with a smaller support area than the PDP. It may fall and cause injury.

- It should be installed on a flat, stable location.

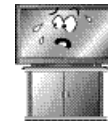

⚠ Installation - Warning

Do not put candles, mosquito incense, cigarette lighters, a heater, or any other source of heat on or near the PDP.

- It may cause a fire.

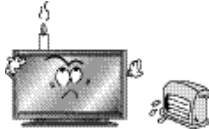

Do not install in poorly ventilated locations such as bookcases or closets.

- It may cause a fire due to high temperature.

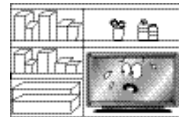

Do not place the electric cord or the plug near an electric heater.

- The coating on the electric cords and the plug may melt and cause a fire or an electric shock.



Install the antenna firmly and away from high-voltage wires and communication cables.

- If the antenna touches the high-voltage wire, it may cause an electric shock or a fire.



⚠ Installation - Caution

The PDP should be installed a small distance away from walls or other solid objects in order to maintain ventilation and to prevent heat damage.

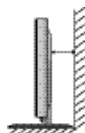

Blockage of the ventilator with table covers or curtains can cause a fire due to the increased temperature inside the monitor.



Be sure to install the monitor on a level surface.

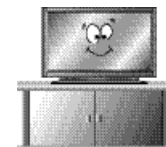



· Safety precautions

⚠ Usage and Maintenance - Warning

During a thunderstorm, unplug the power cord and never touch the antenna cable.

- It can cause an electric shock or a fire.



Do not insert any foreign objects such as wires and drills into the PDP ventilation slots or the AV terminal.

- It may cause an electric shock or a fire.

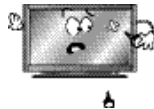

Do not allow children to play with the PDP.

- It may fall or flip over and may cause serious injury.



Never attempt to disassemble, repair or modify the PDP.

- It may cause an electric shock or a fire. If it requires repair, contact your dealer.

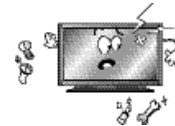

⚠ Usage and Maintenance - Caution

When removing the batteries in the remote control, please place the batteries in a location out of children's reach. It must be disposed properly.



Unplug the PDP if you do not intend to use it for a long time. The generation of heat, insulation degradation or the accumulation of dust may cause an electric fire.

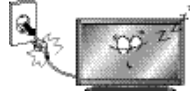

When moving the PDP, turn off the power switch and unplug the power cord from the outlet. Make sure that the external connection cords are unplugged (such as antenna cable and input cables) prior to moving.

- The electrical cords may get damaged and cause an electric shock or a fire.

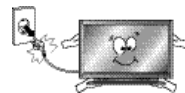

If the PDP is emitting smoke or an unusual smell, immediately turn off the power and unplug the power cord.

- It may cause an electric shock or a fire. Contact your dealer for the service.



When transporting the PDP, at least two people should carry it. If it is dropped, serious injury may occur.



The plugs and connectors must be free of dust or water before use. It may cause an electric shock or a fire.



To clean the interior of the PDP, contact your dealer for service. A fire or failure may occur, if it is not cleaned.



When cleaning the PDP, unplug the electric cord and wipe with a soft and dry cloth. Never clean with chemicals such as industrial glaze, wax, benzene, alcohol, thinner, aromatic, lubricant, detergent, or a damp cloth.

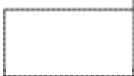
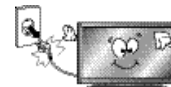

Considerations for Usage

Still image (immovable) screen may cause permanent damage to PDP.

1. Lengthy display of still images from video games, banners, graphics and others may fatally damage the screen.
2. When using Picture-In-Picture, permanent damage may occur if the sub-image screen stays on the corner of screen for a long time.
3. When using the PDP in 4:3 formats with sidebars for a long period of time, it may cause damage to the plasma panel. It is recommended that you use 16:9 or Panorama format. (Image burn-in can be avoided by using "Panel Protection" function or a screen-saver. However, once image burn-in occurs, it may not disappear completely. An image will be dimmed as the image is displayed long time or repeatedly.)

Any damage to the PDP caused by improper usage (such as image burn-in) shall not be covered by the warranty.

Defective pixels that can be seen on PDP screen. (illuminated spots, bright spots, scotoma, blind spot, blinking)

Generally, PDP consists of about 1.22 million pixels and having defective pixels is possible. A PDP with a number of defective pixels below a certain number is not considered defective. The limited number of defective pixels does not affect the performance or reliability of the PDP. The standard of inspection regarding defective pixels is the same or better as the competitor's offering on similar PDP. It is not subject to replacement or a refund. We will do our best to minimize the defective pixel as best as we can.



**The ONLY Plasma Screens To Feature
Emmy® Award Winning Faroudja Video**



Directional Correlational Deinterlacing, known as DCDI™, is state-of-the video processing technology invented and patented by Faroudja, a division of Genesis Microchip Inc. Faroudja is a world leader in innovative high-performance video processing and creator of Emmy® Award winning technology with over 30 years of experience.

DCDI™ was designed for video based material like fast-paced sporting events. Its purpose is to eliminate jagged edges along diagonal lines caused by interpolation and achieves this by monitoring edge transitions, intelligently filling in the gaps.

· Safety precautions	
- Power Supply	2
- Installation	3
- Usage and Maintenance	4
· Considerations for Usage	5
· Contents	6~7
User Guidance Information	
· Names of each part	8~9
· Options	10
· Accessories	11
· Installing the PDP	
- Installing on a wall	12
- Installing on a desktop	13
· Remote controller	
- Functions of remote controller buttons	14
- Inserting batteries into remote controller	15
Connection	
· Connecting to the VCR	16
· Connecting to the Cable TV	17
· Connecting to the Camcorder/ Video game console	18
· Connecting to the DVD player	19
· Connecting to the DTV receiver	20~21
· Connecting to the PC	22~23
Basic Use	
· Powering the PDP	24
· Selecting input source	25
· Volume.....	26
· Mute	26

· Still	26
· Info	26
· Menu	27
Application	
· PSM (Picture Status Memory)	28
· Adjusting the screen in USER mode	29
· ARC (Aspect Ratio Control)	30
· Watching PIP	31
· PC mode	32 - 33
· Color Tone (Pre-Set)	34
· Color Tone (Manual adjustment)	35
· SSM (Sound Status Memory)	36
· Equalizer	37
· Stereo	38
· Reset	39
· Language	40
· Half Tone	41
· Panel Protection	42
· PBP Mode	43
· Current Time setting	44
· On Time/ Off Time (Time setting)	45
· On Time Volume	46
· Sleep Timer	47
Maintenance and Service Part	
· Trouble shooting	48 - 50
· Supporting display mode	51
· Specifications	52
· User Information	

User Guidance
Information

Connection

Basic Use

Application

Maintenance and
Service Part

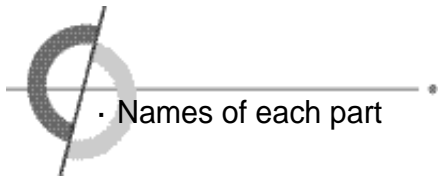

Front View

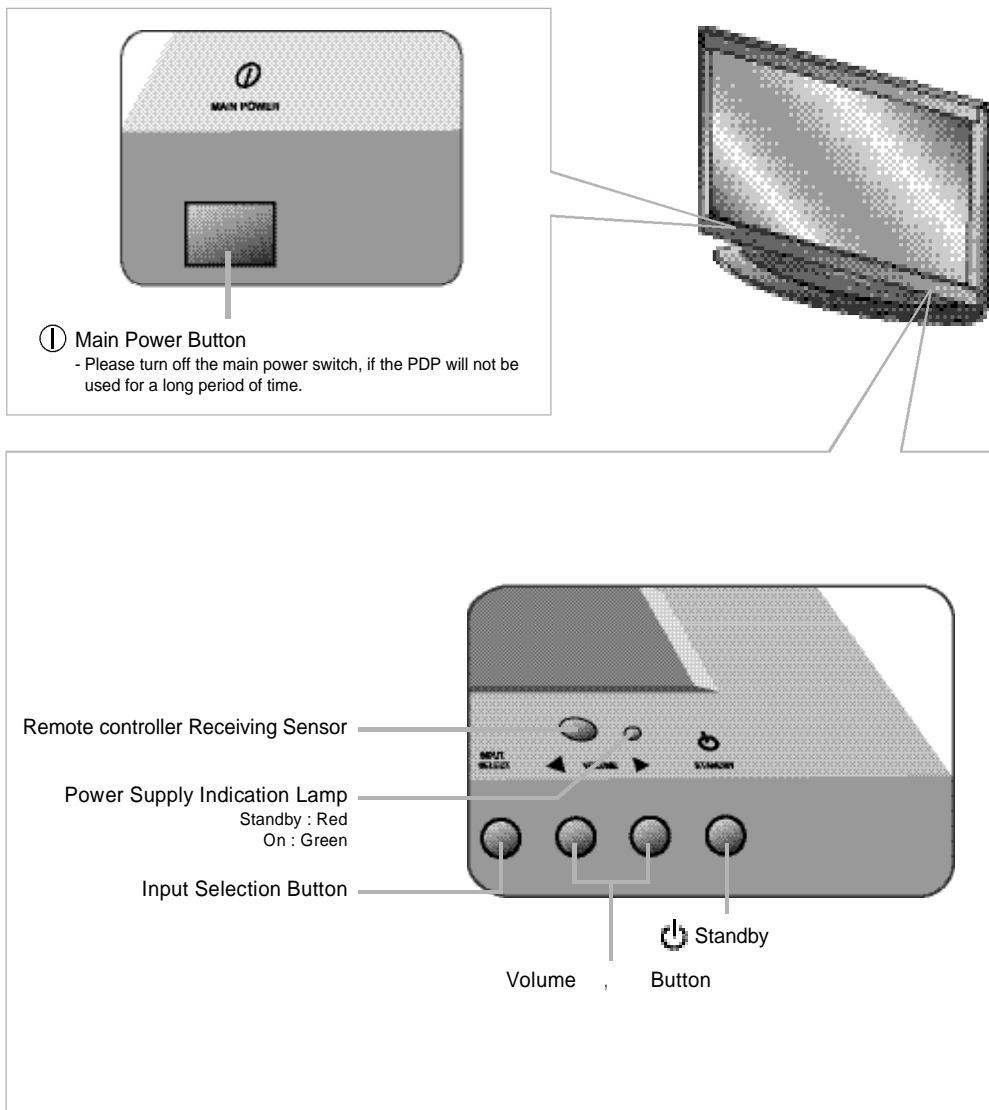

Back View

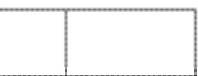
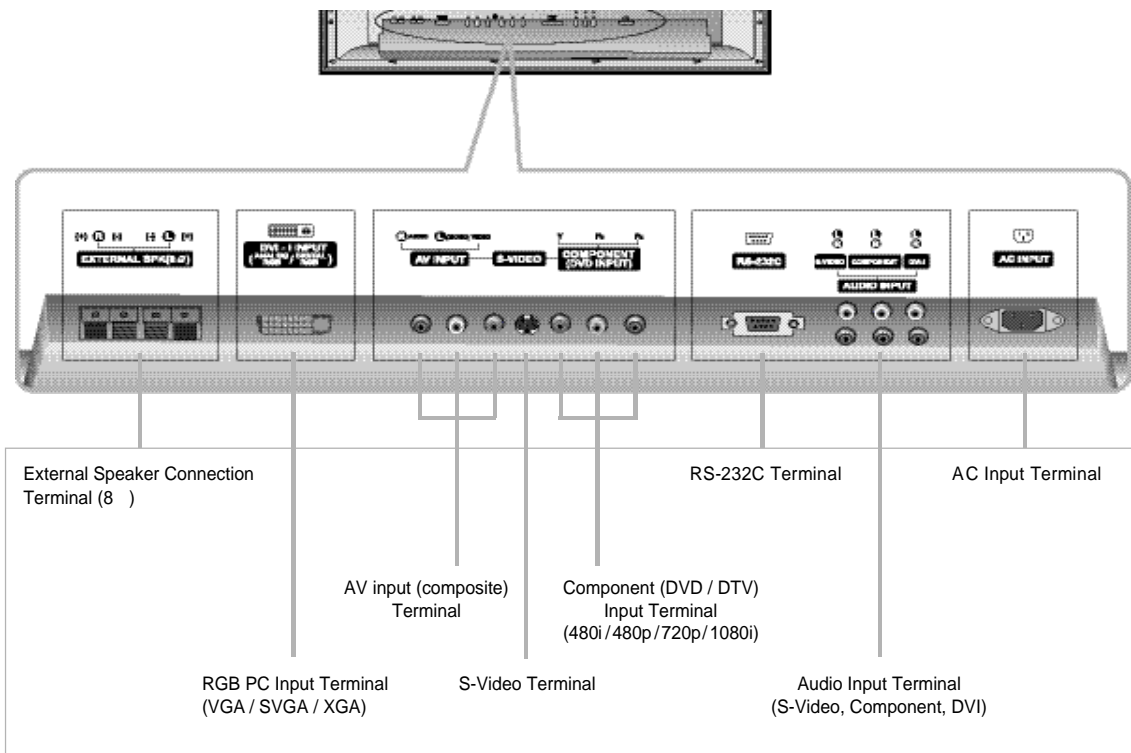

Options

To improve the quality of the PDP, specification is subject to change without notice. Please contact your dealer for current options available.

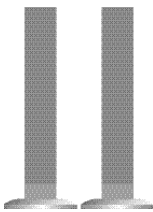

Speaker

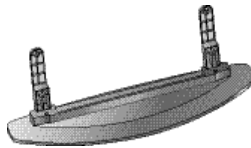

Desktop Stand

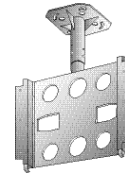

Ceiling - Mount
Bracket

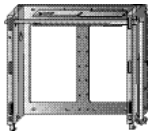

Adjustable - Angle
Wall mount



Audio Cable



Accessories

The configuration of the components may look different from the following illustration.



RGB Cable



User's Manual

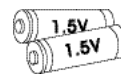

Battery 1.5V(AAA x 2)



Power Cord



Remote Controller



DVI Adapter



Video Cable : U.S.A only



Scart - RCA Cable
: Europe only
: Middle East only

· Installing the PDP

Installing on the wall



You can install PDP in wall-mounted style as shown in the figure above.

Things to consider

- Please secure enough space for safe use. (Please refer to A and B.)
- Installation of the PDP in an improperly ventilated location can cause a fire or damage to the PDP due to increased temperature.

A →
(Usage of wall-mount)

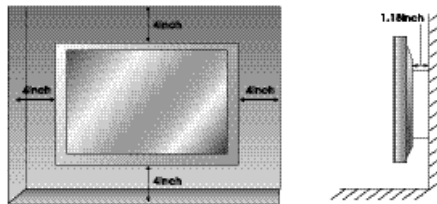

Contact your dealer to purchase the "Adjustable-angle wall mount" required for wall-mounted installation.

Installing on a desktop

- This is not floor-standing unit.

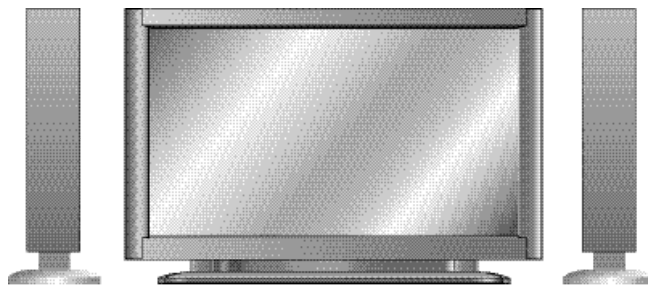

You can install PDP in a desktop style as shown in the figure above.

Things to consider

- Do not install on an unstable location with support area smaller than the PDP.
- Please refer to the desktop stand user's manual for details of installation.

B →
(Usage of stand)

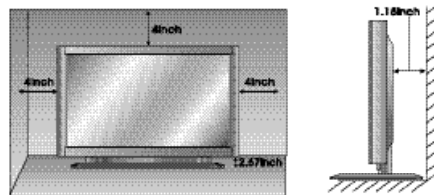

Please contact your dealer to purchase the "speakers".

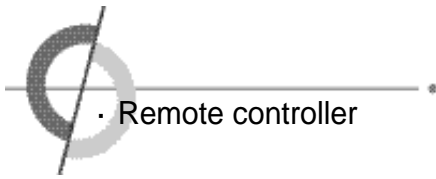

Remote controller

Functions of remote controller buttons

The remote controller is using Infra-Red (IR). Point it towards the front of the PDP. The remote controller may not work correctly if it is operated out of range or out of angle.

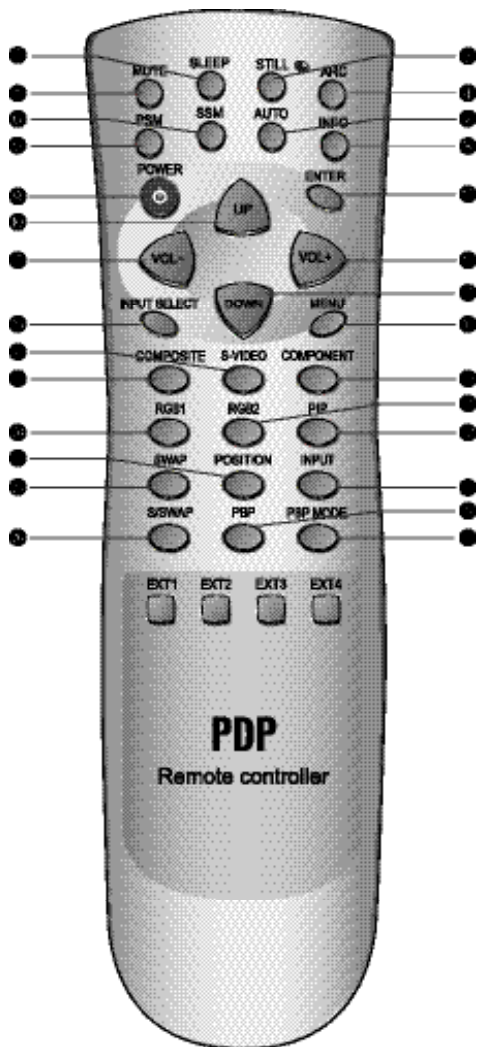

- ① MUTE : SOUND MUTE KEY
- ② SLEEP : SLEEP TIMER KEY
- ③ STILL : FREEZE KEY
- ④ ARC : ASPECT RATIO CONTROL KEY
(4 : 3, 16 : 9, Zoom, Panorama)
- ⑤ PSM : PICTURE STATUS MEMORY KEY
(Standard, Dynamic, Movie, Mild, Game, User)
- ⑥ SSM : SOUND STATUS MEMORY KEY
(Standard, Music, Movie, Speech, User)
- ⑦ AUTO : RGB1(ANALOG RGB) INPUT SIGNAL ADJ
- ⑧ INFO : INFORMATION DISPLAY KEY
- ⑨ POWER : POWER ON/OFF KEY
- ⑩ UP : MENU CONTROL KEY
- ⑪ DOWN : MENU CONTROL KEY
- ⑫ VOL- : VOLUME - OR MENU CONTROL KEY
- ⑬ VOL+ : VOLUME + OR MENU CONTROL KEY
- ⑭ ENTER
- ⑮ INPUT SELECT : MAIN INPUT SOURCE SELECT KEY
- ⑯ MENU : OSD MENU DISPLAY KEY
- ⑰ COMPOSITE : COMPOSITE INPUT SELECT KEY
- ⑱ S-VIDEO : S-VIDEO INPUT SELECT KEY
- ⑲ COMPONENT : COMPONENT INPUT SELECT KEY
- ⑳ RGB1 : ANALOG RGB INPUT SELECT KEY
- ㉑ RGB2 : DIGITAL RGB INPUT SELECT KEY
- ㉒ PIP (ON/OFF, SIZE LARGE/ SMALL/PBP)
: PIP ON/OFF AND PIP SIZE (LARGE/ SMALL/PBP) CONTROL KEY
- ㉓ SWAP : PIP SWAP KEY
- ㉔ POSITION : PIP POSITION SELECT KEY
- ㉕ INPUT : PIP INPUT SELECT KEY
- ㉖ S/SWAP : SOUND SWAP KEY
- ㉗ PBP : PBP ON/OFF KEY
- ㉘ PBP MODE : PBP MODE CONTROL KEY (16 : 9 / 4 : 3)

If remote controller does not work

1. Check the polarity (+,-) of the batteries in the remote controller.
 2. Check that the batteries have power.
 3. Check that the PDP is powered and that it is properly plugged in.
 4. Check if any three-wavelength lamp, special fluorescent or neon sign is turned on near the PDP.
-

Inserting batteries into remote controller

1. Firmly press the part on the cover and slide the cover in the direction indicated by the arrow.
2. Insert the batteries, making sure that the polarities are correct.
3. Close the cover.

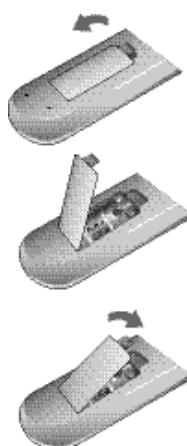

⚠ CAUTION : Risk of explosion if battery is replaced by an incorrect type.
Dispose of used batteries according to the national code (Recycling program).

How to use remote controller

- The remote controller should be operated within 30feet(7m) and 30° to the left and the right of the IR receiver on the front of the PDP.
- Used batteries should be disposed properly.



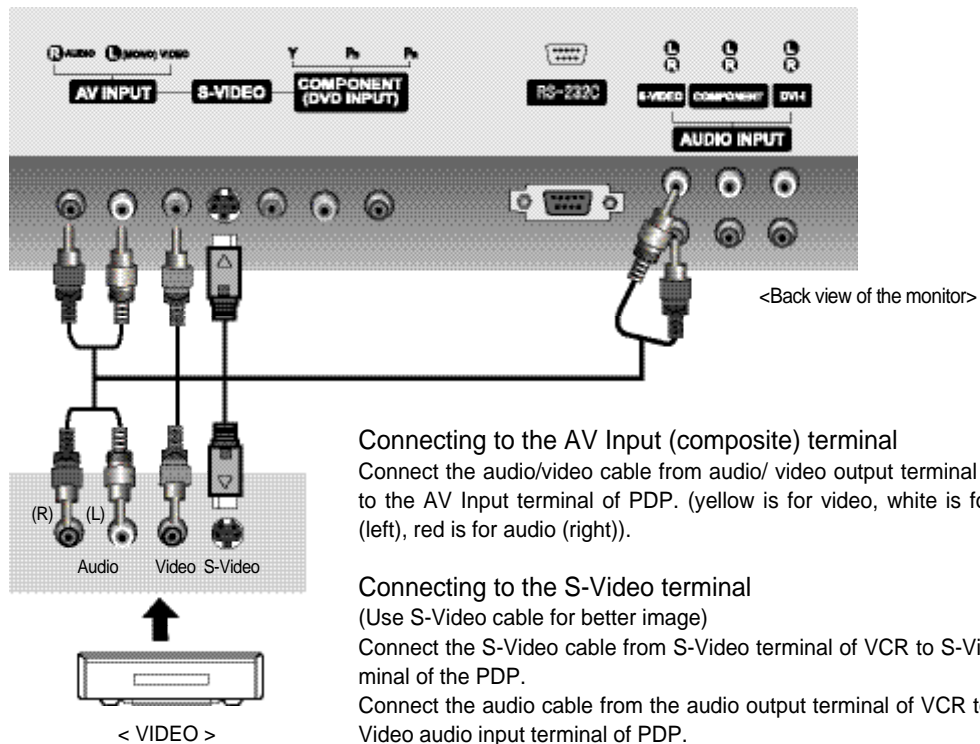

- Connecting to the VCR
- Connecting to the Cable TV

Connecting to the VCR



How to watch VCR on the PDP

1. Turn on the PDP monitor and press  on the remote controller.
2. Use  to select Composite or S-Video and then press .
3. Turn on the VCR, insert the tape and then press the Play button.

Connecting to the Cable TV

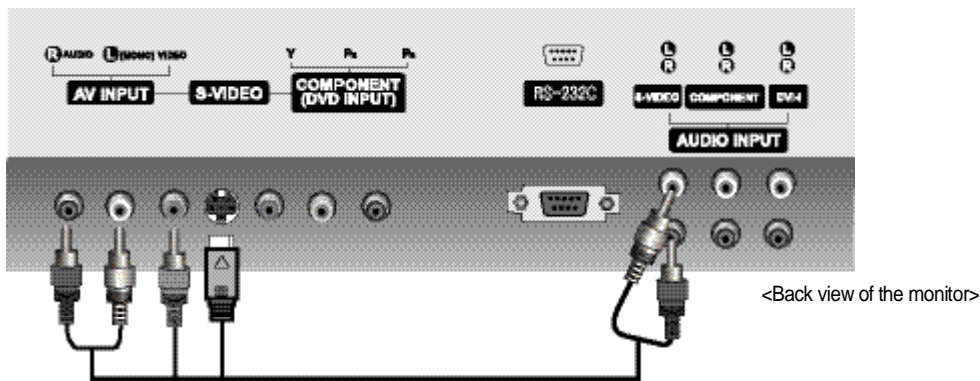

Connection

In order to watch cable TV, subscribe to your local cable TV company and install a separate converter (Set-Top-Box).

Connecting to the AV Input (composite) terminal

Connect the audio/ video cable from audio/ video output terminal of the Set-Top-Box to the AV Input terminal of PDP. (yellow is for video, white is for audio (left), red is for audio (right)).

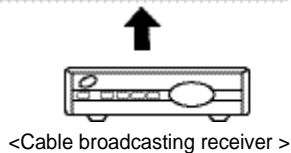
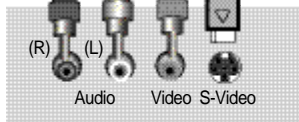



Connecting to the S-Video terminal

(Use S-Video cable for better image)

Connect the S-Video cable from S-Video terminal of Set-Top-Box to S-Video terminal of the PDP.

Connect the audio cable from the audio output terminal of Set-Top-Box to the S-Video audio input terminal of PDP.

How to watch a cable TV

1. Turn on the PDP monitor and press  on the remote controller.
2. Use  to select Composite or S-Video and then press .
3. Turn on Set-Top-Box and then select the channel you want.

- Connecting to the Camcorder/ Video game console
- Connecting to the DVD player

Connecting to the Camcorder/ Video game console

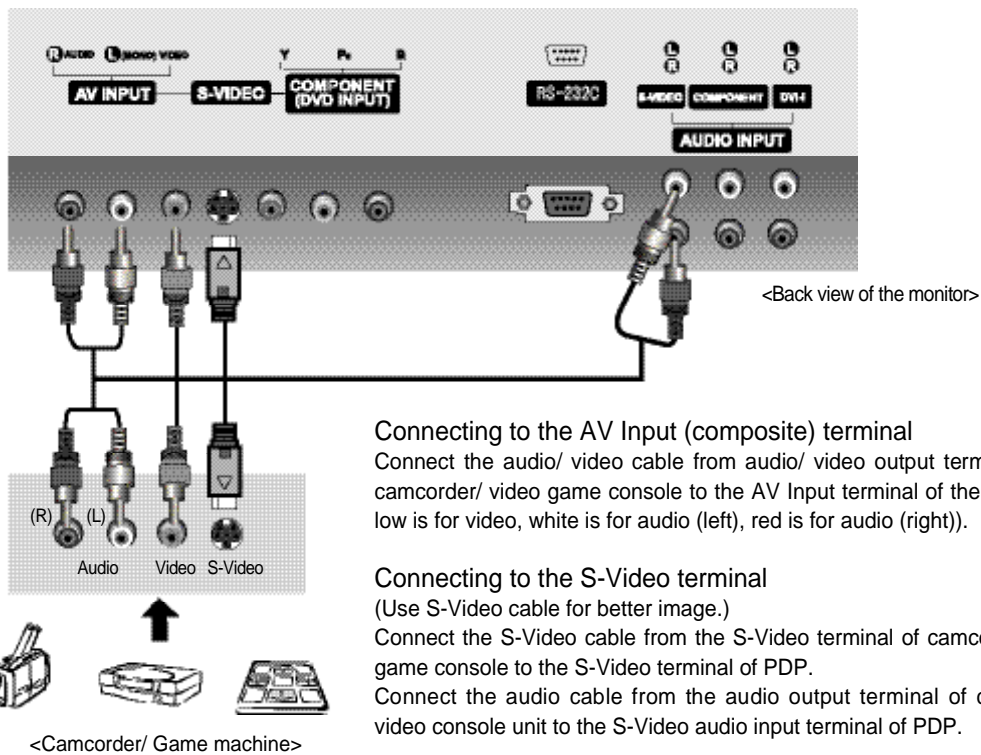

Connecting to the AV Input (composite) terminal

Connect the audio/ video cable from audio/ video output terminal of the camcorder/ video game console to the AV Input terminal of the PDP. (yellow is for video, white is for audio (left), red is for audio (right)).



Connecting to the S-Video terminal

(Use S-Video cable for better image.)

Connect the S-Video cable from the S-Video terminal of camcorder/video game console to the S-Video terminal of PDP.

Connect the audio cable from the audio output terminal of camcorder/ video console unit to the S-Video audio input terminal of PDP.

How to watch

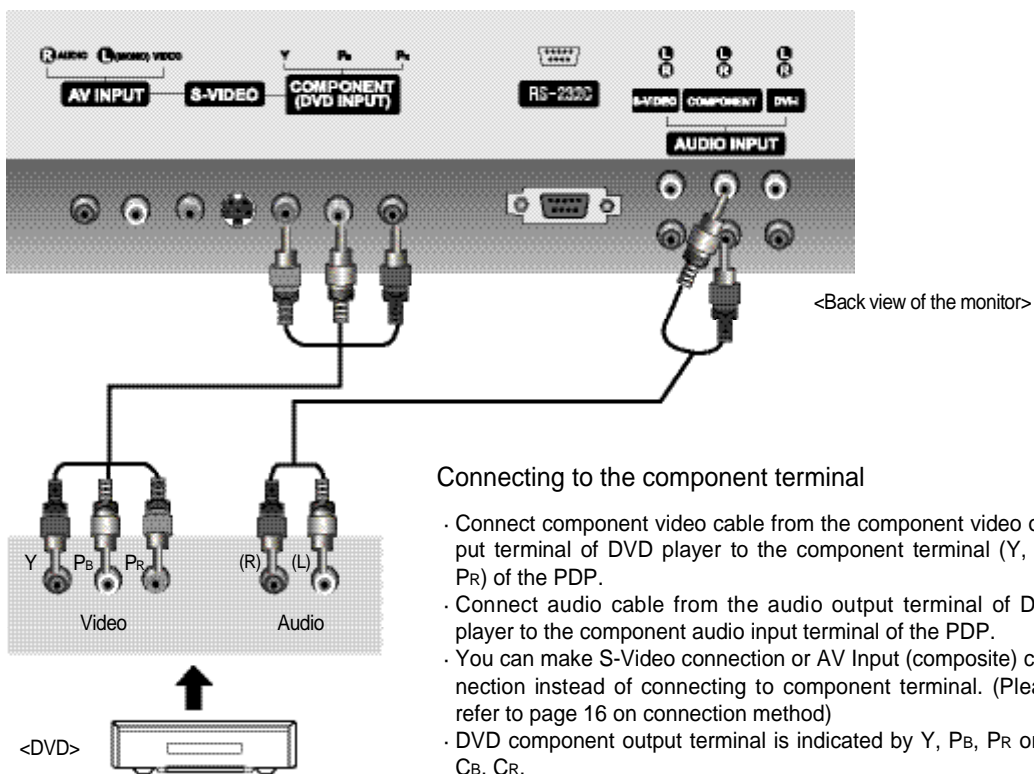

1. Turn on the PDP and press  on the remote controller.
2. Use  to select Composite or S-Video and then press .
3. Turn on the camcorder or video game and set to video mode.
(Please refer to the user's manual of camcorder/video game for more information.)
4. Insert tape into camcorder and press Play button or insert disc into the video game console.

Connecting to the DVD player



Connection

How to watch DVD

1. Turn on the PDP monitor and press  on the remote controller.
2. Use  to select component and then press .
3. Turn on DVD player and press Play button.

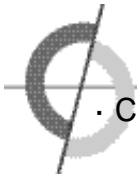

· Connecting to the DTV receiver

Connecting to the Component terminal/ Connecting to the DVI-I terminal

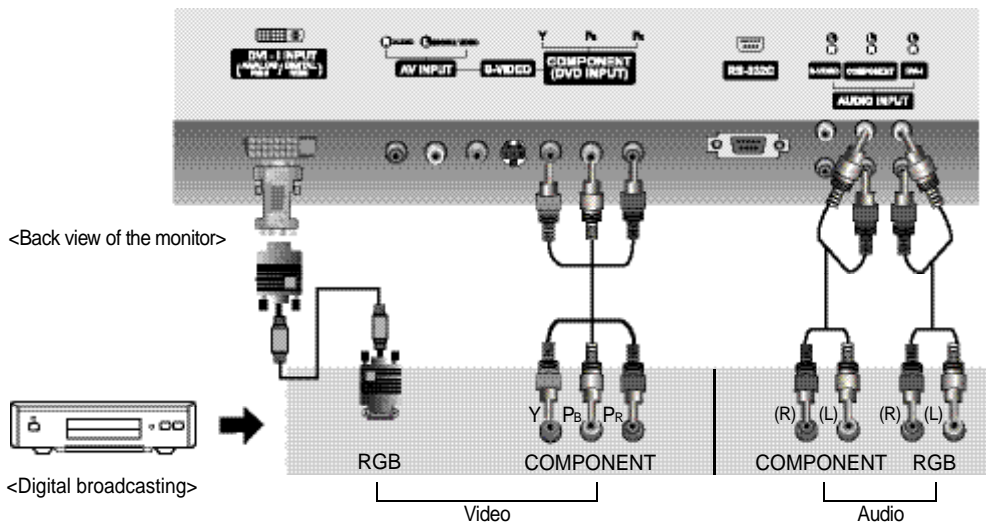

Connecting to the component terminal/ Connecting to the RGB terminal

- A separate Set-Top-Box may be required to receive digital broadcasting.
- In 1080i mode of DTV mode, the screen size selection is disabled, but fixed to 16:9 the screen size does not change.

Connecting to the component terminal

Connect component video cable from the component video output terminal of DTV receiver to the component terminal (Y, P_B, P_R) of the PDP.

Connect audio cable from the audio output terminal of DTV receiver to the component audio input terminal of the PDP.

- You can make S-Video connection or AV-Input connection instead of connecting to component terminal. (Please refer to page 16 on connection method)
- DTV component output terminal is indicated by Y, P_B, P_R or Y, C_B, C_R.







Connecting to the DVI-I terminal

Some of DTV receivers (Set-Top-Box) have an RGB connector (D-sub 15 pin) instead of a component output. The DVI adapter, which provides this connection terminal for the PDP, may be used for this connection.

Connect the DVI adapter into the VGA cable and connect to the PDP DVI-I input terminal. Connect the other end of the cable to D-sub output terminal of DTV receiver.

Connect audio cable from the audio output terminal of DTV receiver to the DVI-I audio input terminal of the PDP.

How to watch DTV

1. Turn on the PDP monitor and press  on the remote controller.
 2. Use  to select component and then press .
 3. When connecting DVI-I terminal, use  to select RGB1(Analog) and then press .
 4. Turn the DTV receiver on and select the channel that you want.
- DTV video output of 480p or 720p will show the clear and detail image of screen.

Connecting to the DVI-I terminal

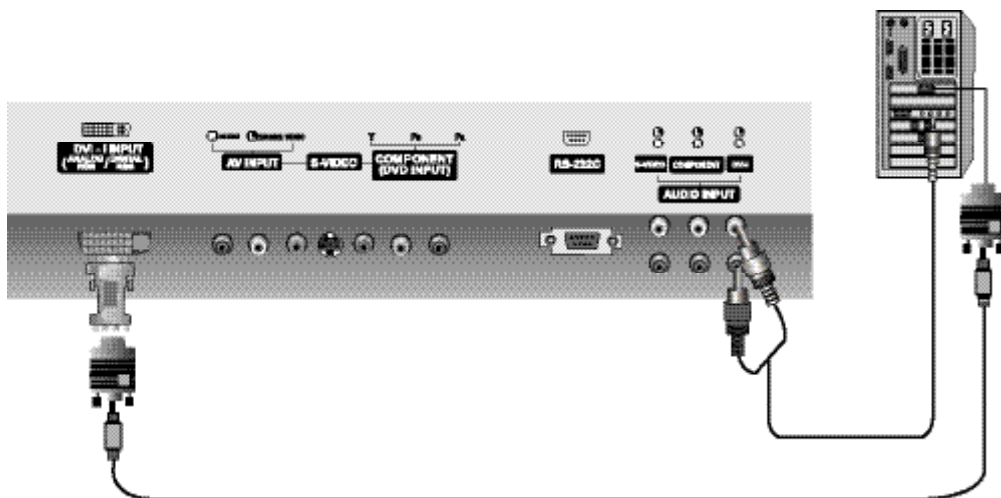

Connecting to the Analog RGB

Connecting to the Analog RGB terminal

Connect DVI adapter into VGA D-Sub cable, then connect to the PDP DVI-I input terminal. Connect the other end of the VGA Cable to D-sub Video output terminal of PC.

Connect audio cable from the audio output terminal of PC to DVI audio input terminal of the PDP. (PC audio cable is not included and should be purchased separately.)



PC audio works only if a Sound Card is installed.

Connecting to the Digital RGB

Connect DVI cable from the DVI output terminal of PC to the DVI-I input terminal of the PDP.

Connect audio cable from the audio output terminal of PC to the DVI audio input terminal of the PDP. (The DVI cable and the audio cable should be purchased. Contact your dealer.)

How to use as PC Monitor

1. Turn on the PDP and press  on the remote controller.
2. Use  to select RGB1(Analog) and then press .
(If the PC output is set to Digital, select RGB2(Digital).)
3. This PDP does not support Plug & Play function. When setting the PDP, select default.
4. Set the PC video output mode to VGA (640 × 480)/ SVGA (800 × 600)/ XGA (1024 × 768). In the mode higher than SXGA (1280 × 1024), "Out of Range" message appears. Be sure to change your PC video format to less than XGA mode. (Please refer to page 51 for the modes that PDP supports)

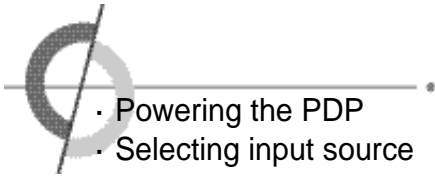

- Powering the PDP
- Selecting input source

Prior to using the PDP

Insert the power plug.

Connect external equipment properly.

- Please use only after carefully reading this manual.
- Check the power connection to the AC outlet and the connection of AC input to the PDP.



Power On/ Off

- To turn the PDP on :
Press the "Main Power" button of PDP and then press the "Standby" button.
- To turn the PDP off :
Press "Standby" button on the PDP and then press the "Main Power" button.
Turning the main power switch off will save energy. It is the same as unplugging the power cord.
If ON Time setting is set, the main power should be ON.
- To turn on/off by remote controller :
Press the POWER button of remote controller (If the PDP is not turned on, check that the "Main Power" button on the PDP main body is turned on. The main power indicator will light up red if turned on).

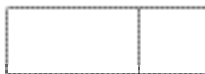
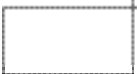
⚠ CAUTION - After turning off the main Power, please wait at least more than 3 seconds to turn the main power back on.



Selecting input source

Select the required input using  in the pop up menu by pressing  and then select with .

Press Composite button, S-VIDEO button, COMPONENT button, RGB1 button, and RGB2 button on the remote.



Ex) When selecting Analog RGB, press RGB1 button.



Basic Use

- 
-
- VOLUME - Adjusting the volume
 - MUTE - To mute the sound
 - STILL - To pause the screen
 - INFO - To check the current state
 - MENU - Checking the menu

VOLUME - Adjusting the volume

Press  for the volume increasing and press  or decreasing.

MUTE - To mute the sound

Press . If you press the button again, the sound turns back on.

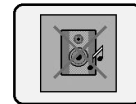

STILL - To pause the screen

Press . If you press the button again, the screen moves again.

INFO - To check the current state

Press . The current settings are displayed. It automatically disappears after three (3) seconds.

MENU - Checking the menu

If input selections are "AV Input (composite)", "S-video", and "Component", the video menu is activated.

If input selections are "RGB1" or "RGB2", the computer menu is activated.

The remote controller should be used for detailed menu settings and to change the settings.

Press  .

Use  to move the cursor bar up and down in the menu as shown in the figure.

Use  to move to sub menu and store the setting value.

Use  to leave the main menu.

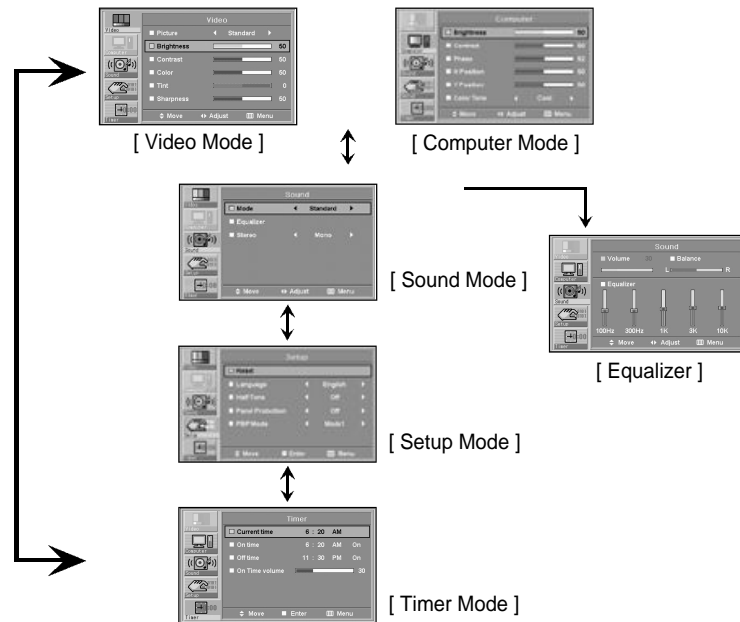



- PSM (Picture Status Memory)
- Adjusting the screen in USER mode

PSM (Picture Status Memory)

Press  .

Press  repeatedly to select the desired screen.

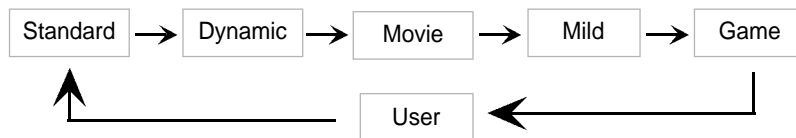

Press  .

1. Press  to move to  .

2. Press  to get into a sub menu.

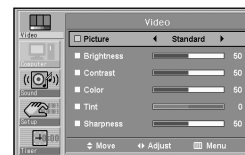

3. Select the required mode with  .

- Standard : It is the best screen setting (factory setting).
- Dynamic : Select when using the PDP in a brightly lit environment.
- Movie : Select when watching a movie. Then, *Film mode is operated.
- Mild : Select when using the PDP in a dimly lit environment.
- Game : Select to enjoy the Video games.
- User : Select to set user's preferences.

Film mode - It makes video that originated from film smoother, more continuous.

 **Warning** : Shadow image could remain on Dynamic mode due to image sticking phenomenon.

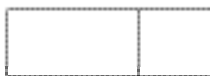
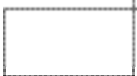

Adjusting the screen in USER mode

This is available when input signals are one of "AV input(composite)", "S-Video", and "Component".

- Adjustment is possible either in one of preset modes or in User mode.
- User defined values are stored in the User mode.

Press  .

1. Press  to move to  .

2. Press  to get into a sub menu.

3. Select the item to adjust with  .

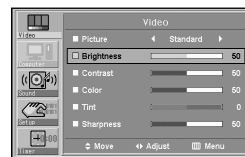

4. Adjust the setting value with  .



Press  after the adjustments are made.

To leave from the main menu, press  again.

Application

User Mode

- Brightness : It adjusts the brightness of the image.
 - Contrast : It adjusts the contrast of image.
 - Color : It adjusts the intensity of the color.
 - Tint : It adjusts the natural tint of the image.
 - Sharpness : It adjusts the clarity of the image.
-



- ARC (Aspect Ratio Control)
- Watching PIP

ARC (Aspect Ratio Control)

Press  .

Press  repeatedly to select the desired screen size.

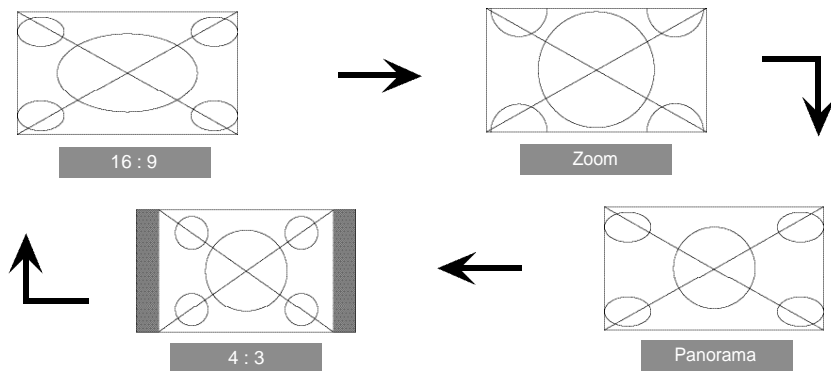
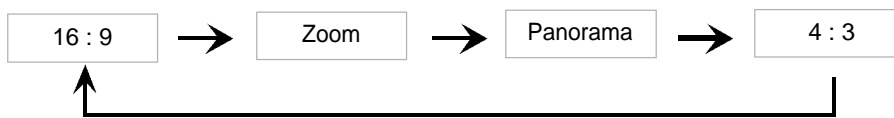

Screen Size

- 16 : 9 - It is a full screen size format.
 - Zoom - It enlarges the natural screen factor by approx. 5 %
 - Panorama - It makes 4:3 format fit into 16 : 9 format with minimal loss in content.
 - 4 : 3 - It is the standard format of broadcasting.
-

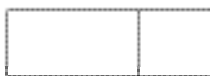
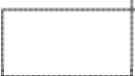

Watching PIP (Picture In Picture)

Press .

The followings will be displayed : Press  to activate PBP at once.

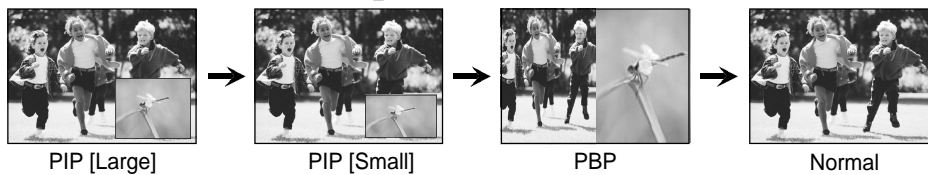

This function will work on Analog RGB, Digital RGB, Composite, S-video, and Component signals as inputs to main screen and Composite, S-Video and Component (480i) as inputs to sub-screen.
When watching PIP, the main screen and the sub-screen may have differences in the quality of screen color.
PBP only works in S-Video, Composite, Component (480i) input signals.

PIP Input(Changing the input signal of PIP)

Press  . The following sub-screen will be selected in order :
1. Composite / 2. S-Video / 3. Component.
Component input will display only 480i input.

PIP position (Moving the sub picture)

As you press , the location changes as illustrated next.

If the sub-screen does not appear, (only a black screen is shown)
check to see that input terminal is connected.

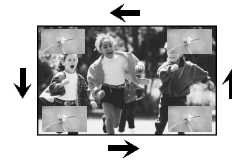

PIP Swap (How to exchange the main screen from sub screen)

Press , and the main/sub screen will be exchanged.
This does not work in Analog RGB, Digital RGB, and Component (480p, 720p, 1080i).



PIP Sound Swap (How to exchange the sound from the main to sub)

Press , the audio of the main/sub screen is exchanged.

PBP MODE (How to exchange the PBP mode)

Press , the mode of the PBP is exchanged from 16 : 9 to 4 : 3.

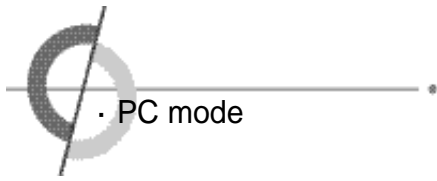



Adjusting the computer screen

This is an auto adjustment for Analog RGB only.

Auto adjustment

On Analog RGB use Auto adjustment, When the screen is not focused or centered.

1. Press  .
 2. You may have to press  multiple times to auto-adjust properly.
 3. If manual compensation is required, adjust it manually.
-

Auto Adjustment works only on Analog RGB signals.

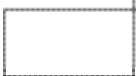



Manual adjustment

Use this if fine adjustment is required after auto adjustment.

Press  .

1. Press  to move to  .

2. Press  to get into the sub menu.

3. Select the item to adjust with  .



4. Adjust the setting value with  .



Press  after making adjustments to return to the previous menu.

Press it again to leave the menu.

User Mode

- Brightness : It adjusts the brightness of the image.
- Contrast : It adjusts the contrast of the image.
- Phase : It adjusts the phase shift of the image. Use when image appears blurry or out of focus.
- H-Position : It moves the image on the screen horizontally.
- V-Position : It moves the image on the screen vertically.

Phase, H-Position, V-Position are not adjustable in Digital RGB(RGB2).





- Color Tone (Pre-set)
- Color Tone (Manual adjustment)

Color Tone (Pre-set)

Press  .

1. Press  to move to  .

2. Press  to get into a sub menu.

3. Select the item "Color Tone" with  .

4. Select the required color among "Cool", "Normal", "Warm", and "User" with  .

Press  after making adjustments to return to the previous menu.
Press it again to leave the menu.

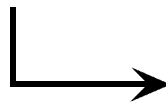

User Mode

- Cool : This results in a blueish tone.
- Normal : This is standard color setting.
- Warm : This results in a reddish tone.
- User : The user adjustable color of basic color segment of red, green and blue.

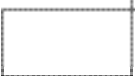



Color Tone (Manual adjustment)

Press  .

1. Press  to move to  .

2. Press  to get into a sub menu.

3. Select the item "Color Tone" with  .

4. Select "User" with  .

5. Press  .

6. Select the item to adjust with  .

7. Adjust the setting value with  .

Press  after making adjustments to return to the previous menu.

Press it again to leave the menu.

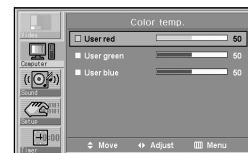

Application



- SSM (Sound Status Memory)
- Equalizer

SSM (Sound Status Memory)



Listening to the selected sound:

Press  .

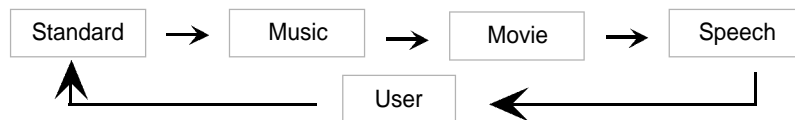
Select the pre-set sound mode by pressing the SSM button.



Press  .

1. Press  to move to  .

2. Press  to get into sub menu.

3. Select one of the pre-set modes with  .

Press  after the selection to return to the previous menu.

Press it again to leave the menu.

Modes

- Standard : It is the flat sound setting with no equalizer effect at all.
- Music : It is preset for music listening.
- Movie : It is preset sound for watching a movie.
- Speech : It is preset for hearing vocal audio clearly.
- User : Select when listening to the sound to user's preference.
(Please refer to page 37 Equalizer.)

Equalizer

Adjustment is possible in any equalizer mode and will be stored in the user mode.

Press  .

1. Press  to move to .

2. Press  to get into the sub menu.

3. Select equalizer with .

4. Press , then the equalizer menu pop up.

5. Select the menu with  and adjust

the setting value with .

Press  after making adjustments to return to the previous menu.

Press again to leave the menu.

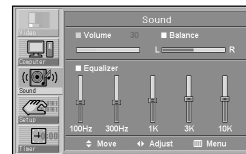
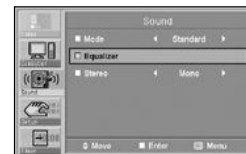

Application

User Mode

- Volume : It adjusts the sound volume.
- Balance : It adjusts the volume of speakers on the left and the right.
- Equalizer : It adjusts the volume by frequency bands and the user can select the desired sound quality.





- Stereo
- Reset

Stereo (How to set stereo)

If TV signal reception is poor, the separation of stereo will be bad and noisy. In this occasion, set the stereo to mono.

Press  .

1. Press  to move to  .

2. Press  to get into the sub menu.

3. Select "Stereo" with  .

4. Select "Stereo" with  .



Press  after making adjustments to return to the previous menu.

Press it again to leave the menu.

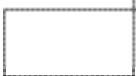

Reset (Factory default)

It resets all of the parameters to the factory default.

Press  .

1. Press  to move to  .

2. Press  to get into the sub menu.



3. Reset by pressing  .

Press  after making adjustments to return to the previous menu.

The PDP will turn off then turn back on in few seconds. The parameters will be set to factory default.

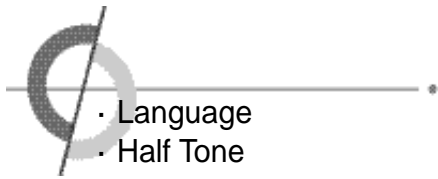



Language

It adjusts the language of the OSD(On Screen Display) menu.

Press .

1. Press  to move to .

2. Press  to get into the sub menu.

3. Select the "Language" with .

4. Select the desired language with .



Press  after making adjustments to return to the previous menu.

Press it again to leave the menu.

Half Tone

It changes the background color of the menu frame.
It can be set in a semitransparent or opaque manner.

Press  .

1. Press  to move to  .

2. Press  to get into the sub menu.

3. Select "Half Tone" menu with  .



4. Select "On (Semitransparent)" or "Off (Opaque)" by pressing  .

Press  after making adjustments to return to the previous menu.

Press it again to leave the menu.



Application

Panel Protection (How to set the panel protection function)



It is recommended that the panel protection mode be used on a paused/ frozen screen or on a screen on which a company's logo remains for a long period.

There is a possibility that screen flickers during changing panel protection mode. But, it is not a defect.

Press  .

1. Press  to move to  .

2. Press  to get into the sub menu.

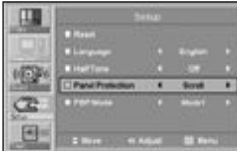
3. Select the required panel protection mode with  .  

Press  after making adjustments to return to the previous menu.

Press it again to leave the menu.

-
- Scroll : This is a function that scrolls a screen at 10 second intervals.
 - Bright Down : This is a function that lowers brightness of the screen for panel protection.
 - All : Scroll and Bright Down mode are simultaneously operated.
 - Off : Panel Protection mode is not operated.

⚠ CAUTION - This function does not fully prevent the image sticking that occurs when the fixed screen continues for long, due to the feature of the panel.(Please refer to page 5)

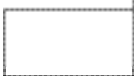



PBP Mode

- It changes the ratio of the PBP screen from 16:9 to 4:3.

Press  .

1. Press  to move to  .

2. Press  to get into the sub menu.

3. Select "PBP Mode" menu with  .

4. Select "Mode 1" or "Mode 2" by pressing  .

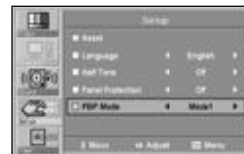

Press  after making adjustments to return to the previous menu.

Press it again to leave the menu.

PBP Modes

- Mode 1 : It makes 16:9 PBP ratio.
 - Mode 2 : It makes 4:3 PBP ratio.
-



- Current Time setting
- On Time / Off Time (Time setting)

Current Time (How to set the current time)

It sets the current time and then the automatic turn on/off can be set.



The time settings are retained only if the main power is on. If the Main power is off, the time is reset. To retain the time setting, do not turn the main power switch off.



Press  .

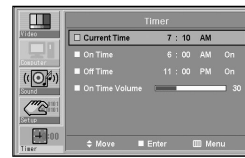

1. Press  to move to  .

2. Press  to get into the sub menu.



Move to "Hour" with  and adjust "Current Hour" with  .

Move to "Minute" with  and then adjust "Current Minute" with  .

Move to "AM" with  and then select "AM" or "PM" with  .

Press  after adjustment to return to the previous menu.

Press it again to leave the menu.

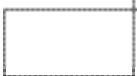

Once "Current Time" is set, "On Time", "Off Time", "On time volume" settings are adjustable.





On Time / Off Time (Time setting)

Current Time must be set correctly for this function to work.



Press  .



1. Press  to move to  .

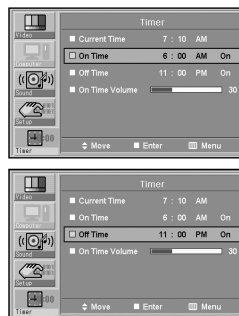

2. Press  to get into the sub menu.



3. Select "On Time" or "Off Time" with  .



Move to "Hour" with  and then adjust the desired "Hour" with  .

Move to "Minute" with  and then adjust the desired "Minute" with  .

Move to "AM" with  and then select "AM" or "PM" with  .

Move to "Off" with  and then select "On" with  .

Press  after making adjustments to return to the previous menu.

Press it again to leave the menu.

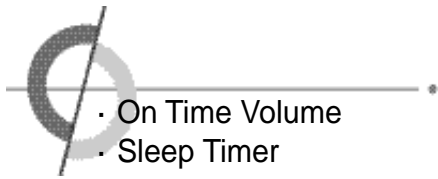



On Time Volume (How to set the volume)

Current time must be set correctly for this function to work.

Press  .

1. Press  to move to  .

2. Press  to get into the sub menu.

3. Select "On Time Volume" with  .

4. Adjust the desired volume value with  .

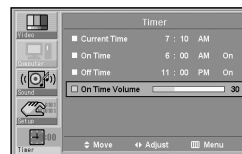

Press  after making adjustments to return to the previous menu.

Press it again to leave the menu.

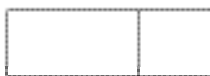



Sleep Timer

It sets time to make automatic turn off for the sleeping.

Press  .

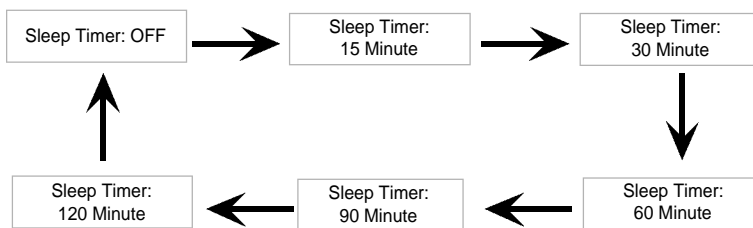
The selection of the sleep timer will appear.



To disable the sleep timer set it to "Sleep Timer: OFF" by pressing  .

Sleep timer : OFF

After the sleep timer appears on the screen for more than 20 seconds without pressing the "Sleep" button, the appeared sleep timer is automatically set.

To check the current "Sleep timer" setting, press  once.

Reset the sleep timer again, after the PDP power is turned off.

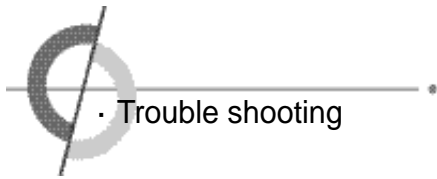

Trouble shooting

In case a problem occurs with your PDP TV, please take the following steps first.
If you still have the problem, turn the power off and contact your dealer or an authorized service center.

• Screen related Matters

Problem	Action
The screen does not appear.	Is the power plug pulled out? Insert the power plug. Turn the main power button on and press the power button of the remote controller.
The screen appears too slowly after the power is turned on.	This problem occurs for a brief time in the process of image elimination processing in order to hide temporary screen noise that occurs when the power is turned on. But if the screen does not come after 1 minute has passed, contact your dealer or an authorized service center.
Screen is too bright or too dark.	Perform brightness adjustment or Contrast adjustment. (Please refer to page 37)
Screen is too large or too small.	Adjust the screen size. (Please refer to page 38)
Stripes appear on the screen and it shakes.	Stop using wireless telephones, hair driers and electric drills.
Screen appears in black and white.	Adjust the screen in user mode. (Please refer to page 37)
Simultaneous Screen does not appear.	Check that PDP TV and external equipment are connected. Check the inputs of simultaneous screen by pressing sub-screen selection.
The screen does not move.	Press the STILL button. (Please refer to page 28) Check if the Pause button is pressed on external equipment.
Computer Input Screen is abnormal.	Execute automatic adjustment by pressing AUTO ADJ button. If the screen is still abnormal after automatic adjustment, perform manual fine adjustment. Please refer to page 41.
Automatic Turn On does not work.	Automatic Turn On function works only when turning the PDP TV off with the remote controller or Standby button.

• Sound related Matters

Problem	Action
Screen appears, but there is no sound.	<ol style="list-style-type: none"> 1. Press the "Mute" button. (page 26) 2. Increase the sound by pressing volume adjustment button. 3. Check if voice terminal of external input is connected properly. 4. Check if speaker cables are connected properly. 5. If it is on PIP mode, convert audio of main screen and sub-screen by pressing S/SWAP. 6. Select and check the other input. If the sound still does not work and the other channels are the same after you have done as the above, contact your dealer or an authorized service center.
Lots of noise (static) occurs.	When connecting a Set-Top-Box, check that it is on stereo broadcasting. If it is, the TV channel may not be available or the reception may be bad. Select "Mono" (Please refer to page 38) Check the audio source with another player. If that source is good, contact your dealer or an Authorized service center.

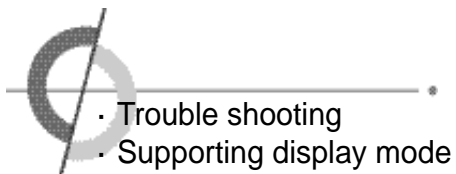

• Others

Problem	Action
remote controller does not work.	1. Check if main power is On. 2. Check that the batteries of the remote controller were loaded properly. 3. Check to see if any obstacle exists between the PDP TV and the remote controller and remove it, if any. 4. If the batteries have no power, replace them with two new batteries.
PDP TV makes strange noise.	It is the noise when the mechanism expands or contracts from to changes to the environment due to factors such as humidity, temperature, etc. It is not a failure.
PDP TV indication lamp is On.	The red means the Stand-by power is ON. It will take a few seconds to turn off as the main power is off.

This PDP TV is for household use and registered as suitable on electromagnetic waves. Therefore, you can use it in every location as well as residential areas.

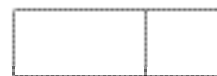

Supporting display mode

It is optimal screen when the resolution is 640 x 480.

Resolution	Horizontal Frequency (KHz)	Vertical Frequency (Hz)
640 x 480	31.47	60
	37.86	72
	37.50	75
720 x 400	31.47	70
800 x 600	35.15	56
	37.88	60
	48.88	72
	46.88	75
1024 x 768	48.36	60
	56.48	70
	60.02	75

Considerations in Installation

If any signal of unsupported resolution is input, the "Out of Range" message appears.



· MEMO
· Specifications

Component Mode [Y, C_B(P_B), C_R(P_R)]

Resolution	Horizontal Frequency (KHz)	Vertical Frequency (Hz)	
720 x 480	15.73	60.00	SDTV, DVD 480i
720 x 480	15.63	50.00	SDTV, DVD 576i
720 x 480	31.47	59.94	SDTV, 480p
1280 x 720	45.00	60.00	HDTV, 720p
1280 x 720	44.96	59.94	HDTV, 720p
1920 x 1080	33.75	60.00	HDTV, 1080i
1920 x 1080	33.72	59.94	HDTV, 1080i

Specifications

Aspect Ratio	16 : 9
Screen Size (H x V)	920.1 x 518.4mm
Resolution	852 x 480(Wide VGA)
Cell pitch (H x V)	0.36(H) x 1.08(V)mm
Displayable Colors	16.77M(256 x 256 x 256)
Brightness	1000cd/m ² (w/o filter)
Contrast	1200:1
Color Temperature	9500 °K
Viewing Angle	160 °
Input signal	NTSC, PAL-M, PAL-N, PAL, SECAM, SD, HD, VGA, SVGA, XGA
RGB Input	DVI - (Analog/Digital RGB)
AC Input	AC100-240V~, 50/60Hz, 4A
Power Consumption	320W

If any signal of unsupported resolution is input, the "Out of Range" message appears.

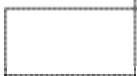

MEMO



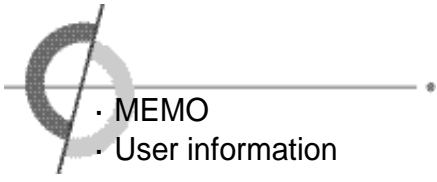

MEMO

User information

Note: This equipment has been tested and found to comply with the limit for a Class B digital device, pursuant to part 15 of the FCC Rules. These limits are designed to provide reasonable protection against harmful interference when the equipment is operated in a commercial environment.

This equipment generates, uses and can radiate radio frequency energy and, if not installed and used in accordance with the instruction manual, may cause harmful interference to radio communications.

Operation of this equipment in a residential area is likely to cause harmful interference in which case the user will be required to connect the interference at his own expense.

Change or modification not expressly approved by the party responsible for compliance could void the user's authority to operate the equipment.

This is a class B product. In a domestic environment this product may cause radio interference in which case the user may be required to take adequate measures.