

# EP4650/EP5550 User Guide



Arrivals				
Time	Airline	Flight	From	Terminal
7:25	QANTAS AIRWAYS	QF3950	Mumbai	1
7:25	JET AIRWAYS	9W12	Mumbai	2
7:30	SILKAIR (SINGAPORE) PTE LTD	MI457	Coimbatore	3
7:30	SINGAPORE AIRLINES LTD	SQ5357	Coimbatore	4
7:30	SINGAPORE AIRLINES LTD	SQ469	Colombo	9
7:35	ALL NIPPON AIRWAYS (NH)	NH6279	New Delhi	5
7:35	SINGAPORE AIRLINES LTD	SQ407	New Delhi	6
7:35	SINGAPORE AIRLINES LTD	SQ5377	Hyderabad	1
7:35	SILKAIR (SINGAPORE) PTE LTD	MI477	Hyderabad	7
7:35	VIRGIN ATLANTIC AIRWAYS	VS7327	Manchester	8
7:40	VIRGIN ATLANTIC AIRWAYS	SQ327	Manchester	9
7:40	SINGAPORE AIRLINES LTD	US5412	Manchester	1
7:40	US AIRWAYS	3K564	Manila	2
7:40	JETSTAR	VS7317	London-Heath	3
7:40	VIRGIN ATLANTIC AIRWAYS	SQ317	London-Heath	4
7:45	SINGAPORE AIRLINES LTD	AC6299	London-Heath	5
7:45	AIR CANADA	AI442	Mumbai	6
7:50	AIR INDIA			

Copyright © 9 May 2013 by Planar Systems, Inc. All rights reserved.

Contents of this publication may not be reproduced in any form without permission of Planar Systems, Inc.

### Trademark Credits

Windows™ is a trademark of Microsoft Corp.

All other companies are trademarks or registered trademarks of their respective companies.

### Disclaimer

The information contained in this document is subject to change without notice. Planar Systems, Inc. makes no warranty of any kind with regard to this material. While every precaution has been taken in the preparation of this manual, the Company shall not be liable for errors or omissions contained herein or for incidental or consequential damages in connection with the furnishing, performance, or use of this material.

### Warranty and Service Plans

Planar warranty and service plans will help you maximize your investment by providing great support, display uptime, and performance optimization. From post-sale technical support to a full suite of depot services, our services are performed by trained Planar employees. When you purchase a Planar product, you get more than a display, you get the service and support you need to maximize your investment. To find the latest warranty and service information regarding your Planar product, please visit <http://www.planarcontrolroom.com/support>

### RoHS Compliance Statement

The EP4650/EP5550s are fully RoHS compliant.

Part Number: 020-1228-01A

# Table of Contents

- EP4650/EP5550 User Guide** ..... i
  
- Introduction** .....1
  - Safety Information .....2
  - Safety Precautions.....2
  - Recommended Usage .....4
  - VESA Mounts, General Description .....6
  - Cleaning the EP4650/EP5550 .....7
  
- Package Contents**.....8
  - Unpacking the EP4650/EP5550 .....8
  
- Dimensions** ..... 11
  - EP4560 - Front ..... 11
  - EP4560 - Rear ..... 12
  - EP4560 - Side..... 13
  - Standard Inputs ..... 13
  - Optional HD-SDI/VW Inputs ..... 14
  - EP5550 - Front ..... 14
  - EP5550 - Rear ..... 15
  - EP5550 - Side..... 16
  
- Installing an EP4650/EP5550** ..... 17
  - Before You Begin..... 17
  - Power Input..... 18
  
- Operating the EP4560/EP5550**..... 19

OSD Keypad .....	19
Remote Control Receiver .....	20
LED Indicators .....	21
Using the Display in Portrait Mode.....	21
Using the Remote Control .....	22
Turning the EP4650/EP5550 On.....	25
Turning the EP4650/EP5550 Off .....	26
Adjusting the Volume .....	26
Selecting the Input Source .....	27
PIP Mode .....	28
OSD Menu Functions.....	31
OSD Menus .....	36
Navigating Through the Menus.....	40
Default Settings.....	58
<b>LAN Control.....</b>	<b>59</b>
Supported Operating Systems.....	59
Installation.....	59
Configuring VCOM .....	63
Function Descriptions .....	65
<b>Setting Up Email Alerts .....</b>	<b>69</b>
Login .....	69
Administrator .....	71
TCP Mode, UDP Mode and UART.....	74
SMTP .....	74
Reset Device .....	75
<b>Signal Compatibility .....</b>	<b>76</b>

---

<b>Specifications</b> .....	78
<b>Troubleshooting</b> .....	80
<b>Accessing Planar's Technical Support Website</b> .....	81
Downloading Additional Documentation and Firmware .....	81
Downloading Utility Software .....	82



# Introduction

The EP4650/EP5550 is a 46" or 55" diagonal edge-lit LED LCD display that can be wall mounted, ceiling mounted or mounted on a stand. The display can be portrait or landscape.

The EP4650 and EP5550 are ultra slim and have an aspect ratio of 1.77 (16:9). The EP4650/EP5550 have a native HD (1920 x 1080) resolution and both accept a wide range of input pictures from VGA to 1080p.

Additional features of the Planar EP4650 and EP5550 include ambient light control, a wide range of source connectivity, and display control through LAN or RS232. The EP series displays also provide superior energy efficiency in a lightweight design.

**Caution:** This manual is intended for use by qualified service persons and end users with experience installing LCD displays.

## Safety Information

Before using the EP4650/EP5550, please read this manual thoroughly to help protect against damage to property, and to ensure personnel safety.

- Be sure to observe the following instructions.
- For your safety, be sure to observe ALL the warnings detailed in this manual.
- For installation or adjustment, please follow this manual's instructions, and refer all servicing to qualified service personnel.

## Safety Precautions

- **If water is spilled or objects are dropped inside the ep46L/ep55L, remove the power plug from the outlet immediately.** Failure to do so may result in fire or electrical shock. Contact your dealer for inspection.
- **If the EP4650/EP5550 is dropped or the chassis is damaged, remove the power plug from the outlet immediately.** Failure to do so may result in fire or electrical shock. Contact your dealer for inspection.

**WARNING!** Wall mounts must be secure.

- **If the display is hung on a wall, the wall must be strong enough to hold it.** Simply mounting it to wallboard or wall paneling won't be adequate or safe.

**Caution:** The screen could be damaged by heavy pressure.

- **Slight pressure on the LCD will cause distortion of the image.** Heavier pressure will cause permanent damage. Displays should be mounted where viewers cannot touch the screen or insert small objects in the openings that will create hazards by contacting bare conductive parts.

**Caution:** The front polarizer is soft and subject to scratches from sharp objects.

- **The polarizer is a thin sheet of film laminated to the outside layer of glass on the LCD screen.** Take care when handling items near the screen.
- **If the power cord or plug is damaged or becomes hot, turn off the main power switch of the display. Make sure the power plug has cooled down and remove the power plug from the outlet.** If the EP4650/EP5550 is still used in this condition, it may cause a fire or an electrical shock. Contact your dealer for a replacement.



## Important Safety Instructions

- 1** Read these instructions.
- 2** Keep these instructions.
- 3** Heed all warnings.
- 4** Follow all instructions.
- 5** Do not use the EP4650/EP5550 near water.
- 6** Clean the LCD screens with an LCD screen cleaner or LCD wipes.
- 7** Do not install near any heat sources such as radiators, heat registers, stoves or other apparatus (including amplifiers) that produce heat.
- 8** Do not defeat the safety purpose of the polarized or grounding type plug. A polarized plug has two blades with one wider than the other. A grounding type plug has two blades and a third grounding prong. The wide blade or the third prong is provided for your safety. When the provided plug does not fit into your outlet, consult an electrician for the replacement of the obsolete outlet.
- 9** Protect the power cord from being walked on or pinched, particularly at plugs, convenience receptacles and the point where they exit from any of the EP4650/EP5550 displays.
- 10** Only use the attachments/accessories specified by the manufacturer.
- 11** Unplug all displays during lightning storms or when unused for long periods of time.
- 12** You must follow all National Electrical Code regulations. In addition, be aware of local codes and ordinances when installing your system.
- 13** Refer all servicing to qualified service personnel. Servicing is required when any of the displays have been damaged in any way. For example, if the AC power cord or plug is damaged, liquid has been spilled or objects have fallen into a display, the displays have been exposed to rain or moisture, do not operate normally or have been dropped.
- 14** Keep the packing material in case the equipment should ever need to be shipped.
- 15** Wall mounts must be secure. The wall must be strong enough to hold all EP4650/EP5550s, brackets and cables.

- 16 Slight pressure on the LCD will cause distortion of the image. Heavier pressure will cause permanent damage. Displays should be mounted where viewers cannot touch the screen or insert small objects in the openings that will create hazards by contacting bare conductive parts.
- 17 The front polarizer is soft and subject to scratches from sharp objects. The polarizer is a thin sheet of film laminated to the outside layer of glass on the LCD screen. Take care when handling items near the screen.

## Recommended Usage

In order to get the most out of your LCD, use the following recommended guidelines to optimize the display.

### Burn-In Versus Temporary Image Retention

Burn-in causes the screen to retain an image essentially forever, with little or no way to correct the problem. Under normal use, an LCD will not experience burn-in, as plasma displays do, nor will it retain images in any way.

Normal use of an LCD is defined as displaying continuously changing video patterns or images. However, LCDs can experience *temporary* image retention when recommended usage guidelines are not followed.

#### What is Temporary Image Retention?

Temporary image retention (TIR) can occur when a static image is displayed continuously for extended periods of time (12 hours or longer). An electrical charge differential may build up between the electrodes of the liquid crystal, which causes a negative-color video image (color-inverted and brightness-inverted version of the previous image) to be retained when a new image is displayed. This behavior is true for any LCD device from any LCD manufacturer.

TIR is not covered under warranty. See standard warranty terms and conditions for details. Here are some guidelines to help you avoid TIR:

- Use the LCD to show a screen saver, moving images or still pictures that change regularly. When using high-contrast images, reposition the images frequently.
- Turn off the LCD when it is not in use. To use your source computer's Power Options Properties, set up your computer to turn off the display when not in use.

**Caution:** For optimal performance, we suggest turning off the backlight power on the EP4650/EP5550 for six hours per day.

## European Union Disposal Information

English

- Disposal of old Electrical & Electronic Equipment (Applicable throughout the European Union and other European countries with separate collection programs)

This symbol found on your product or on its packaging, indicates that this product should not be treated as household waste when you wish to dispose of it. Instead, it should be handed over to an applicable collection point for the recycling of electrical and electronic equipment. By ensuring this product is disposed of correctly, you will help prevent potential negative consequences to the environment and human health, which could otherwise be caused by inappropriate disposal of this product. The recycling of materials will help to conserve natural resources.



This symbol is only valid in the European Union. If you wish to discard this product, please contact your local authorities or dealer and ask for the correct method of disposal.

Español

- Deshecho de equipos eléctricos y electrónicos (aplicable a la Unión Europea y a otros países europeos con programas de reciclaje independientes)

La presencia de este símbolo en el propio producto o en su material de embalaje, indica que no se debe tratar como residuo doméstico cuando desee deshacerse de él. En su lugar, debe entregarlo en el punto limpio correspondiente de reciclaje de equipos eléctricos y electrónicos. Asegurándose de que este producto se desecha de forma correcta, ayudará a evitar posibles consecuencias negativas para la conservación del medioambiente y la salud humana, consecuencias que podrían darse si se desecha del producto de forma inadecuada. El reciclado de materiales ayuda a conservar los recursos naturales.



Este símbolo solamente es válido en la Unión Europea. Si desea deshacerse de este producto, póngase en contacto con las autoridades locales o con su distribuidor y pida información sobre el método de disposición adecuado.

Português

- Eliminação de equipamentos eléctricos e electrónicos usados (aplicável na União Europeia e noutros países europeus com programas próprios de recolha destes equipamentos)

Este símbolo, colocado no produto ou na respectiva embalagem, indica que o produto não deve ser tratado como lixo doméstico aquando da sua eliminação. Em vez disso, deve ser entregue num ponto de recolha de equipamentos eléctricos e electrónicos para posterior reciclagem. Ao garantir a correcta eliminação deste produto, estará a evitar consequências potencialmente negativas tanto para o ambiente como para a saúde humana. A reciclagem de materiais ajuda a preservar os recursos naturais.



Este símbolo apenas é válido na União Europeia. Se quiser eliminar este produto, contacte as entidades locais ou o seu fornecedor para ficar a saber qual o método de eliminação correcto.

Svenska

- Avfall av förbrukad elektrisk och elektronisk utrustning (Tillämpbart i hela Europeiska unionen och andra europeiska länder med separata samlingsprogram)

Den här symbolen som finns på din produkt eller på dess förpackning påvisar att produkten inte ska behandlas som hushållsavfall när du vill slänga bort den. Istället ska den lämnas över till en lämplig uppsamlingspunkt för återvinning av elektriska och elektroniska utrustningar. Genom att tillförsäkra att den här produkten återvinns på ett riktigt sätt hjälper du till med att förhindra möjliga negativa konsekvenser för miljön och mänsklig hälsa. Det kan annars orsakas på grund av olämplig sophantering av den här produkten. Återvinning av material kommer att hjälpa till att bevara naturtillgångar.



Den här symbolen är endast giltig inom den Europeiska unionen. Om du vill slänga bort den här produkten ska du kontakta lokala myndigheter eller återförsäljare, och fråga efter lämplig avfallsmetod.

Français

- Mise au rebut des équipements électriques et électroniques usagés (Valable dans l'ensemble de l'Union Européenne ainsi que dans les pays européens disposant de programmes distincts de collecte des déchets)

Ce symbole appliqué sur votre produit ou sur son emballage indique que ce produit ne doit pas être traité comme un déchet ménager lorsque vous voulez le mettre au rebut. Il doit au contraire être remis à un site de collecte agréé pour le recyclage des équipements électriques et électroniques. En veillant à ce que ce produit soit mis au rebut de façon adéquate, vous contribuerez à prévenir les conséquences potentiellement négatives sur l'environnement et sur la santé humaine qui risqueraient de se produire en cas de mise au rebut inappropriée de ce produit. Le recyclage des matériaux contribuera également à économiser les ressources naturelles.



Ce symbole n'est valable que dans l'Union Européenne. Si vous souhaitez mettre ce produit au rebut, veuillez prendre contact avec les autorités locales ou avec votre revendeur et renseignez-vous sur la méthode de mise au rebut correcte.

Italiano

- Smaltimento delle attrezzature elettriche ed elettroniche usate (applicabile in tutta la Comunità Europea ed altri Paesi Europei che applicano programmi di raccolta differenziata)

Il simbolo trovato sul prodotto, o sulla sua confezione, indica che il prodotto non può essere trattato come i domestici quando è il momento di smaltirlo. Al contrario, deve essere consegnato ad un centro di raccolta specializzato nel riciclaggio di attrezzature elettriche ed elettroniche. Assicurando che il corretto smaltimento di questo prodotto, si aiuterà a prevenire potenziali conseguenze negative sull'ambiente e sulla salute umana, che possono essere provocate da uno scorretto smaltimento di questa attrezzatura. I materiali riciclati aiuteranno a conservare le risorse naturali.



Questo simbolo è valido solo nell'Unione Europea. Per smaltire questo prodotto, mettersi in contatto con le autorità locali - o con il rivenditore - e chiedere informazioni sul corretto metodo di smaltimento.

Polski

- Usowanie zużytego sprzętu elektrycznego i elektronicznego (Dotyczy krajów Unii Europejskiej i innych krajów europejskich z oddzielnymi programami zbiórki odpadów)

Obecność tego symbolu na produkcie lub na opakowaniu z produktem oznacza, że tego produktu nie można wyrzucić razem z odpadkami domowymi. Należy go przekażać do punktu zbiórki w celu poddania recyklingowi podzespołów elektrycznych i elektronicznych. Usunięcie tego produktu w prawidłowy sposób, pomoże w zabezpieczeniu przed negatywnym wpływem odpadów na środowisko i zdrowie ludzi, spowodowanym przez niewłaściwe usowanie produktu. Przetwarzanie materiałów pomaga w zachowaniu zasobów naturalnych.



Ten symbol obowiązuje wyłącznie w krajach Unii Europejskiej. Informacje dotyczące prawidłowej metody usunięcia tego produktu, można uzyskać u władz lokalnych lub u dostawcy.

Suomi

- Vanhjojen sähkö- ja elektroniikkalaitteiden hävittäminen (Soveltuva kaikilla Euroopan unionin alueella, sekä muissa Euroopan maissa, joilla on erilliset keräysohjelmat)

Jos tuotteessa tai sen pakkauksessa on tämä symboli, sitä ei pidä hävittäässä käsitellä tavallisena kotitalousjätteenä, vaan se kuuluu toimittaa sähkö- ja elektroniikkalaitteiden kierrätyspisteeseen. Varmistamalla, että tämä tuote hävitetään asiaankuuluvalla tavalla autat estämään mahdollisia ympäristölle ja ihmisille koltuvia negatiivisia seuraamuksia, joita sen vääränlainen hävittäminen voi aiheuttaa. Materiaalien kierrättäminen auttaa säilyttämään luonnonvarjoja.



Tämä symboli on voimassa ainoastaan Euroopan unionin alueella. Jos haluat hävittää tämän tuotteen, ota yhteyttä paikallisiin viranomaisiin tai jälleenmyyjään ja tiedustele asiaankuuluvia hävittäistapoja.

Deutsch

- Entsorgung von elektrischen & elektronischen Altgeräten (geltend für die europäische Gemeinschaft und andere europäische Länder mit separaten Sammelprogrammen)

Dieses Symbol, zu finden auf Ihrem Produkt oder dessen Verpackung, macht Sie darauf aufmerksam, dass dieses Produkt bei der Entsorgung nicht als Hausmüll behandelt werden darf. Statt dessen sollte es an eine Sammelstelle zum Recycling von elektrischen und elektronischen Altgeräten gegeben werden. Helfen Sie mit, potenziell schädliche Einflüsse auf Umwelt und Gesundheit, die durch eine unsachgemäße Entsorgung dieses Produktes entstehen können, zu vermeiden und entsorgen Sie dieses Produkt ordnungsgemäß. Recycling hilft, natürliche Rohstoffe einzusparen.



Dieses Symbol ist nur innerhalb der europäischen Gemeinschaft gültig. Wenn Sie dieses Produkt entsorgen möchten, wenden Sie sich bitte an Ihre örtliche Behörde und fragen Sie nach der ordnungsgemäßen Entsorgungsmethode.

Nederlands

- Verwijderen van oude elektrische en elektronische apparatuur (toepasbaar in de volledige Europese Unie en andere Europese landen met afzonderlijke programma's voor afvalverzameling)

Dit symbool dat op het product of zijn verpakking is aangebracht, geeft aan dat dit product niet mag worden behandeld als huishoudelijk afval als u het wilt wegwerpen. U moet het afgeven bij een specifiek verzamelpunt voor de recyclage van elektrische en elektronische apparatuur. Door te garanderen dat u dit product op de correcte manier wegwerpt, helpt u potentiële negatieve gevolgen voor het milieu en de menselijke gezondheid, die zouden kunnen worden veroorzaakt door een onrechtmatig wegwerpen van het product, te voorkomen. De recyclage van materialen helpt het behoud van natuurlijke bronnen.



Dit symbool is alleen geldig in de Europese Unie. Als u dit product wenst weg te gooien, dient u contact op te nemen met uw lokale instanties voor details over de gepaste methode voor afvalverwijdering.

Waste Electrical and Electronic Equipment (WEEE) Directive In the European Union, this label indicates that this product should not be disposed of with household waste. It should be deposited at an appropriate facility to enable recovery and recycling. EEE complies with Directive 'Regulation on the Restriction of the Use of Certain Hazardous Substances in Electrical and Electronic Equipment'



Waste Electrical and Electronic Equipment (WEEE) Directive In the European Union, this label indicates that this product should not be disposed of with household waste. It should be deposited at an appropriate facility to enable recovery and recycling. EEE complies with Directive 'Regulation on the Restriction of the Use of Certain Hazardous Substances in Electrical and Electronic Equipment'

Waste Electrical and Electronic Equipment (WEEE) Yönergeleri Avrupa Birliği'nde bu etiket, ürünün ev elektroniği aletleri atıkları ile imha edilemeyeceğini gösterir. Kurtarmak ve geri dönüşümünü sağlamak için uygun şartlarda saklanması gerekir. EEE Yönetmeliğine Uygundur Ve Elektronik Eşyalarda Bazı Zararlı Maddelerin Kullanımın Sinirlendirilmesine Dair Yönetmelik.



Waste Electrical and Electronic Equipment (WEEE) Yönergeleri Avrupa Birliği'nde bu etiket, ürünün ev elektroniği aletleri atıkları ile imha edilemeyeceğini gösterir. Kurtarmak ve geri dönüşümünü sağlamak için uygun şartlarda saklanması gerekir. EEE Yönetmeliğine Uygundur Ve Elektronik Eşyalarda Bazı Zararlı Maddelerin Kullanımın Sinirlendirilmesine Dair Yönetmelik.

## Normal Usage Guidelines

Normal use of the LCD is defined as operating in the open air to prevent heat buildup, and without direct or indirect heat sources such as lighting fixtures, heating ducts, or direct sunlight that can cause the modules to experience high operating temperatures. For all modules, do not block fans or ventilation openings. If the LCD module will be installed in a recessed area with an LCD surround or enclosure, ensure adequate openings are applied for proper air flow and ventilation.

At 2000 meters or below, the maximum ambient operating temperature for the LCD module cannot be above 40° C nor below the minimum ambient operating temperature of 5° C. If one of these conditions exists, it is up to the installer to ensure that module placement is changed, thermal shielding is provided and/or additional ventilation is provided to keep the display within its nominal operating parameters.

### Cooling Requirements

For optimal performance, active cooling by the installer should be planned for when the ambient temperature at the top of the wall is predicted to be above the specified ambient temperature for the panel. Cooling may be done behind the displays and depending on the wall configuration, it may be helpful to place air ducts (AC) at every third display tall.

## VESA Mounts, General Description

VESA mounts are used to secure the EP4650/EP5550 for display. The EP4650/EP5550 can be installed using a variety of VESA mounts available through Planar. If you do not have a VESA mount and would like to purchase one, contact Planar.

If you purchased a VESA mount, you should have received a separate box with mounting supplies and an Installation manual. Follow these instructions carefully.

Keep in mind the following general installation guidelines:

- Screw length is crucial and will vary depending on the type of mount you use. Total screw length will include the penetration length plus the length required by the type of VESA mount in use.

**Caution:** Shorter screws will result in insufficient mounting strength and longer screws could puncture parts inside the display.

- Prior to installation, make sure you know where all of the mounting points are located.
- Follow all safety precautions outlined in the VESA Installation manual.
- Verify the parts received with the list shown in the VESA Installation manual.

## Cleaning the EP4650/EP5550

If dust has collected on the power plug, removed the plug from the outlet and clean off the dust. Dust build-up may cause a fire.

Remove the power plug before cleaning. Failure to do so may result in electrical shock or damage.

Keep the following points in mind when cleaning the surface of the EP4650/EP5550:

- When the surface of the EP4650/EP5550 becomes dirty, wipe the surface lightly with a soft clean cloth.
- If the surface requires additional cleaning, use LCD screen cleaner or LCD wipes, which are available at most electronics stores.
- Do not let cleaner seep into the EP4650/EP5550, as it may cause electrical shock or damage.

# Package Contents

## Unpacking the EP4650/EP5550

The EP4650/EP5550 is packed in a cardboard box and may be banded as part of two types of custom pallets, depending on the number of displays shipped. The EP4650/EP5550 is packed using foam to protect it during shipping.

Before unpacking the EP4650/EP5550, prepare a stable, level and clean surface near a wall outlet.

- 1** Place the LCD panel box in an upright position and remove the carton locks from the bottom first.
- 2** Remove the entire top of the box and the top shipping foam.

### 3 Remove the accessory bag and packing list.

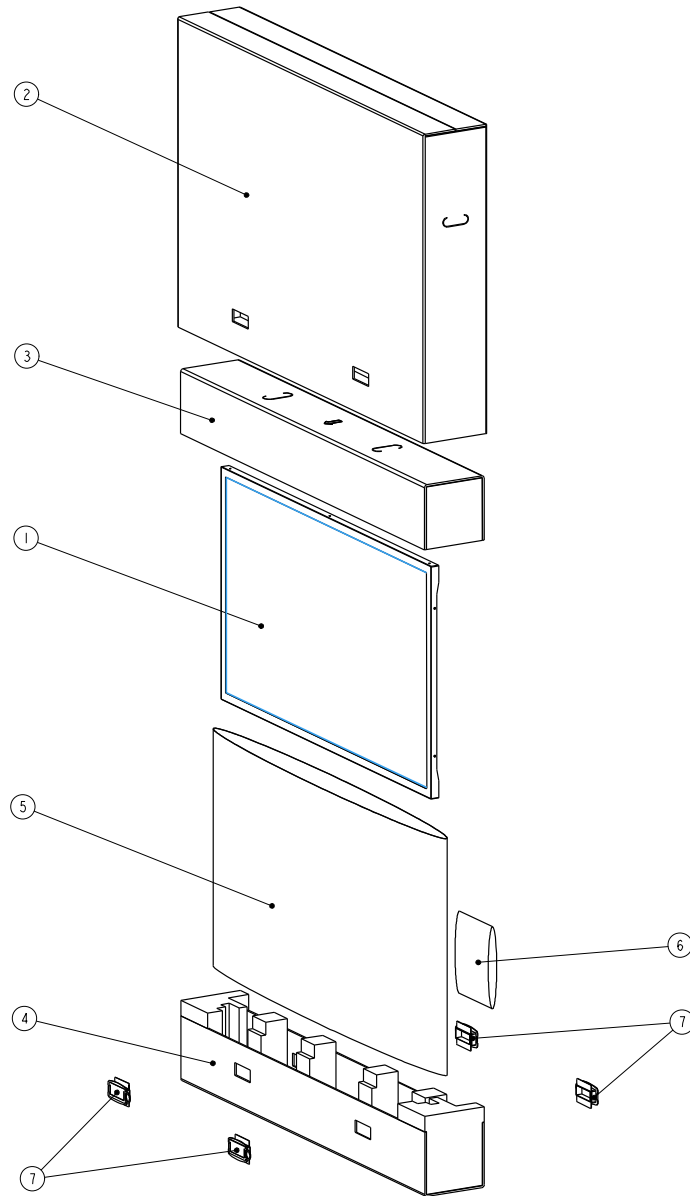

Item	Description	Quantity
1	LCD panel	1
2	Carton	1
3	Foam Cushion Top	1
4	Foam Cushion Bottom	1
5	Polyurethane Bag	1
6	Accessory Bag	1
7	Carton Lock	4

## Contents of the Accessory Kit

Part	Picture	Quantity
VGA Cable (D-sub)		1
USB Drive		1
Power cord		1
IR extender cable		1
OSD Remote (AAA batteries included)		1



# Dimensions

## EP4560 - Front

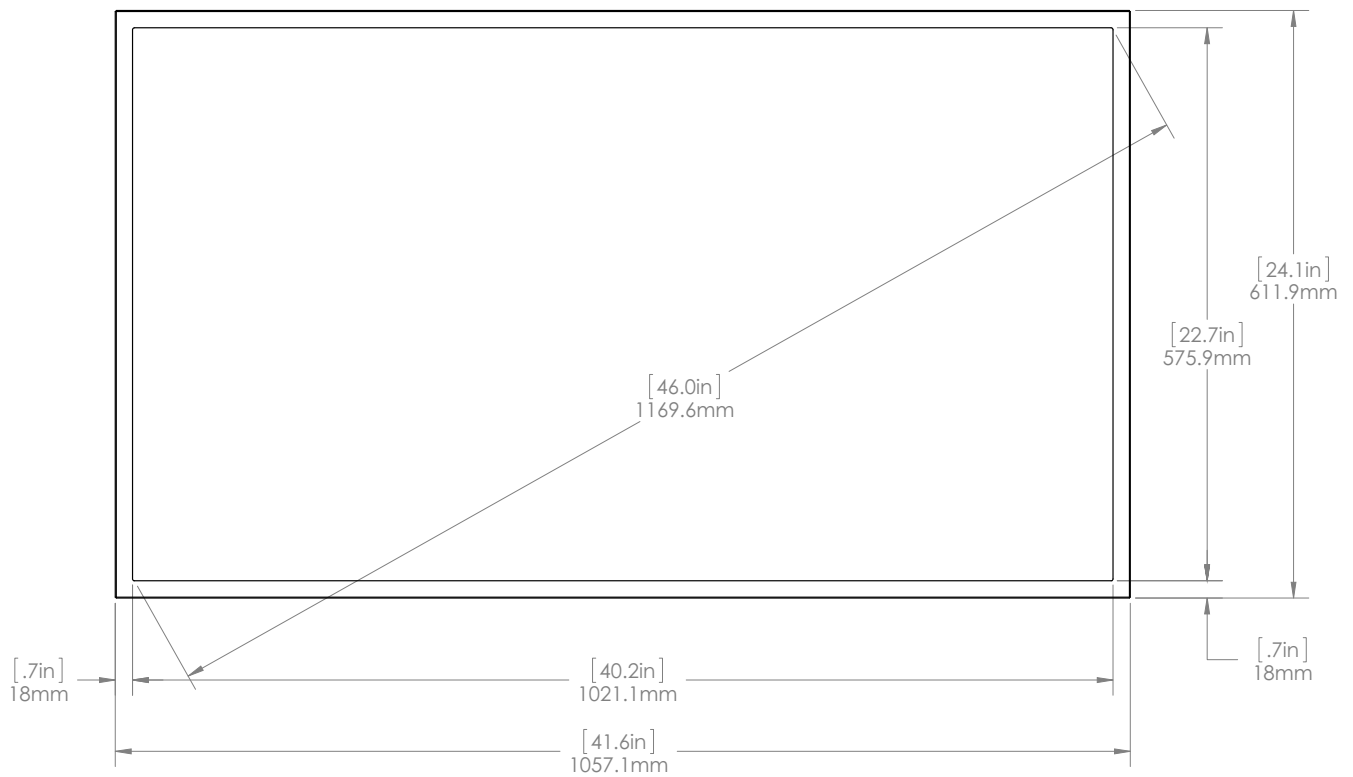

# EP4560 - Rear

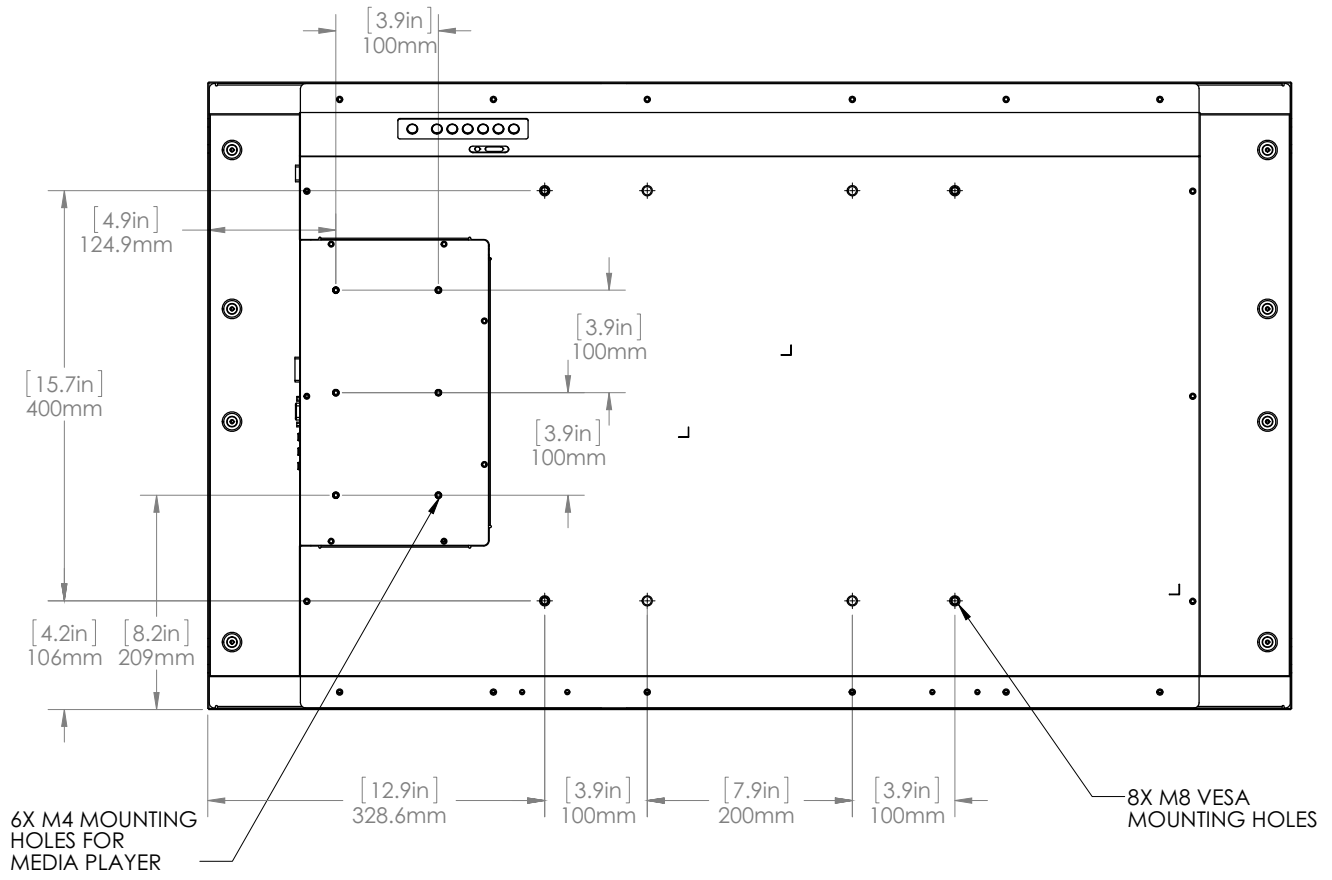

# EP4560 - Side

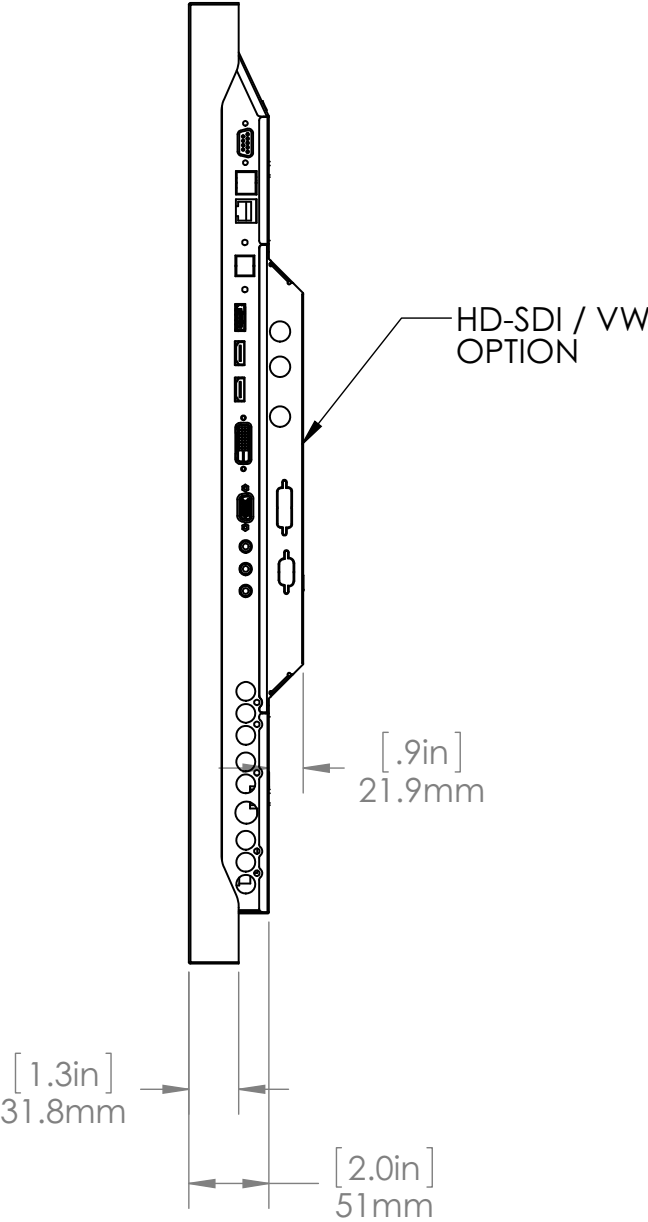

## Standard Inputs

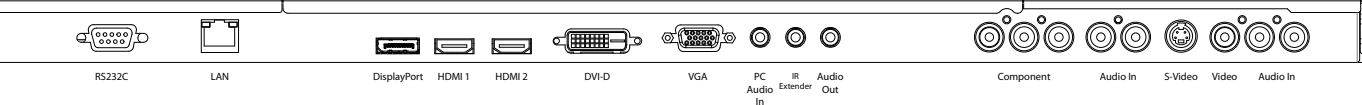

## Optional HD-SDI/VW Inputs



SDI IN



SDI IN



SDI OUT

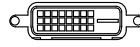

DVI OUT



VGA OUT

## EP5550 - Front

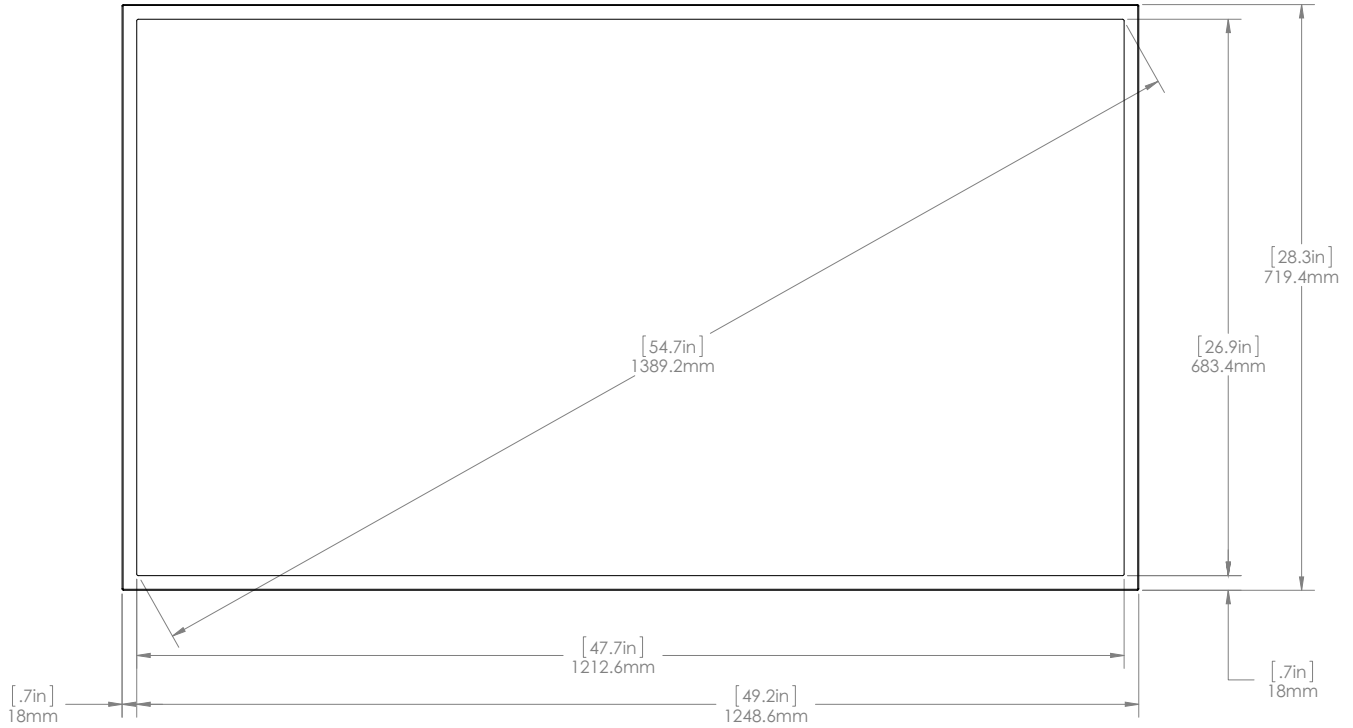

# EP5550 - Rear

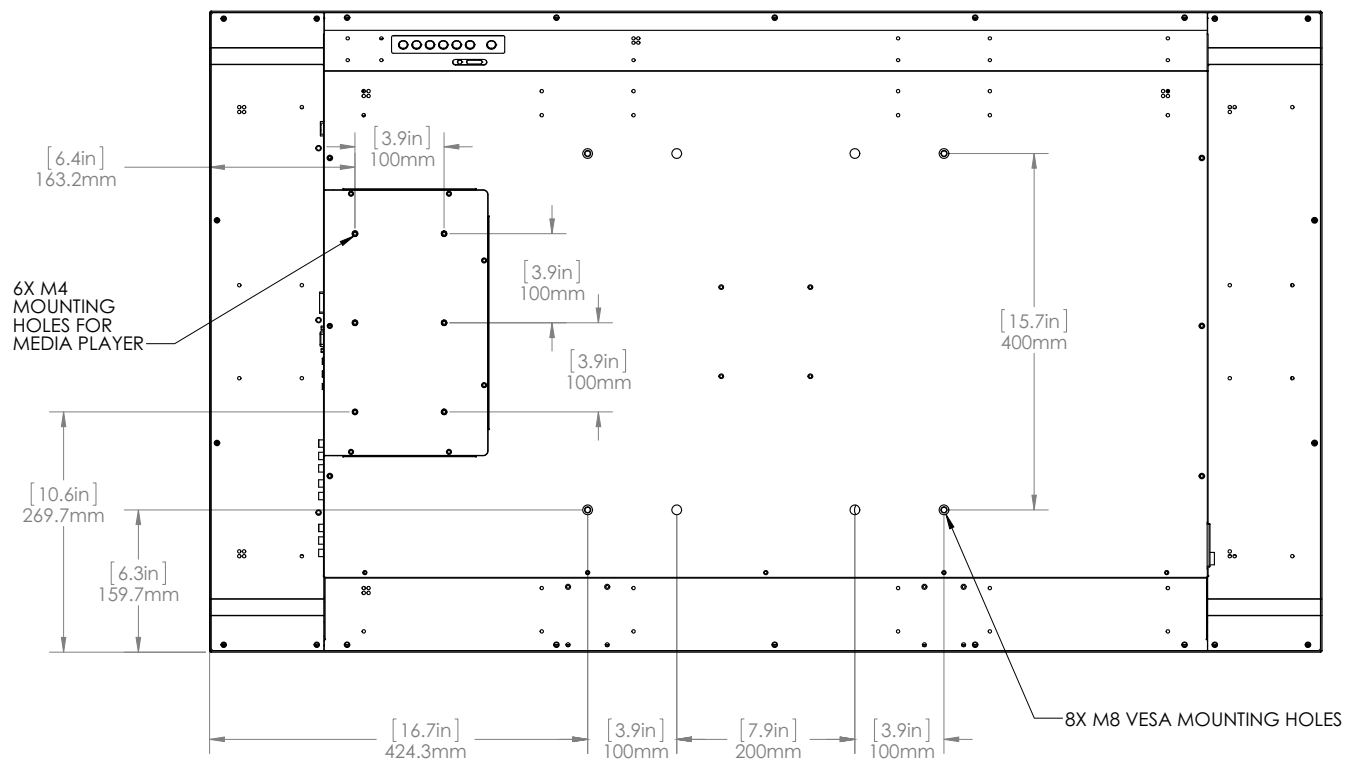

# EP5550 - Side

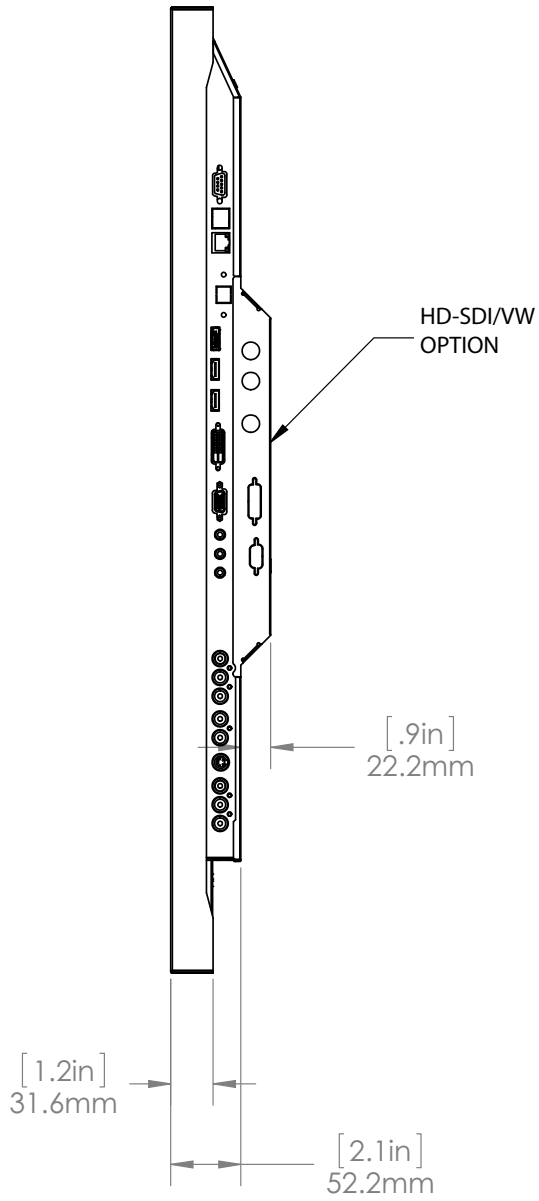

# Installing an EP4650/EP5550

This section explains how to install an EP4650/EP5550. We suggest that you read the entire section before you attempt to install the unit.

## Before You Begin

Make sure you have all the items in these lists before you begin unpacking and installing your EP4650/EP5550(s).

### Tools/Equipment List

Depending on your installation, you may need one or more of the following items:

- String/string level
- Digital/laser level
- Ladders/lift
- Back brace
- Stud finder (if hanging display on a wall)

### Other Things You May Need

- LCD screen cleaner or LCD wipes - available at most electronics stores
- At least two very strong people to help lift units into place

### Plan Your Installation

You should have a detailed plan of how the units are to be configured. The plan should include calculations for the following:

- Power (maximum of five units per 20A circuit for 115V operation)
- Cable runs
- Ventilation and cooling requirements
- If hanging display on a wall, location of studs in the wall

## Prepare Your Installation Location

You should have prepared the area where you will install the unit. If custom enclosures are part of the installation, they must be fully designed to accommodate the installation of the displays, as well as the installed unit and ventilation and cooling requirements.

If your installation included a lot of construction or dust, it is **highly recommended** that you clean all of the screens after the wall installation and configuration are complete.

## Power Input

### Signal Source Input

Source inputs are located on the rear of the display.

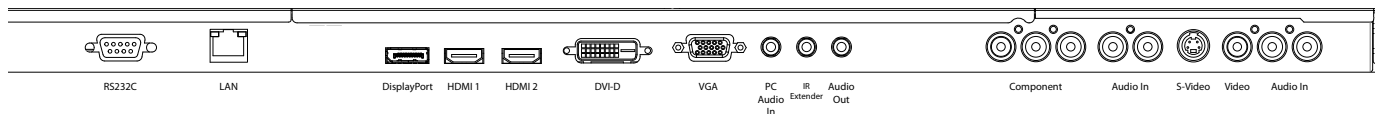

	Name	Connector
	RS232C input	D-Sub 9-pin
	LAN input	RJ45
	DisplayPort	DisplayPort
	HDMI 1 input	HDMI
	HDMI 2 input	HDMI
	DVI-D input	D-Sub 24-pin
	VGA (PC) input	D-Sub 15-pin
	PC audio in	Mini jack
	IR Extender	Mini jack
	Audio Out	Mini jack
	Y-Pb-Pr (Y-Cb-Cr) input	RCA G/B/R
	Audio In for Component input	RCA L/R
	S-video input	Mini Din 4-pin
	Video (composite) input	RCA
	Audio In for S-Video/Video input	RCA L/R



# Operating the EP4560/EP5550

## OSD Keypad

The OSD keypad is located on the rear of the display.

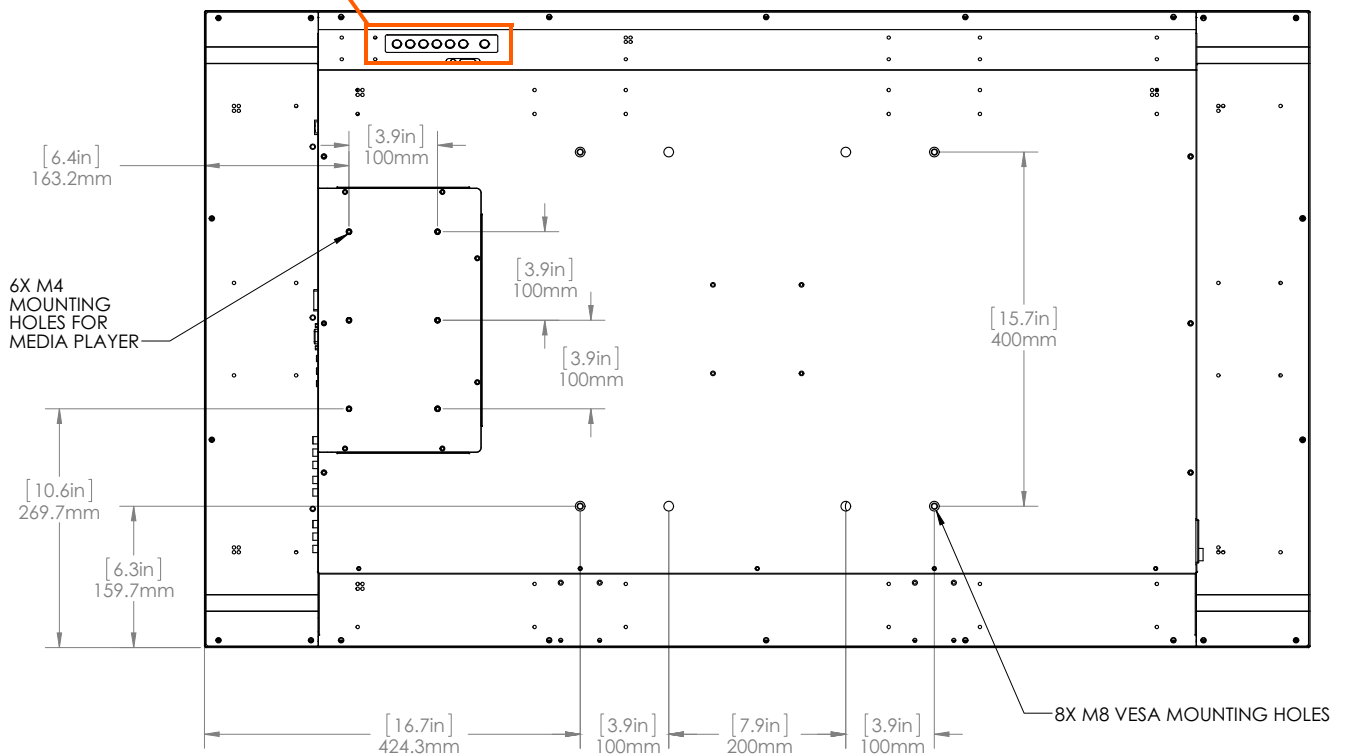

### OSD Keypad Buttons

Key	Descriptions
Power	Power on/Power off
Source	Source selection (toggle)

### OSD Keypad Buttons

▶	Menu Right/Increase value
◀	Menu Left/Decrease value
▲	Menu Up
▼	Menu Down
Menu/Exit	Menu/Exit

## Remote Control Receiver

The remote control receiver is located near the keypad on the rear of the display. Use the IR extender cable for operating the remote from the front of the display.

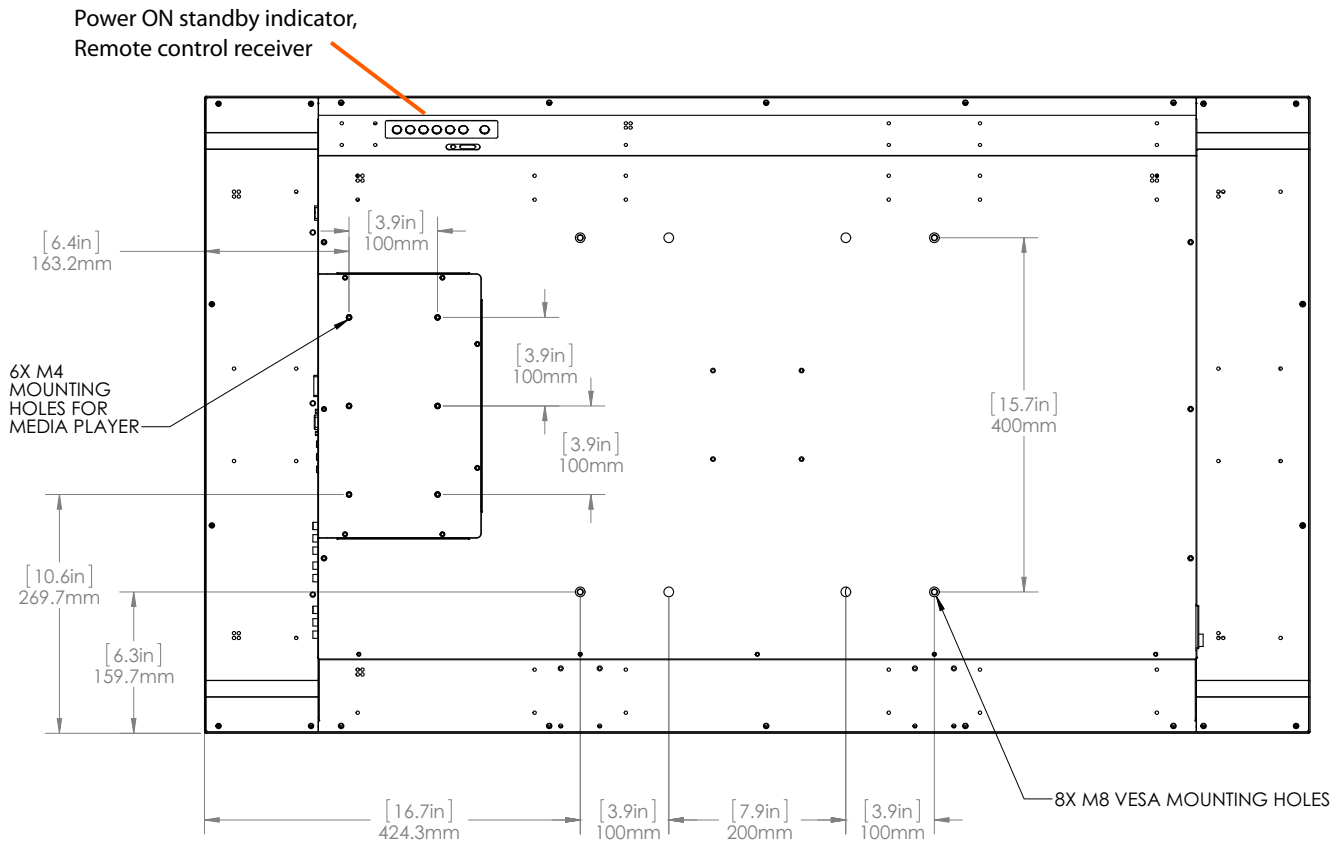

## LED Indicators

The LED indicator light is located on the rear of the display near the keypad. The following table explains what the different colors and blink patterns mean.

**LED On**

<b>Power Status</b>	<b>Condition</b>
Green	Power on
Blinking Orange	No signal
Orange	Power saving mode
Off	AC off
Off	Power off

## Using the Display in Portrait Mode





When using the display in the portrait position and looking at the rear of the display, it should be rotated according to the arrow stickers on the back of the display. This will allow for proper ventilation. Then select the OSD rotation of landscape or portrait on the OSD menu (MAIN MENU > BASIC > OSD ROTATION).

**Caution:** Improper ventilation may shorten the life of the display.

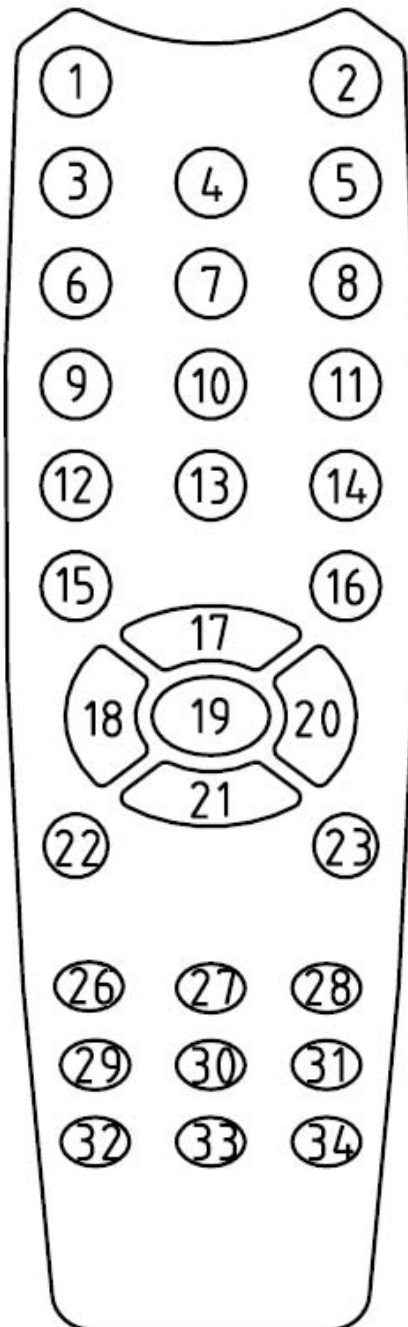
## Using the Remote Control

Below is a picture of the remote control and its corresponding Hex codes. See the following page for button descriptions and Hex codes.



Num	Function	Customer Code	Hex Code	Description
1	INFO	40AF	04FB	Provides source and resolution information
2		40AF	1CE3	Turns the EP4650/EP5550 on and off
3	VGA	40AF	07F8	Selects the PC's VGA source
4	DVI	40AF	08F7	Selects the PC's DVI source
5	HDMI 1	40AF	09F6	Selects the HDMI source 1
6	COMP	40AF	0AF5	Selects the Component source
7	AV	40AF	0BF4	Selects the Composite video source
8	HDMI 2	40AF	0CF3	Selects the HDMI source 2
9	P-position	40AF	1AE5	Selects the PIP position
10	DisplayPort	40AF	15EA	Selects the DisplayPort source
11	SDI 1	40AF	10EF	Selects the HD-SDI source 1
12	PIP	40AF	11EE	Turns the PIP feature on and off
13	S-V	40AF	0DF2	Selects the S-Video source
14	SDI 2	40AF	16E9	Selects the HD-SDI source 2
15	SWAP	40AF	06F9	Swaps the main source & sub source picture
16	P-SOURCE	40AF	13EC	Selects the secondary subsource
17		40AF	02FD	Navigates up through submenus and settings
18		40AF	01FE	Navigates back through submenus and settings
19	MENU	40AF	0EF1	Opens the EP4650/EP5550's on-screen menu system. When the menu system is already open, pressing this button will select the previous submenu.
20		40AF	03FC	Navigates forward through submenus and settings

Num	Function	Customer Code	Hex Code	Description
21	▼	40AF	19E6	Navigates down through submenus and settings
22	ENTER	40AF	12ED	Selects highlighted menu choices
23	EXIT	40AF	05FA	Closes the menu system
26	SCALING	40AF	14EB	Toggles between different aspect ratios (Auto, Native, 4 x 3, 16 x 9, 16 x 10 and Letterbox)
27	FREEZE	40AF	43BC	Freezes the current source image
28	MUTE	40AF	00FF	Turns off the sound
29	BRIGHT	40AF	17E8	Adjusts the brightness
30	CONTRAST	40AF	18E7	Adjusts the contrast
31	AUTO	40AF	1EE1	Synchronizes the EP4650/EP5550 to the source
32	SOURCE	40AF	0FF0	Allows selection of the different sources
33	VOLUME -	40AF	1BE4	Decreases the sound volume
34	VOLUME +	40AF	1DE2	Increases the sound volume

## Locking/Unlocking the OSD Menu

You can lock or unlock the OSD menus by pressing a series of key commands on the remote control. To **lock** the menu, press the following keys on the remote in the order listed: ENTER, ENTER, EXIT, EXIT, ENTER and EXIT. To **unlock** it, simply follow the same sequence.

Depending on whether you locked or unlocked the menu, you will see one of the following messages on the screen.



## Changing the Remote Control Battery

- 1 Remove the battery cover.**  
Slide back and remove the battery cover in the direction of the arrow.

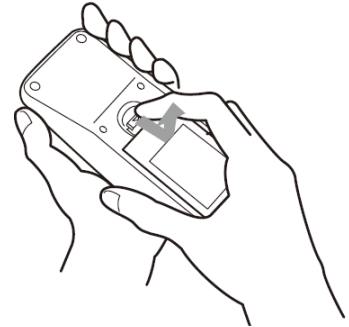

- 2 Insert the batteries.**  
Align and insert two AAA batteries according to their plus and minus ports (as indicated in the remote control).

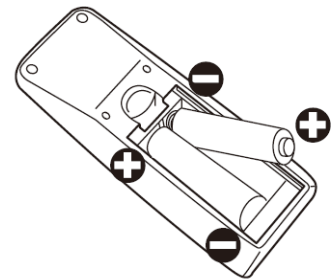

- 3 Close the battery cover.**  
Replace the battery cover in the direction of the arrow and snap it back into place.

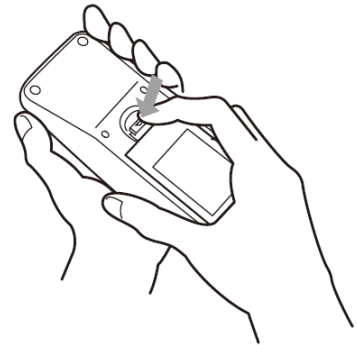

## Turning the EP4650/EP5550 On

- 1** Insert the power cord into EP4650/EP5550 and into the power outlet.
- 2** Ensure the AC switch is set to “—”.
- 3** Press the power button on the remote or side control panel.

## Turning the EP4650/EP5550 Off

With the power on, press the power button on the remote or side control panel to put the LCD panel in a standby mode. To turn off power completely, turn the AC switch to "O" or disconnect the AC power cord from the power outlet.

**Note:** If there is no signal for a certain period of time, the LCD panel will automatically go into standby mode.

## Adjusting the Volume

- 1 Using the remote, press the VOLUME - or VOLUME + to increase or decrease the volume.
- 2 Press the MUTE button to temporarily turn off all sound. To restore the sound, press the MUTE button again.



## Selecting the Input Source

- 1 Do one of the following:
  - Using the remote, press the desired source button (VGA, HDMI 1, HDMI 2, DISPLAYPORT, VIDEO (COMPOSITE), S-V (S-VIDEO), COMPONENT, SDI 1 OR SDI 2).
  - Press the source button on the EP4650/EP5550's keypad. Use the arrow buttons (▲ ▼) to select one of the following input sources and press ENTER: VGA, HDMI 1, HDMI 2, DVI, DISPLAYPORT, COMPOSITE VIDEO, S-VIDEO, COMPONENT, SDI 1 OR SDI 2.

Standard Inputs

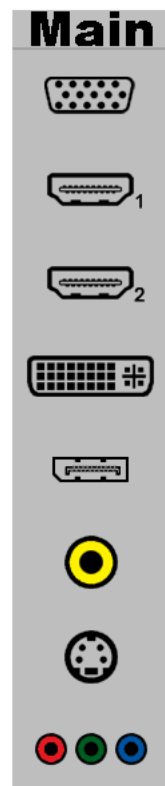

Standard Inputs Plus Optional SD-HDI



**Note:** When the EP4650/EP5550 cannot find a source, a “No signal” message will appear.

Main No signal

Going to Sleep

## PIP Mode

The Picture-in-Picture mode displays a separate image within a smaller window in addition to the main source picture that is displayed on most of the display.

- 1 Select the main source:** Using the remote, press the desired source button (VGA, HDMI 1, HDMI 2, COMP, VIDEO [composite] or S-V [s-video]).
- 2 Turn on PIP:** Using the remote, press PIP.

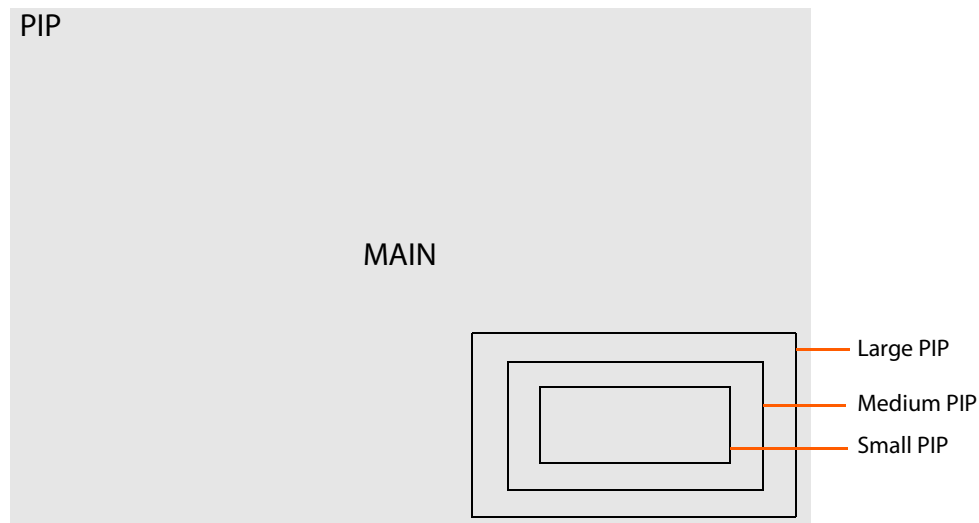

- 3 To select the PIP/ subsource:** Using the remote, press P-SOURCE and use the arrow buttons (▲ ▼) to navigate to the desired subsourse. Press ENTER.
- 4 To change the size and position of the subsourse:** Using the remote, press P-POSITION to toggle through the options.

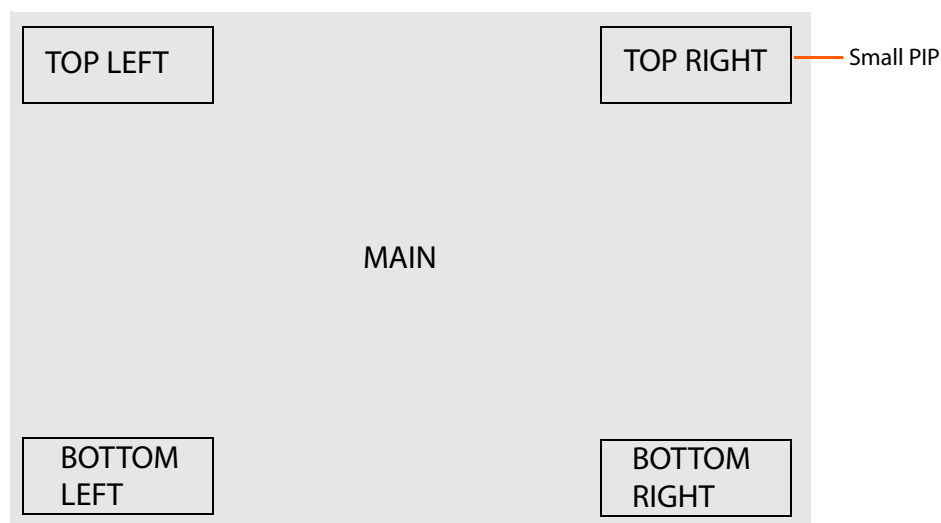

- 5 To switch the main source and the subsource:** Using the remote, press SWAP.

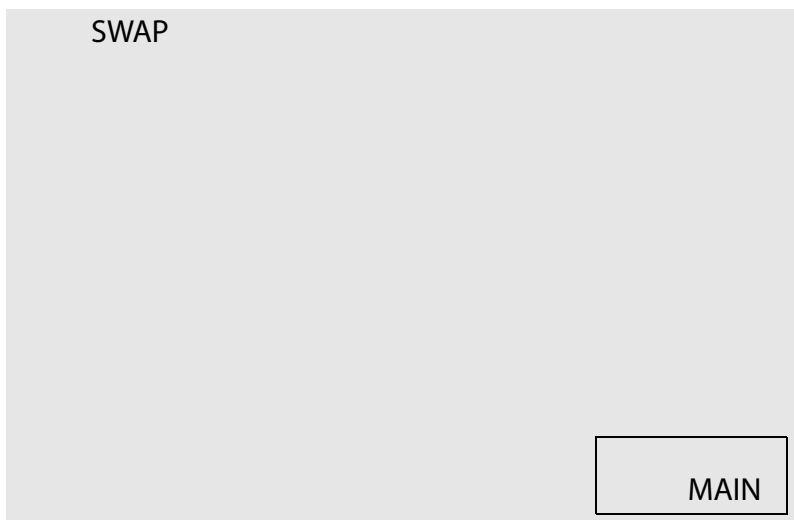

- 6 To switch audio between the main source and the subsource:** Using the remote, press AUDIO.
- 7** For additional PIP functionality, press MENU and navigate to the DISPLAY SETTINGS menu. Use the arrow buttons (▲ ▼) to navigate to the desired PIP feature and press ENTER. Press ► to toggle through the associated options and press ENTER to select the highlighted option.

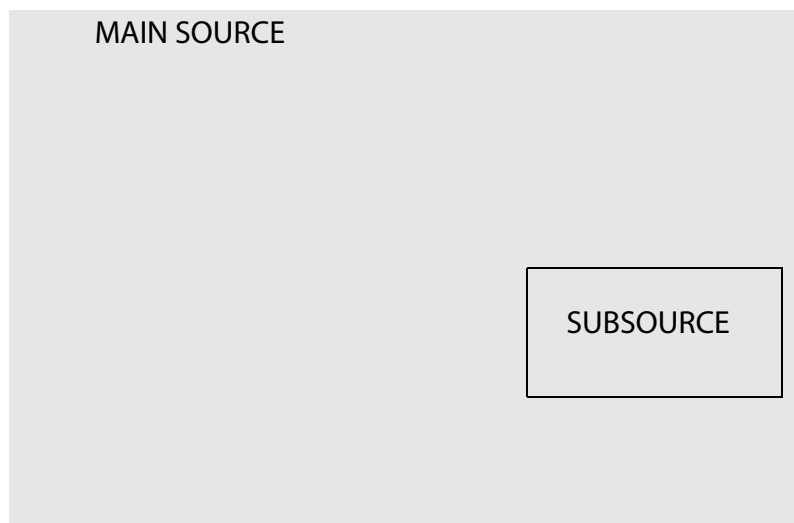

- 8 Side by Side:** Press the P-POSITION button and then “Side by side” mode. The main source and the subsource will be on the screen display.

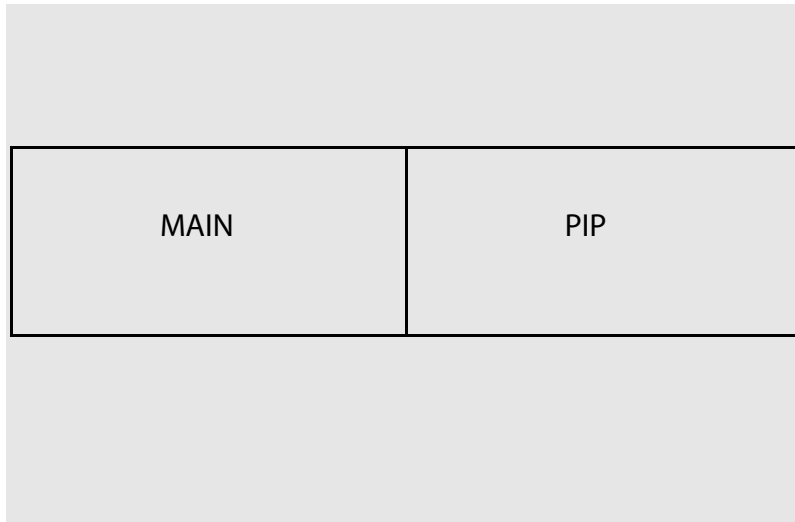

### PIP Screen Table

The following table shows sources that can be displayed in a PIP window when sources in the main window are displayed.

		PIP									
		VGA	HDMI 1	HDMI 2	DVI	Display Port	Video (Composite)	S-Video	Component	HD-SDI 1	HD-SDI 2
<b>M a i n</b>	VGA		Yes	Yes	Yes	Yes	Yes	Yes	Yes	Yes	Yes
	HDMI 1	Yes				Yes	Yes	Yes	Yes	Yes	Yes
	HDMI 2	Yes				Yes	Yes	Yes	Yes	Yes	Yes
	DVI	Yes				Yes	Yes	Yes	Yes	Yes	Yes
	DisplayPort	Yes	Yes	Yes	Yes		Yes	Yes	Yes	Yes	Yes
	Video	Yes	Yes	Yes	Yes	Yes			Yes	Yes	Yes
	S-Video	Yes	Yes	Yes	Yes	Yes			Yes	Yes	Yes
	Component	Yes	Yes	Yes	Yes	Yes	Yes	Yes		Yes	Yes
	HD-SDI 1	Yes	Yes	Yes	Yes	Yes	Yes	Yes	Yes		
HD-SDI 2	Yes	Yes	Yes	Yes	Yes	Yes	Yes	Yes			

## OSD Menu Functions

There are two menu modes: Graphics (DVI and VGA) and Video (HDMI and DisplayPort). Any differences are notes in the table.

Main Menu	Submenu	Secondary Menu	Description	Setting
Image Settings	Scheme		In Video mode, select the scheme  <b>Note:</b> Disabled in Graphics mode	User, Vivid, Cinema, Game, Sport
	Brightness		Adjust the brightness of the screen	0~100
	Contrast		Adjust the contrast of the screen	0~100
	Sharpness		Adjust the sharpness of the screen	0~24
	Saturation		Adjust the saturation of the screen  <b>Note:</b> Disabled in Graphics mode	
	Hue		Adjust the hue of the screen  <b>Note:</b> Disabled in Graphics mode	
	Backlight		Adjust the backlight	0~100
	Color Temp & Gamma	Gamma	Select the Gamma	1.85, 1.9, 1.95, 2.0, 2.05, 2.1, 2.15, 2.2, 2.25, 2.3, 2.35, 2.4, 2.45, 2.5, 2.55, 2.6, Off
		Color Temp	Select the Color Temp	3200, 5000K, 6500K, 7500K, 9300K, User
		Red Gain	Select the Red Gain	128~383
		Green Gain	Select the Green Gain	128~383
		Blue Gain	Select the Blue Gain	128~383
		Red Offset	Select the Red Offset	-50~50
Green Offset		Select the Green Offset	-50~50	
	Blue Offset	Select the Blue Offset	-50~50	

Main Menu	Submenu	Secondary Menu	Description	Setting
Display Settings	Main	Aspect Ratio	Adjust the aspect ratio of the screen	Full screen, Pillar Box, Letter Box, Native
		Zoom	Adjust the zoom function	▶ ◀
		Auto Scan	Select the Auto scan function	Off, On
		Select Source	Select the main input source	VGA, HDMI 1/2, DisplayPort, DVI, Comp, S-V (s-video), Video (composite)
Display Settings	PIP	PIP Mode	Select the PIP mode	Off, Large PIP, Medium PIP, Small PIP, Side by Side
		PIP Position	Select the PIP location	Bottom-Right, Top-Left Top-Right, Bottom-Left
		Aspect Ratio	Adjust the aspect ratio of the screen	Full screen, Pillar Box, Letter Box
		Side by Side Scale		▶ PIP
				◀ Main
				▲ Zoom IN
				▼ Zoom Out
				Enter: Default
				Menu: Return
	Auto Scan	Select the Auto scan function	Off, On	
	Select Source	Select the main input source when PIP mode is enabled	VGA, HDMI 1/2, DisplayPort, DVI, Comp, S-V (s-video), Video (composite)	
Audio Settings	Volume		Adjust the volume	0~100
	Bass		Adjust the Bass volume	0~20
	Treble		Adjust the Treble volume	0~20
	Balance		Adjust the balance of the screen	0~20
	HDMI Audio Input		Audio input control	HDMI/PC
	DP Audio Input		Audio input control	DisplayPort/PC
	Internal Speakers		Disable internal audio speakers	On, Off

Main Menu	Submenu	Secondary Menu	Description	Setting
Basic Settings	OSD Transparent		Adjust the OSD transparent function	0~100
	OSD Location		Adjust the OSD location	▶,◀,▲,▼
	OSD Zoom		Adjust the OSD size (Disable in portrait type)	Off, On
	OSD Rotation		Adjust the OSD rotation	Landscape/Portrait
	OSD Language		Select the OSD language	English/ Chinese
	OSD Timeout		Select the OSD timeout seconds	5~120 sec.
	Sleep Timer		Select the sleep timer	Off, 15, 30, 60, 90, 120 Min.
	Power LED		LED on rear of display shows powered on/off or standby mode	Off, On
Basic Settings	Real Time Clock (RTC)			
		Current Mode	Set up Date & Time	
		Timer Mode	Set up schedule	User, Work Days, All Days
Advanced Settings	Auto Adjustment		Select the Auto adjustment function	Off, On
	Image Position		▶ 0~ -100 ◀ 0 ~ 100 ▲ according to resolution ▼ according to resolution	
	Phase		0~63	According to resolution
	Clock		0~100	According to resolution
	VGA ADC Settings	ADC Mode	Select ADC mode	Default, User
		User ADC Calibration	Perform an ADC calibration	Yes, No
		Restore ADC to Default	Reset the default ADC settings	Yes, No
	Flesh Tone		Use to amplify all colors except of people's faces  <b>Note:</b> Disabled in Graphics mode	Off, Low, Medium, High
	IRFM		Select the anti burn-in mode function	Off, On
	Baud rate		Setting the baud rate of the display	115200, 38400, 19200, 9600

Main Menu	Submenu	Secondary Menu	Description	Setting
Advanced Settings	Smart light control		Select the Backlight control function DCR (Dynamic contrast) – from the input source Light Sensor – from ambient light	Off, DCR, Light Sensor
	Wake Up From Sleep		Energy-saving function	Never Sleep VGA Only VGA, Digital, RS232
	Ethernet Setup	Enable Network	Enable the network feature	Yes, No
		Dynamic IP	Enable the Dynamic IP mode	Disable, Enable
		Static IP Address	Set the static IP address	255.255.255.255 (0.0.0.0)
		Subnet Mask	Set the subnet mask	255.255.255.255 (0.0.0.0)
		Gateway	Set the gateway address	255.255.255.255 (0.0.0.0)
		DNS Address	Set the DNS address	255.255.255.255 (0.0.0.0)
		Save Network Settings	Update the IP settings to the net device	Yes, No
		Load Default Settings	Load the default network settings	Yes, No
		Device MAC	Show the unique address assigned to network interfaces	
	Multi-Display Control	Monitor ID	Manually select the Monitor ID of each display	1~25
		Video Wall	Disable/Enable Video Wall	Yes, No
		DVI Indemnity	Used for large video walls that have a single digital source and DVI pass-thru cables. Turning on DVI Indemnity may enhance the video quality and reliability of pass-thru signals.	Off, On
		Power On Delay	Select the Power On delay in seconds for each display in the video wall	0~1.50 (in .05 second increments)
		Frame	Disable/Enable Frame compensation	Yes, No
		Matrix X	Sets the number of displays used in the horizontal position	1~5



Main Menu	Submenu	Secondary Menu	Description	Setting
Advanced Settings	Multi-Display Control	Matrix Y	Sets the number of displays used in the vertical position	1~5
		Division X	Sets the horizontal position of the display wall matrix	1~ Matrix X
		Division Y	Sets the vertical position of the display wall matrix	1~ Matrix Y
	Factory Reset		Reset to the factory default setting	Yes, No
System Status	Channel Information	Source	Show the name of the input source	
		Resolution	Show the current resolution	
		Firmware Version	Show the firmware of the LCD	

# OSD Menus

## Image Settings

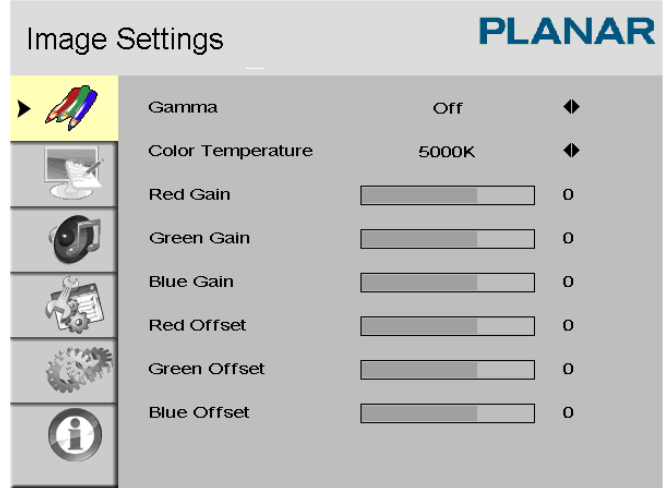
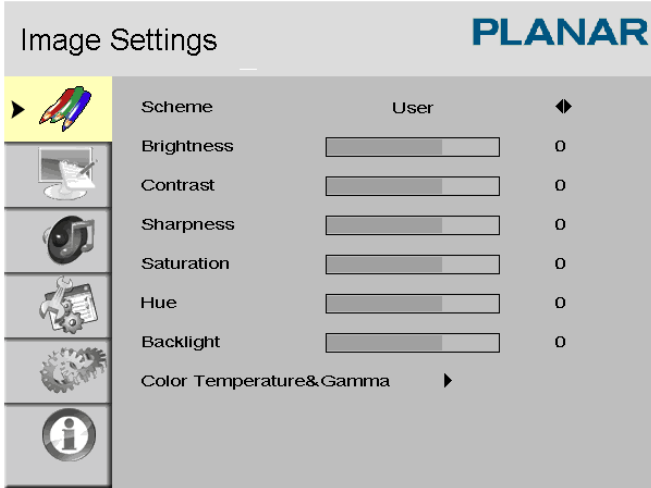

## Display Settings

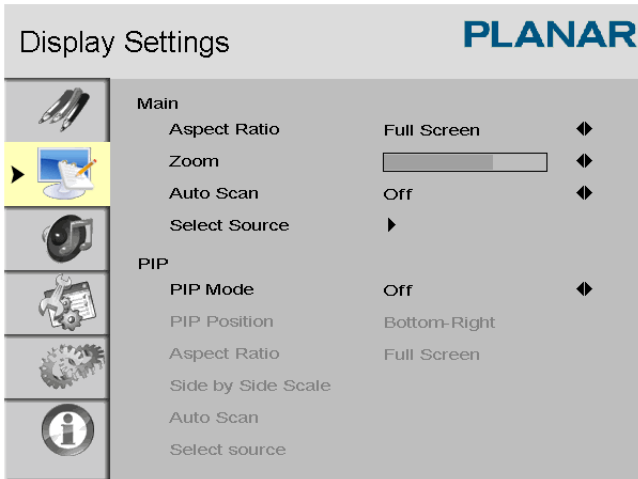

Main

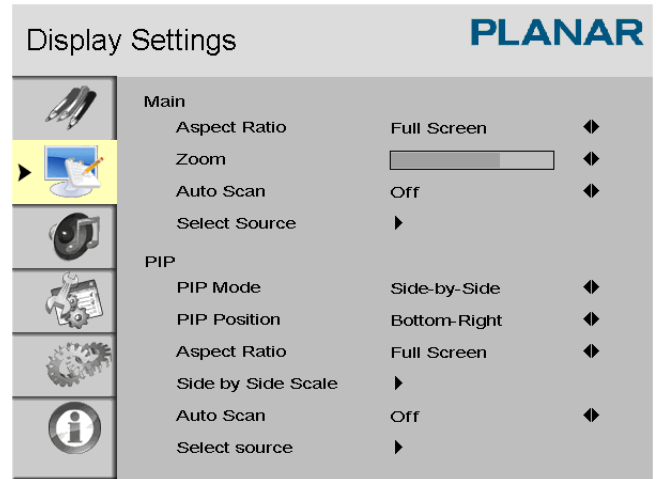

PIP

## Audio Settings

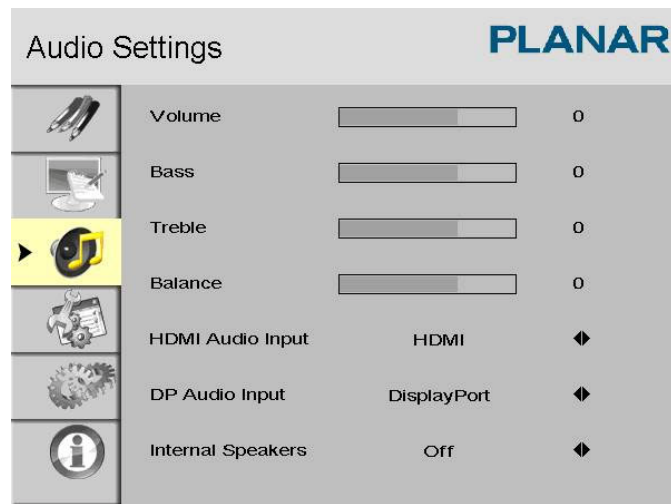

## Basic Settings

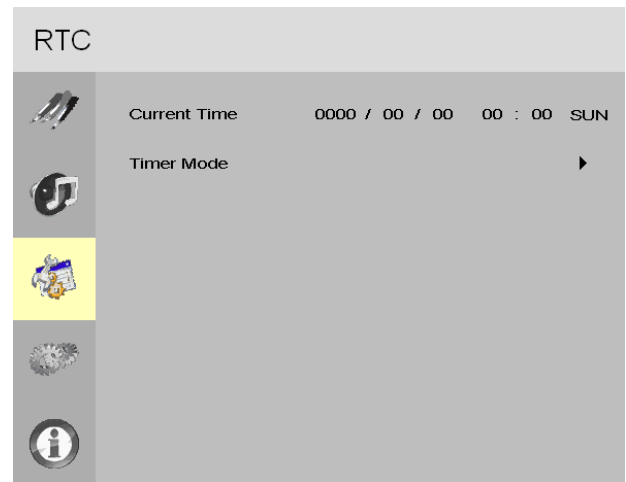
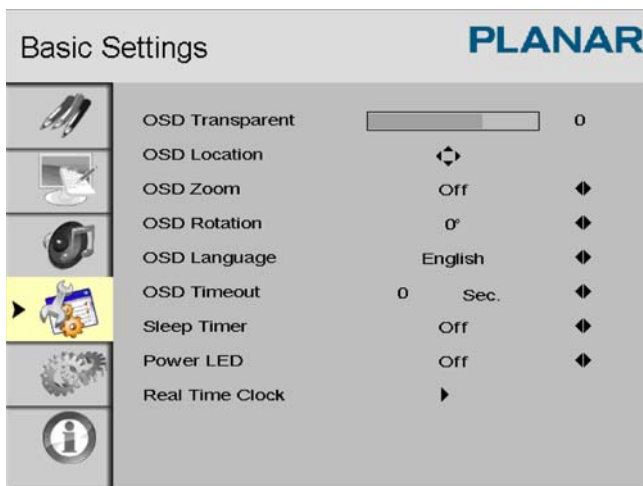

### RTC Submenus

RTC

Timer Mode	User	Enable	Power On	Power Off
MON		<input type="checkbox"/>	00 : 00	00 : 00
TUE		<input type="checkbox"/>	00 : 00	00 : 00
WED		<input type="checkbox"/>	00 : 00	00 : 00
THU		<input type="checkbox"/>	00 : 00	00 : 00
FRI		<input type="checkbox"/>	00 : 00	00 : 00
SAT		<input type="checkbox"/>	00 : 00	00 : 00
SUN		<input type="checkbox"/>	00 : 00	00 : 00

User Mode

RTC

Timer Mode	Same Settings On Work Days	Enable	Power On	Power Off
MON-FRI		<input type="checkbox"/>	00 : 00	00 : 00
SAT		<input type="checkbox"/>	00 : 00	00 : 00
SUN		<input type="checkbox"/>	00 : 00	00 : 00

Same Settings On Work Days Mode

RTC

Timer Mode	Same Settings On All	Enable	Power On	Power Off
MON-SUN		<input type="checkbox"/>	00 : 00	00 : 00

Same Settings On All Mode

## Advanced Settings

Advanced Settings **PLANAR**

	Auto Adjustment	No	◆
	Image Position	▶	
	Phase	<input type="text" value="0"/>	0
	Clocks	<input type="text" value="0"/>	0
	VGA ADC Settings	▶	
	Flesh Tone	Off	◆
	IRFM	Off	◆
	Baud Rate	115200	◆
	Smart Light Control	Off	◆
	Wake Up From Sleep	VGA Only	◆
	Ethernet Setup	▶	
	Multi-Display Control	▶	
	Factory Reset	No	◆

## Network Settings

Advanced Settings **PLANAR**

	Enable Network	No	◆
	Dynamic IP	Disabled	◆
	Static IP Address	0 . 0 . 0 . 0	
	Subnet Mask	0 . 0 . 0 . 0	
	Gateway	0 . 0 . 0 . 0	
	DNS Addr.	0 . 0 . 0 . 0	
	Save Network Settings	▶ No Yes	
	Email Alert	▶	
	Load Default Settings	▶ No Yes	
	Device MAC		

## Multi-Display Control

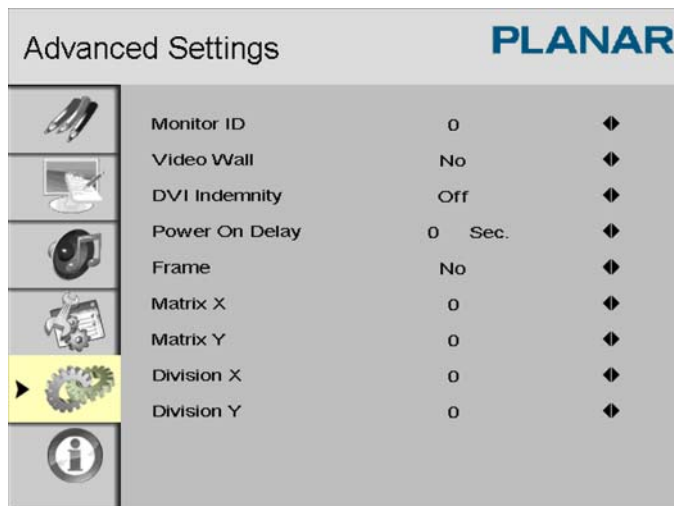

## System Status

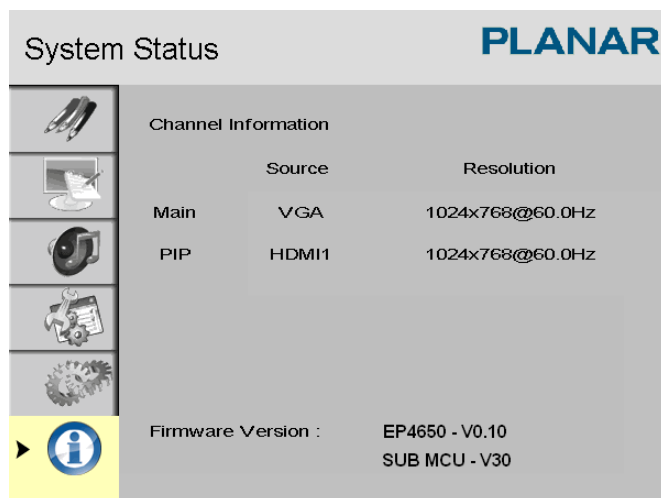

## Navigating Through the Menus

- 1 With the power on, press MENU. The IMAGE SETTINGS menu appears.
- 2 Within the menu, use ▲, ▼, ◀, ▶ and ENTER to navigate through the menus and adjust options.
- 3 Press MENU to return to the previous menu. To exit the menu system, press EXIT.

## Image Settings Menu

This menu is used for making common image adjustments.

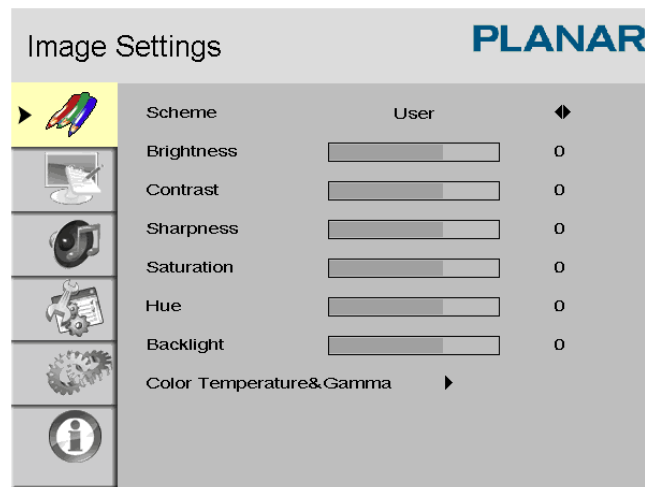

<b>Scheme</b>	
	Press ◀ or ▶ to select one of the following: <b>Options:</b> User, Vivid, Cinema, Game, Sport
<b>Brightness</b>	
	Increases or decreases the brightness of the picture. Press ◀ or ▶, select the desired level, and press ENTER. <b>Range:</b> 0~100
<b>Contrast</b>	
	Increases or decreases the contrast of the picture. Press ◀ or ▶, select the desired level, and press ENTER. <b>Range:</b> 0~100
<b>Sharpness</b>	
	Adjusts the definition of the picture. Press ◀ or ▶, select the desired level, and press ENTER. <b>Range:</b> 0~24
<b>Saturation</b>	
	Adjusts the brilliance and brightness (Video Mode only). Press ◀ or ▶, select the desired level, and press ENTER. <b>Range:</b> 0~100
<b>Hue</b>	
	Increases or decreases the green hue (Video Mode only). Press ◀ or ▶, select the desired level, and press ENTER. <b>Range:</b> 0~100

<b>Backlight</b>	
	<b>Range:</b> 0~100
<b>Color Temp and Gamma</b>	
	Adjusts red, green, blue gain and red, green blue offset.
<b>Gamma</b>	
	<b>Options:</b> Off, 1.85, 1.9, 1.95, 2.0, 2.05, 2.1, 2.15, 2.2, 2.25, 2.3, 2.35, 2.4, 2.45, 2.5, 2.55, 2.6
<b>Color Temp</b>	
	<b>Options:</b> User, 3200K, 5000K, 6500K, 7500K and 9300K.
<b>Red Gain</b>	
	Set Color Temperature to "User Mode" to adjust this setting. <b>Range:</b> 128~383
<b>Green Gain</b>	
	Set Color Temperature to "User Mode" to adjust this setting. <b>Range:</b> 128~383
<b>Blue Gain</b>	
	Set Color Temperature to "User Mode" to adjust this setting. <b>Range:</b> 128~383
<b>Red Offset</b>	
	Set Color Temperature to "User Mode" to adjust this setting. <b>Range:</b> -50~50
<b>Green Offset</b>	
	Set Color Temperature to "User Mode" to adjust this setting. <b>Range:</b> -50~50
<b>Blue Offset</b>	
	Set Color Temperature to "User Mode" to adjust this setting. <b>Range:</b> -50~50



## Display Settings Menu

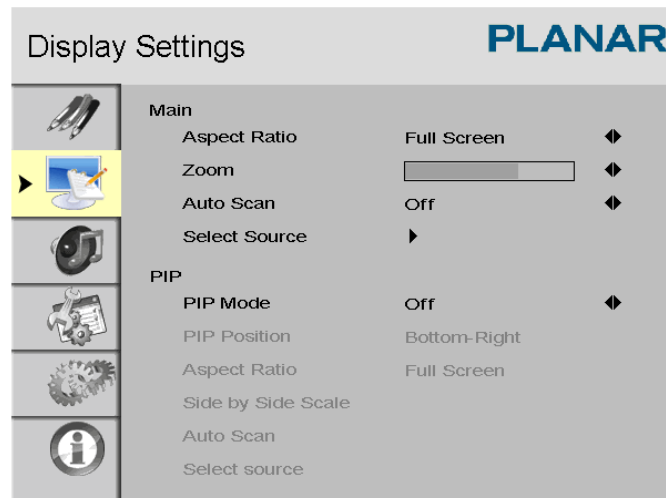

<b>Main</b>	
	Display Setting Mode
<b>Aspect Ratio</b>	
	Changes the picture's aspect ratio Press ◀ or ▶ to select the following options: <b>Options:</b> Full screen, Pillar Box, Letter Box, Native
<b>Zoom</b>	
	<b>Range:</b> 0~10
<b>Auto Scan</b>	
	<b>Range:</b> On, Off
<b>Select Source</b>	
	<b>Options:</b> HDMI 1, HDMI 2, SDI 1, SDI 2, VGA, Component, S-Video and Video (composite)
<b>PIP</b>	
<b>PIP Mode</b>	
	<b>Options:</b> Off, Large PIP, Middle PIP, Small PIP and Side-by-Side
<b>PIP Position</b>	
	<b>Options:</b> Bottom-Right, Top-Left, Top-Right and Bottom-Left

<b>Aspect Ratio</b>	<b>Options:</b> Full screen, Pillar Box, Letter Box
<b>Side by Side Scale</b>	<b>Submenu Options:</b> Zoom In, Zoom Out, Main, PIP, Default and Return
<b>Auto Scan</b>	<b>Options:</b> On, Off
<b>Select Source</b>	<b>Options:</b> HDMI 1, HDMI 2, SDI 1, SDI 2, VGA, Component, S-Video and Video (composite)

## Audio Settings Menu

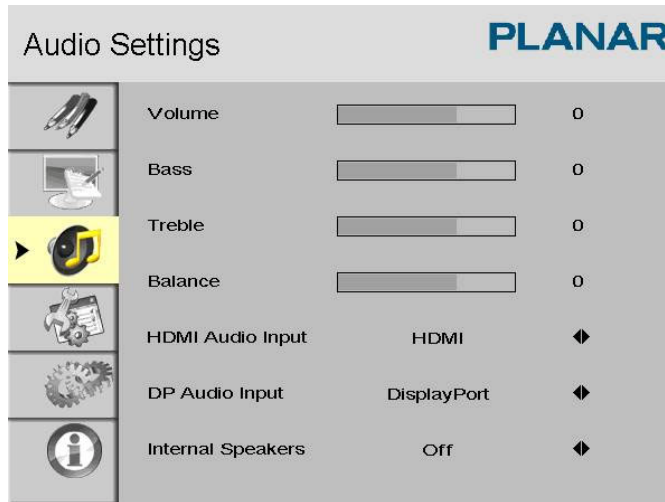

<b>Volume</b>	Adjust the sound. Press ◀ or ▶, select the desired level, and press ENTER. <b>Range:</b> 0~100
<b>Bass</b>	Adjust the low tones (bass). Press ◀ or ▶, select the desired level, and press ENTER. <b>Range:</b> 0~20
<b>Treble</b>	Adjust the high tones (treble). Press ◀ or ▶, select the desired level, and press ENTER. <b>Range:</b> 0~20

<b>Balance</b>	Adjust the balance of the left and right speakers. Press ◀ or ▶ , select the desired level, and press ENTER. <b>Range:</b> 0~20
<b>HDMI Audio Input</b>	Select HDMI or PC audio input mode.
<b>DP Audio Input</b>	Select DisplayPort or PC audio input mode.
<b>Internal Speakers</b>	Disable or enable internal audio speakers.

## Basic Settings Menu

This menu is used to make initial setup adjustments to the OSD (On-Screen Display) menu and other on-screen messages.

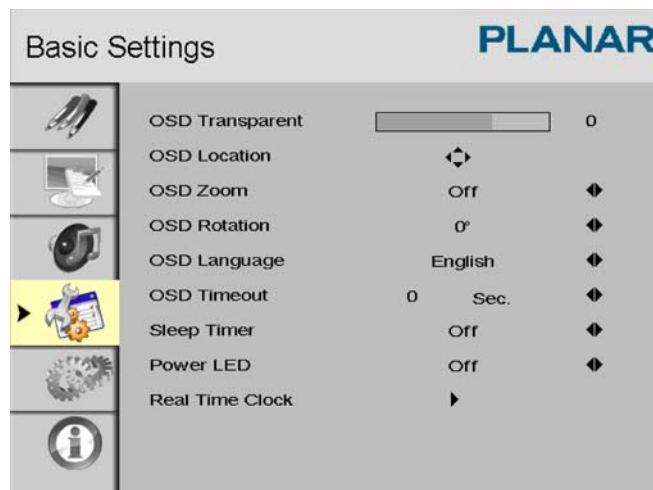

<b>OSD Transparent</b>	Set the menu transparency. Press ◀ or ▶ to select the desired level, and press ENTER. <b>Range:</b> 0~100
<b>OSD Location</b>	Adjust the menu location on the EP4650/EP5550 (Up, Down, Left, Right).
<b>OSD Zoom</b>	<b>Options:</b> On, Off

<b>OSD Rotation</b>	Select the OSD Rotation. Press ◀ or ▶ to select the rotation. <b>Options:</b> Landscape or Portrait
<b>OSD Language</b>	<b>Options:</b> English and Chinese
<b>OSD Timeout</b>	<b>Options:</b> 5~120
<b>Sleep Timer</b>	Set a period of time after which the EP4650/EP5550 will automatically switch to standby mode. Press ◀ or ▶ to select the desired time limit. <b>Options:</b> Off, increments of 15, 30, 45, 60, 90 or 120 minutes
<b>Power LED</b>	LED on rear of display shows powered on/off or standby mode. <b>Options:</b> On, Off
<b>Real Time Clock</b>	Set the date, and switch the alarm on and off. Use ▲, ▼, ◀, ▶ to adjust these options.

## Basic Menu/RTC (Real Time Clock) Menu

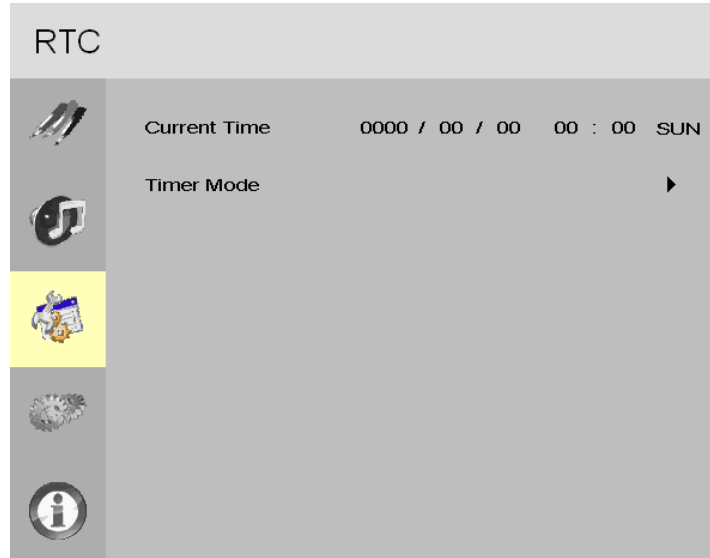

<b>Real Time</b>	Current time setting Year/Month/Date, Hour: Minutes
<b>Timer Mode</b>	Timer mode selection Power on and Power off timer setup

### RTC Timer Mode - User

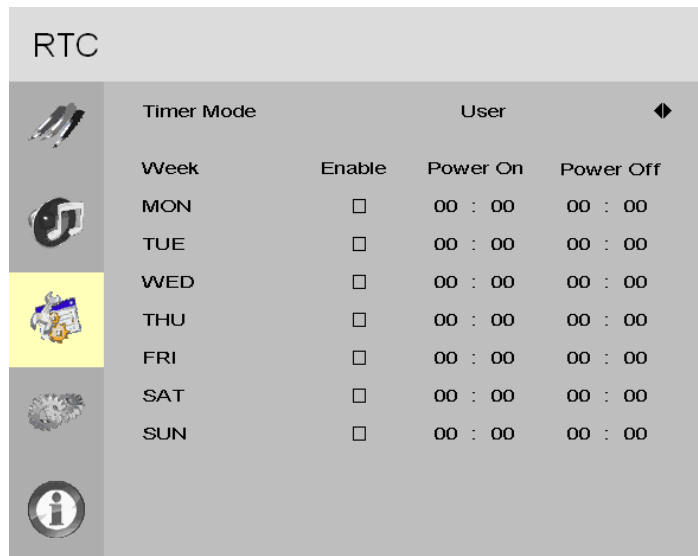

Timer Mode	
User mode	<p>Select the power on/off timer and specify the on/off times for each day of the week.</p> <p>For each day of the week, you have the following options:                      Enable or Disable the schedule of the day  <b>Options:</b> Disable, Enable</p> <p>Power On/Power Off timer setup.                      Power On: Use the arrow keys to specify the time you want the display to turn on for the selected day.                      Power Off: Use the arrow keys to specify the time you want the display to turn off for the selected day.</p>

## RTC Timer Mode - Work Days

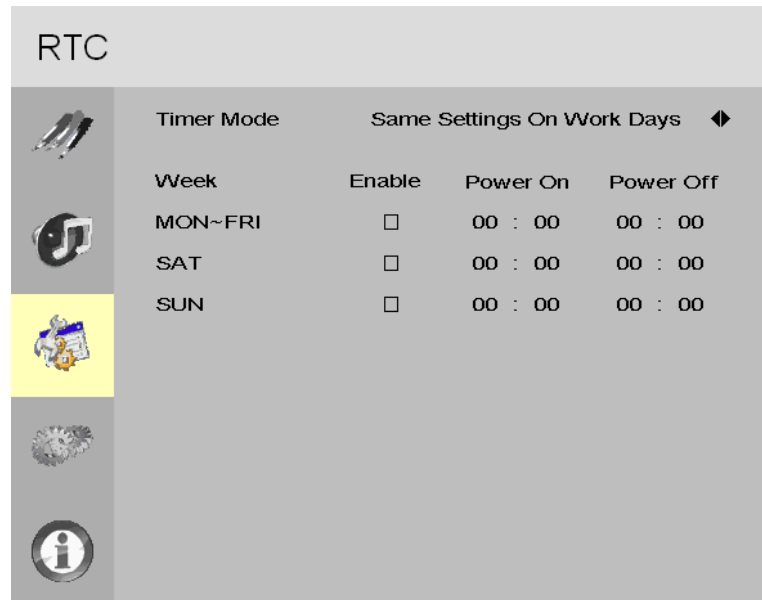

Timer Mode	
<b>Work Days</b> mode	<p>For Monday-Friday, Saturday or Sunday, you have the following options: Enable or Disable the schedule of the work days or individual weekend days. <b>Options:</b> Disable, Enable</p> <p>For all days, you have the following options: Enable or Disable the schedule for Monday-Friday, Saturday and Sunday. <b>Options:</b> Disable, Enable</p> <p>Power On/Power Off timer setup. Power On: Use the arrow keys to specify the time you want the display to turn on for Monday-Friday, Saturday or Sunday. Power Off: Use the arrow keys to specify the time you want the display to turn off for Monday-Friday, Saturday or Sunday.</p>

### RTC Timer Mode - All Days

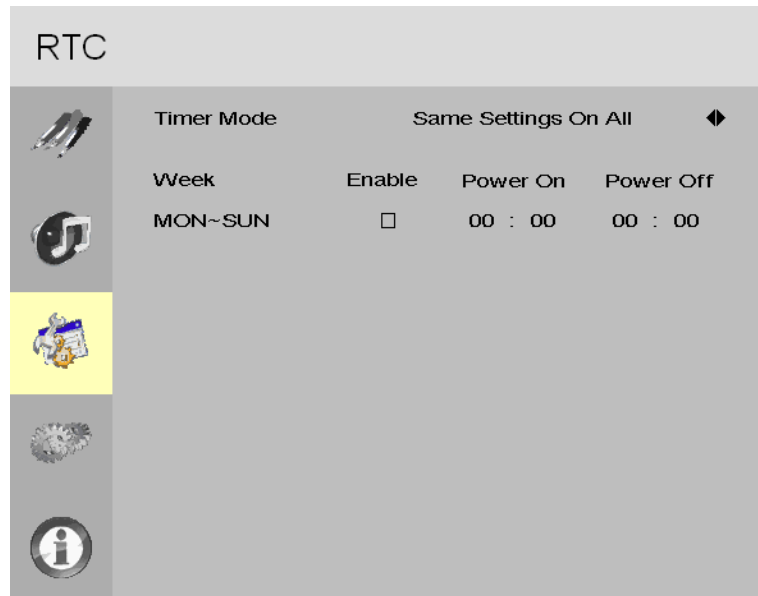

Timer Mode	
<b>All Days mode</b>	<p>Select all days of the week power on/off timer.</p> <p>For all days, you have the following options:                      Enable or Disable the schedule for all days of the week  <b>Options:</b> Disable, Enable</p> <p>Power On/Power Off timer setup.                      Power On: Use the arrow keys to specify the time you want the display to turn on for all days of the week.                      Power Off: Use the arrow keys to specify the time you want the display to turn off for all days of the week.</p>



## Advanced Settings Menu

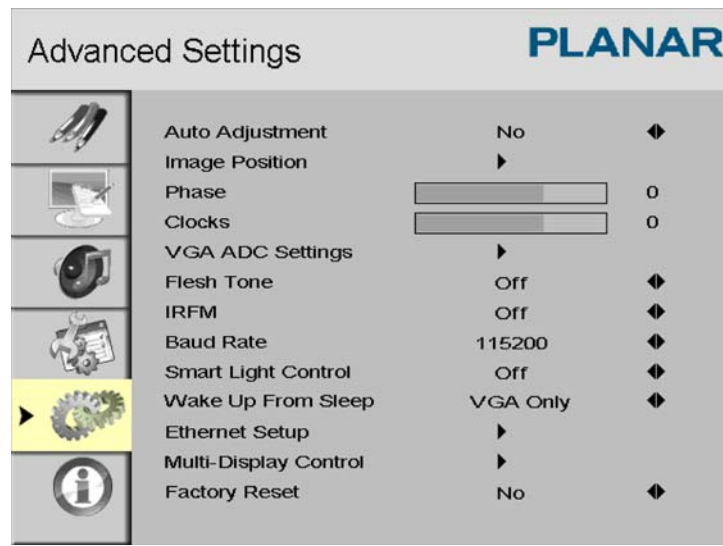

<b>Auto Adjustment</b>	<p>Forces the ep46L/ep55L to reacquire and lock to the input signal. This is useful when the signal quality is marginal.</p> <p><b>Note:</b> This feature does not continually reacquire the signal. It only does so each time you select this option.</p> <p><b>Options:</b> No, Yes</p>
<b>Image Position</b>	<p>Adjust the image location (VGA Mode only).</p> <p><b>Options:</b> Up, Down, Left, Right</p>
<b>Phase</b>	<p><b>Range:</b> 0~63 (VGA Mode only)</p>
<b>Clocks</b>	<p><b>Range:</b> 0~100 (VGA Mode only)</p>
<b>VGA ADC Settings</b>	<p>Select the ADC setting, User ADC Calibration, or restore factory default ADC setting.</p> <p><b>Options:</b> Default, User</p>

<b>Flesh Tone</b>	
	This feature is used to amplify all colors except that of people's faces. <b>Options:</b> Off, Low, Medium and High (Video Mode only)
<b>IRFM</b>	
	Creates slight frame motion to help avoid image retention. <b>Options:</b> On
<b>Baud Rate</b>	
	<b>Options:</b> 115200, 38400, 19200, 9600
<b>Smart Light Control</b>	
	<b>Options:</b> Off, DCR, Light Sensor
<b>Wake Up From Sleep</b>	
	Allows you to configure the display to "wake up" when it receives a digital signal through the DisplayPort, HDMI or DVI connectors. With VGA Only, the display can only "wake up" by sending an analog video signal through the VGA connector. <b>Options:</b> <i>Never Sleep</i> - The display will never enter a power saving mode. <i>VGA Only</i> - The display will enter a power saving mode if it cannot sync for five minutes with the DisplayPort, HDMI or DVI. If the sync is present, the display will "wake up" again. <i>VGA, Digital, RS232</i> - The display will enter a power saving mode if it cannot sync for five minutes with any source.
<b>Ethernet Setup</b>	
	Configure Network settings. See "Setting Up Email Alerts" on page 69 for more information.
<b>Multi-Display Control</b>	
	Used for displaying one image across multiple displays.
<b>Factory Reset</b>	
	Restores all settings to their defaults. <b>Options:</b> No, Yes

## Advanced Settings - Ethernet Setup Submenu

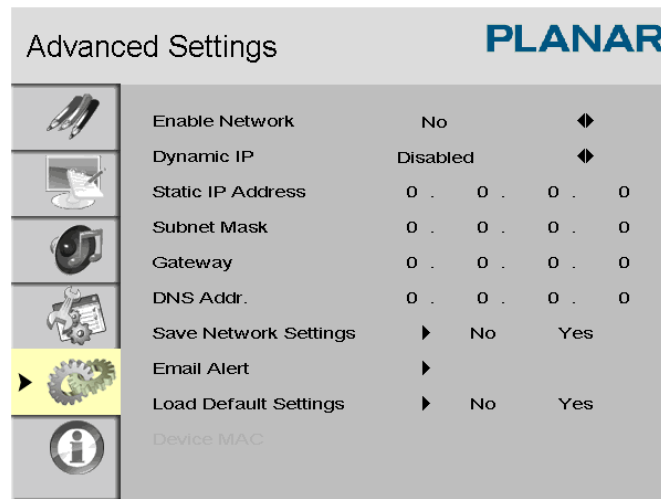

<b>Enable Network</b>	<p>Enable the network feature  <b>Options:</b> No, Yes</p>
<b>Dynamic IP</b>	<p>Enable DHCP for dynamic IP address assignment.  <b>Options:</b> Disable, Enable</p> <p><b>Note:</b> When dynamic IP is enabled, the parameters received from the DHCP server are shown in the STATIC IP ADDRESS, SUBNET MASK, GATEWAY and DNS ADD lines.</p>
<b>Static IP Address</b>	<p>Set the static IP address when the DYNAMIC IP line is disabled or view it when the DYNAMIC IP line is enabled.  <b>Range:</b> 255.255.255.255 (0.0.0.0)</p>
<b>Subnet Mask</b>	<p>Set the subnet mask when the DYNAMIC IP line is disabled or view it when the DYNAMIC IP line is enabled.  <b>Range:</b> 255.255.255.255 (0.0.0.0)</p>
<b>Gateway</b>	<p>Set the gateway address when the DYNAMIC IP line is disabled or view it when the DYNAMIC IP line is enabled.  <b>Range:</b> 255.255.255.255 (0.0.0.0)</p>

<b>DNS Address</b>	Set the DNS address when the DYNAMIC IP line is disabled or view it when the DYNAMIC IP line is enabled. <b>Range:</b> 255.255.255.255 (0.0.0.0)
<b>Save Network Settings</b>	Save the network configuration when the DYNAMIC IP line is disabled. <b>Options:</b> No, Yes
<b>Email Alert</b>	Enable/disable the following email alerts: POWER STATUS ALERT - Sent when the unit is turned on or off. SOURCE STATUS ALERT - Sent when a different source is selected. SIGNAL LOST ALERT - Sent when the input sync is lost.
<b>Load Default Settings</b>	Load default network settings <b>Options:</b> No, Yes
<b>Device MAC</b>	Shows the unique address assigned to network interfaces.

### User ADC Calibration

- 1 When using VGA as a signal source, go to ADVANCED SETTINGS in the OSD menu, select VGA ADC SETTINGS and then select USER ADC CALIBRATION.
- 2 A warning message (see image below) will appear to help you ensure that the correct image is displayed on screen before ADC calibration begins.
  - a The image in the green boxes, displayed on both side of the screen, has to be white and black in order to run the calibration accurately (the black and white image can be made using software like Microsoft Paint).
  - b The white in the left green box has to be the brightest white.

- c The black in the right box has to be the darkest black.

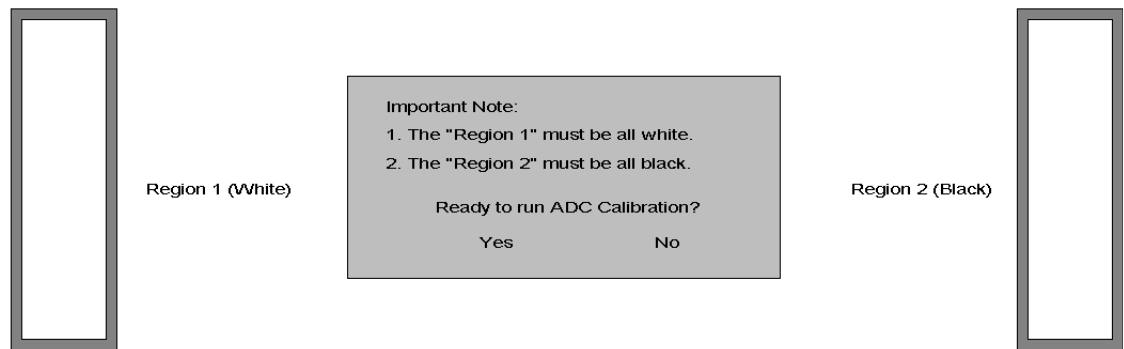

- 3 After the correct image is displayed, click "Yes" to begin ADC calibration.
- 4 During the calibration process, the following message will appear to notify you to wait for the calibration.

User ADC Calibration... Please Wait!

- 5 After the calibration is complete, you will see one of two messages.

User ADC Calibration Finish!

User ADC Calibration Failure!

### Advanced Settings - Multi-Display Control Submenu

The menu is used for displaying one image across multiple displays. The software allows you to tile up to a 5 x 5 array. With a DVI signal, you can loop up to nine displays. With a VGA signal, you can loop up to four displays. Therefore, it may be necessary to use a splitter to obtain the signal quality needed to drive a larger video wall.

It is also important to note that the maximum cable length between displays is three meters.

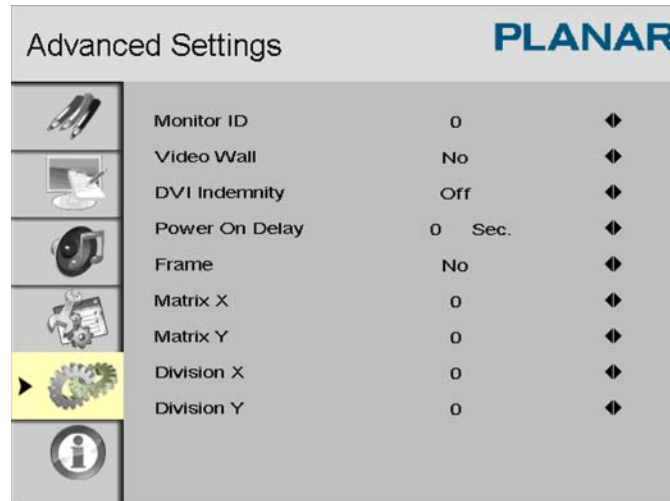

<b>Monitor ID</b>	<p>Used to manually set the Monitor ID of each display in the video wall.</p> <p><b>Options:</b> 1-25</p>
<b>Video Wall</b>	<p>Used for displaying one image across multiple displays.</p> <p><b>Options:</b> Yes, No</p> <p><b>Note:</b> If No is selected, all of the options below the Power On Delay line will be grayed out.</p>
<b>DVI Indemnity</b>	<p>Used for large Matrix walls that have a single digital source and DVI pass-thru cables. Turning DVI Indemnity may enhance the video quality and reliability of pass-thru signals.</p> <p><b>Options:</b> On, Off</p>
<b>Power On Delay</b>	<p>When powering on a video wall, this feature staggers the power on sequence so that all displays will not turn on at once, reducing current requirements.</p> <p><b>Options:</b> 0~1.50 (in .05 second increments)</p>
<b>Frame</b>	<p>This feature enables or disables frame compensation.</p> <p><b>Options:</b> Yes, No</p>

<b>Matrix X</b>	
	Sets the number of displays used in the horizontal position <b>Options:</b> 1-5
<b>Matrix Y</b>	
	Sets the number of displays used in the vertical position <b>Options:</b> 1-5
<b>Division X</b>	
	Sets the horizontal position of the display wall matrix <b>Options:</b> 1~ Matrix X
<b>Division Y</b>	
	Sets the vertical position of the display wall matrix <b>Options:</b> 1~ Matrix Y

## System Status Menu

This read-only menu provides information about the active sources and the latest firmware version.

**System Status** **PLANAR**

Channel Information		
	Source	Resolution
Main	VGA	1024x768@60.0Hz
PIP	HDMI1	1024x768@60.0Hz

Firmware Version : EP4650 - V0.10  
SUB MCU - V30

## Default Settings

The following table shows the default settings for the LCD.

<b>Item</b>	<b>Default</b>
Power switch	Off
Scheme	User
Brightness	50
Sharpness	12
Backlight	80
Contrast	50
Color temperature	9300K
Source auto detection	Off
OSD language	English
Smart light control	On
IRFM	Off
Baud rate	19200



# LAN Control

The EP4650/EP5550 supports extending access to the RS232 commands over a network connection using a virtual COM port (VCOM). The VCOM driver installer is included on the USB drive that came with your display.

## Supported Operating Systems

The utility supports the following operating systems:

- Windows 7 32-bit Edition
- Windows Vista 64-bit Edition
- Windows Vista 32-bit Edition
- Windows 2003 64-bit Edition
- Windows 2003 32-bit Edition
- Windows XP 64-bit Edition
- Windows XP 32-bit Edition
- Windows 2000

## Installation

Use the following instructions to install the VCOM driver.

- 1** Launch the vcomsetup.exe file.

- 2 You may see a security warning similar to the following example. Click Run to continue.

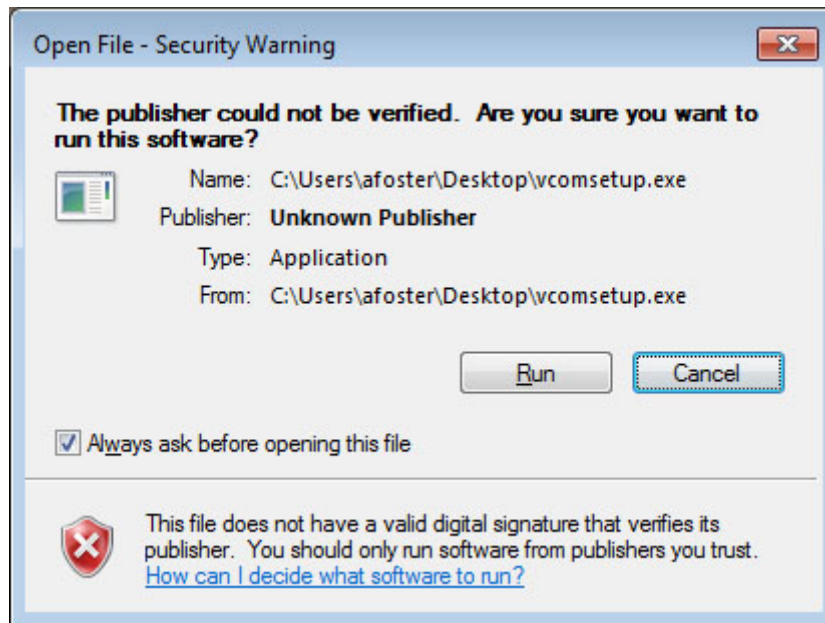

- The vcomsetup.exe installer installs both the VCOM virtual serial port and also a utility (WinPcap) for finding your EP4650/EP5550s on the network. Follow the steps in the two installers, accepting defaults and license agreements as needed.

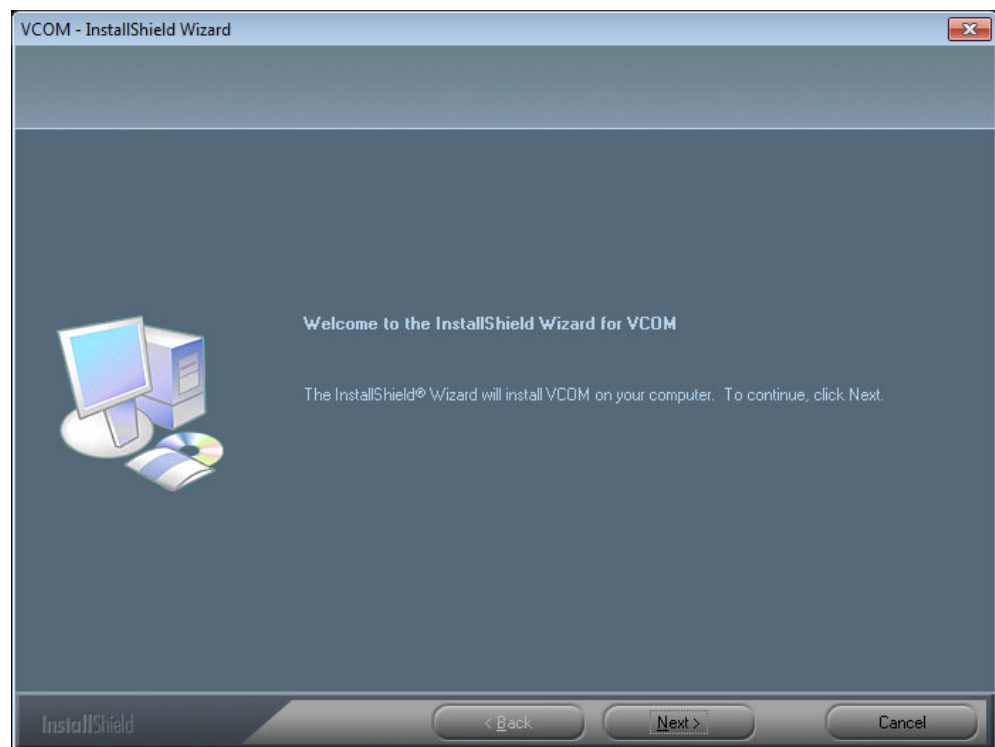
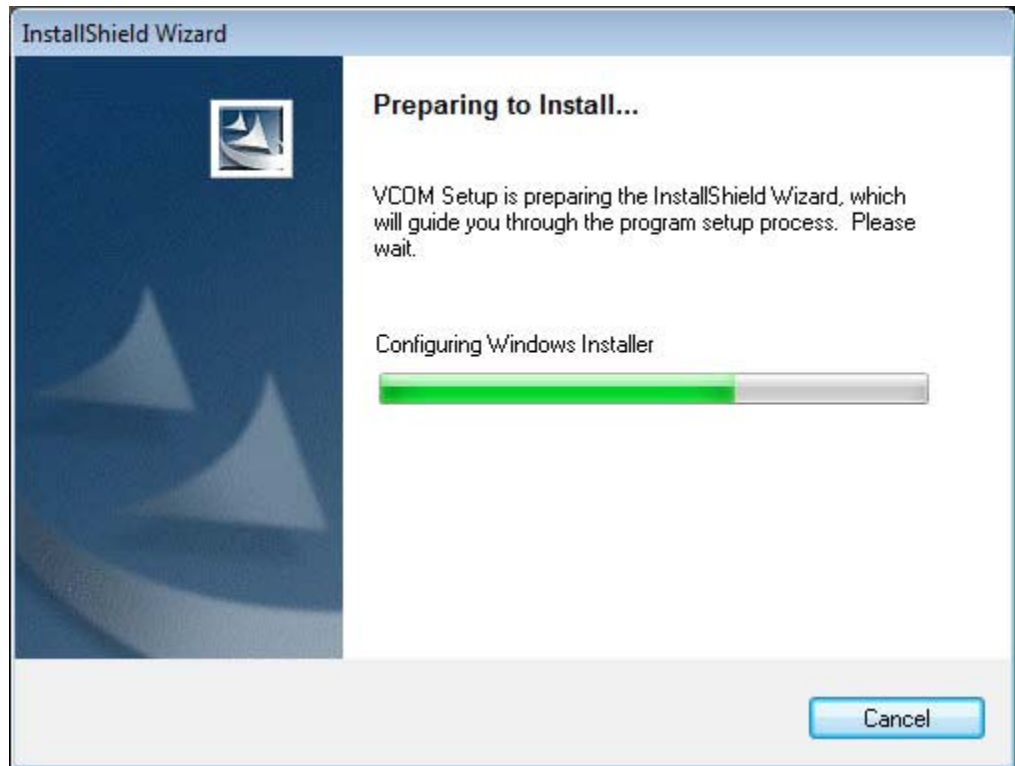

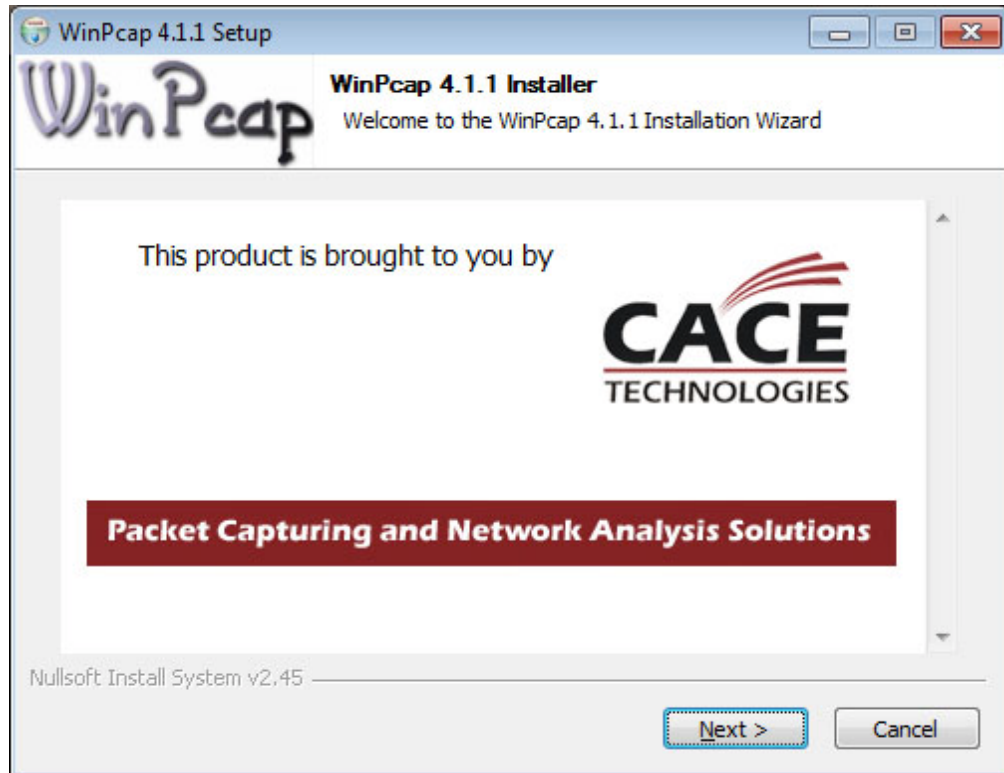

- 4 When the installers are finished, you will see a VCOM icon on your desktop and you find two new folders in your start menu: IC Plus corp (with VCOM sub folder) and WinPcap. If you need to uninstall the software, there are shortcuts to uninstall from these menus.



## Configuring VCOM

Use the VCOM shortcut to launch the VCOM setup utility. The utility starts up on the Device Info page, shown below. The controls on this page allow you to find and configure each EP4650/EP5550 that you want to access via virtual COM ports.

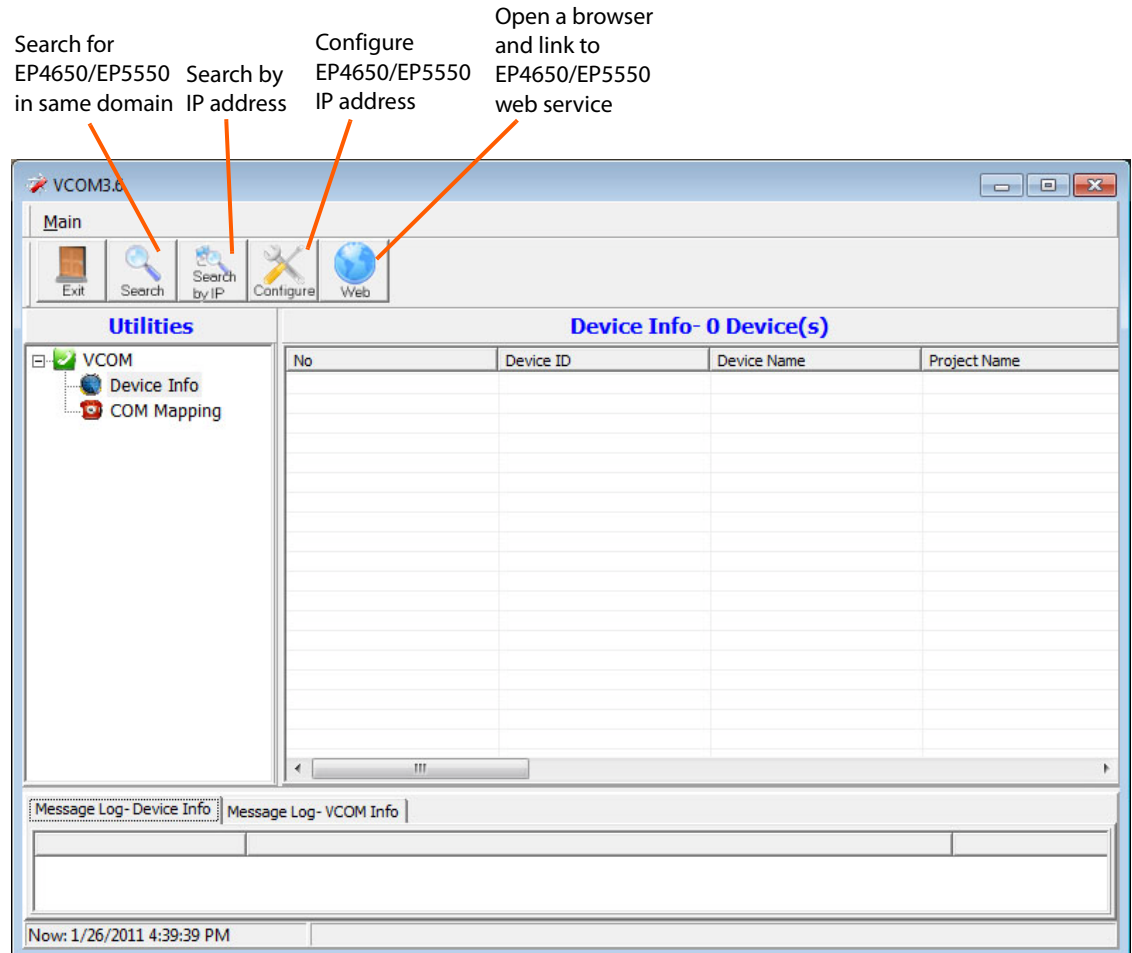

Click on COM Mapping to display the COM Mapping page, shown below. The controls on this page allow you to make virtual COM ports and select the EP4650/EP5550 to which you want to map each virtual COM port.

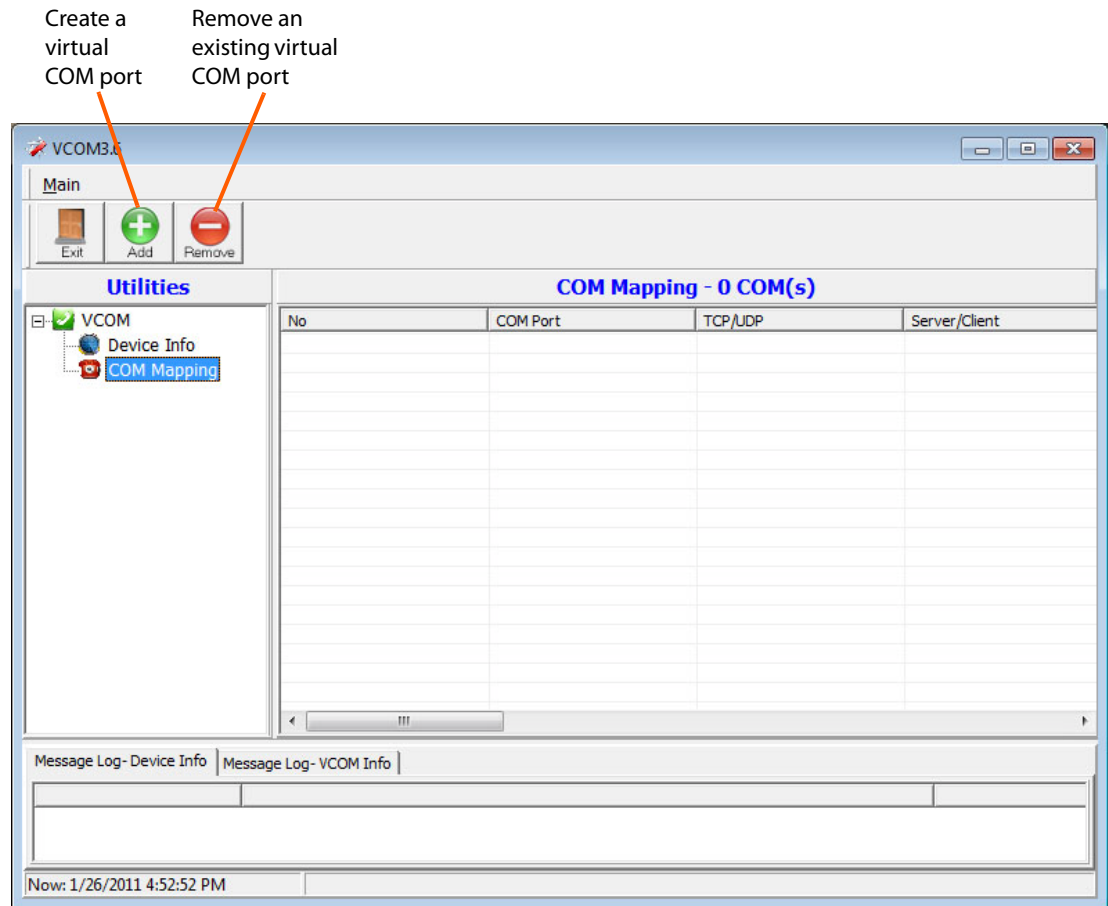

## Function Descriptions

### Search

In the Device Info page, click the Search icon. This function searches for any devices that are connected to the same network segment (maximum of 254 devices) as your PC. Any devices found will be listed in the Device Info table.

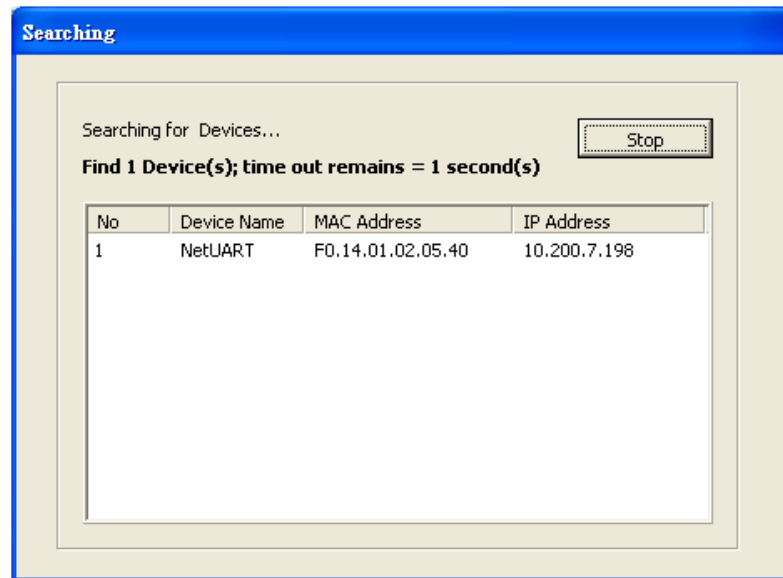

### Search By IP

On the Device Info page, click the Search by IP icon. This function searches for any devices in the given IP address range. Any devices found will be listed in the Device Info table.

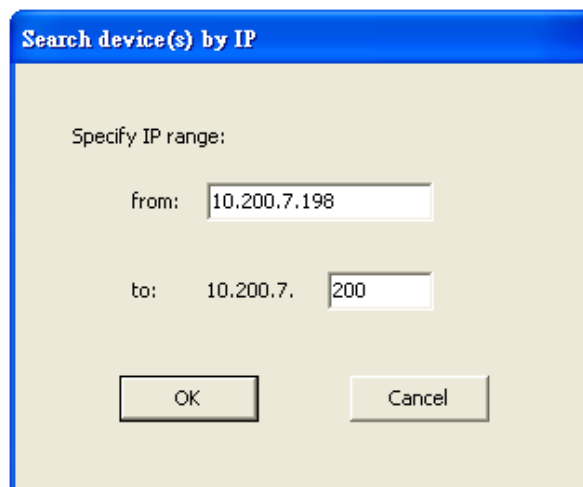

## Configure IP Address

This function allows you to configure the network settings of the selected EP4650/EP5550 device. We recommend using the on-screen menus or the web interface described in the User Guide instead of this function.

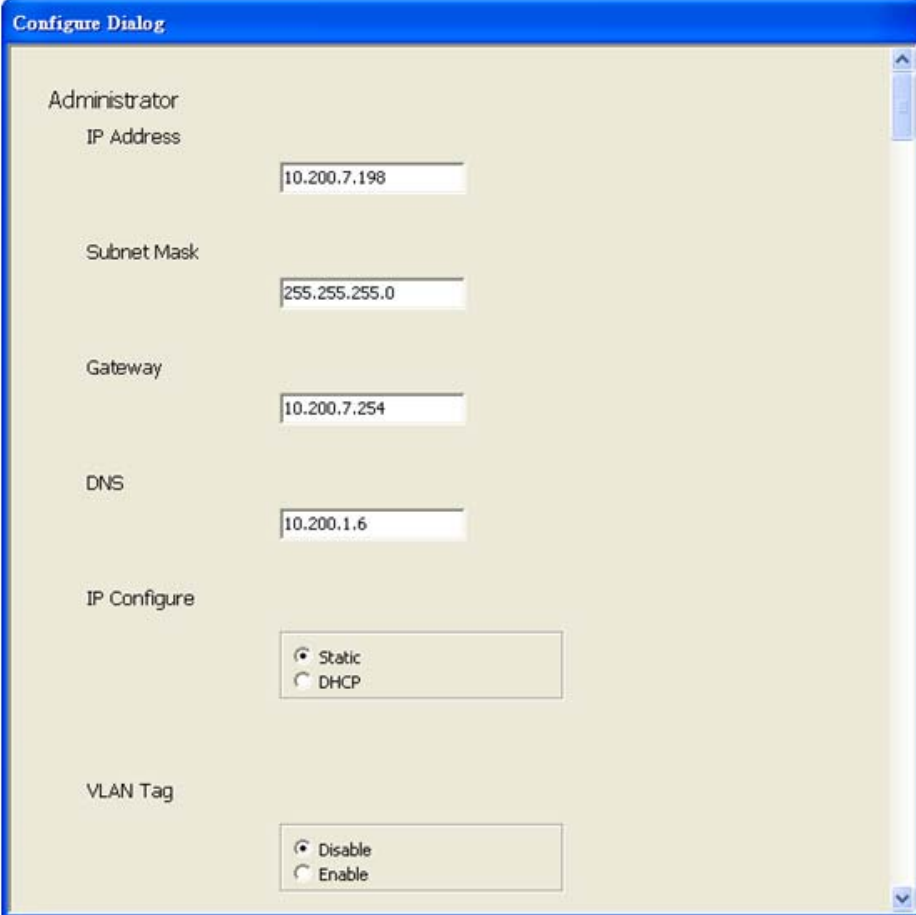

The screenshot shows a 'Configure Dialog' window with the following fields and options:

- Administrator**
- IP Address**: 10.200.7.198
- Subnet Mask**: 255.255.255.0
- Gateway**: 10.200.7.254
- DNS**: 10.200.1.6
- IP Configure**:
  - Static
  - DHCP
- VLAN Tag**:
  - Disable
  - Enable

**Note:** To cancel this function, scroll to the bottom and click the Cancel button.

## Web

Click the Web icon to launch your default browser and link it to the EP4650/EP5550 web service.



## Adding a Virtual COM Port

To add a virtual COM port, click the Add icon on the COM Mapping page to open the following dialog window.

The dialog window 'Add VCOM' contains the following elements:

- Rescan** button
- Table:**

No	Device Name	MAC Address	IP Address
1	NetUART	F0.14.01.02.05.40	10.200.7.198
- TCP/UDP:**  TCP,  UDP
- Server/Client:**  Server,  Client
- IP Address:** 10.200.7.198
- Local Port:** [Empty]
- COM:** COM 22
- Remote Port:** 23
- Enable Control Connection
- 1 second(s) for reconnection interval.
- OK** and **Cancel** buttons

Select the display you want to control from the table and accept defaults, as shown. Make a note of the COM number assigned to the new VCOM port. Click OK to create the new port. The new port appears in the COM Mapping table.

You can view details for the virtual COM port device using Device Manager, shown below.

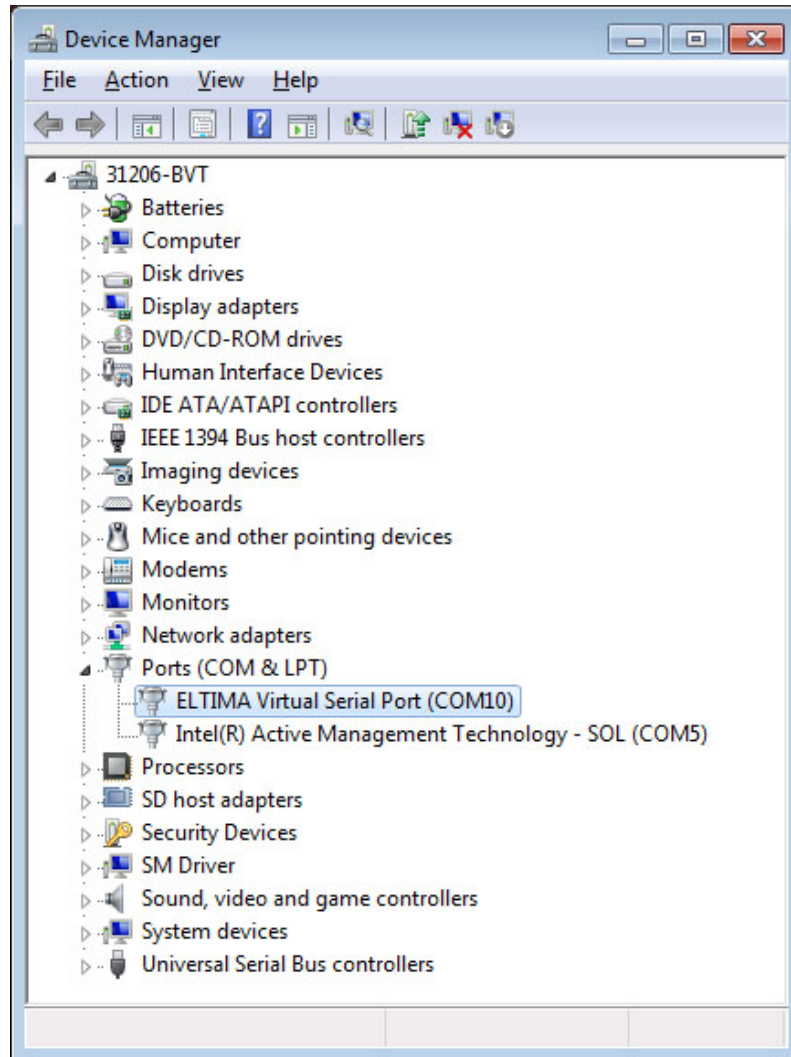

## Removing a COM Port

On the COM Mapping page, select the COM port you want to delete and click the REMOVE button.

# Setting Up Email Alerts

The web service allows you to configure the settings required to send email alerts. If you are not using email alerts, you do not need to use the web service and can skip this section.

## Login

When you direct your browser to the network IP address of the EP4650/EP5550, you are prompted to login as shown here.

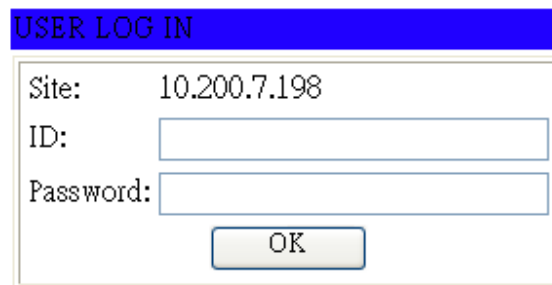

USER LOG IN

Site: 10.200.7.198

ID:

Password:

OK

The default ID is **admin** and the default password is **system**.

**Note:** Cookies and JavaScript must be enabled in your browser.

**Note:** If your session times out or if you enter an incorrect ID or password, you will see the following message.

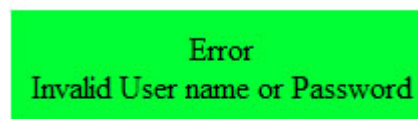

ok

When you first login, you will see the System Status page, as shown here.



**Administrator**  
[TCP Mode](#)  
[UDP Mode](#)  
[UART](#)  
[SMTP](#)  
[Reset Device](#)

### System Status

---

Kernel Version	V2018 (Dec 08 2010 10:08:13)
MAC Address	00:1F:B6:00:00:22
Nickname	<input type="text" value="NetUART"/> <input type="button" value="Update"/> Please refresh web page after press "updated" button.

Note:  
Comment name only can use "0-9","a-z","A-Z","\_","-"

## Administrator

Click on the word Administrator under the Planar logo to show/hide these menu items.

### Authentication Configuration

Set user ID and password for login to the web service.



When image experience matters.

**Administrator**

[Authentication Configuration](#)

[System IP Configuration](#)

[System Status](#)

[Load default setting](#)

[Firmware update](#)

[Boot Loader upgrade](#)

[TCP Mode](#)

[UDP Mode](#)

[UART](#)

[SMTP](#)

[Reset Device](#)

### Authentication Configuration

Setting	Value
Username	<input type="text" value="admin"/> max:15
Password Confirm	<input type="password" value="•••••"/> max:15 <input type="password" value="•••••"/>

Please refresh web page after press "updated" button.

Note:  
Comment name only can use "0-9", "a-z", "A-Z"

### System IP Configuration

You can view and/or change the network settings here. However, for best results, we recommend that you use the on-screen display menus, as described in "Advanced Settings - Ethernet Setup Submenu" on page 53.



When image experience matters.

**Administrator**

[Authentication Configuration](#)

[System IP Configuration](#)

[System Status](#)

[Load default setting](#)

[Firmware update](#)

[Boot Loader upgrade](#)

[TCP Mode](#)

[UDP Mode](#)

[UART](#)

[SMTP](#)

[Reset Device](#)

### System IP Configuration

Setting	Value
IP Address	<input type="text" value="192"/> . <input type="text" value="168"/> . <input type="text" value="2"/> . <input type="text" value="1"/>
Subnet Mask	<input type="text" value="255"/> . <input type="text" value="255"/> . <input type="text" value="255"/> . <input type="text" value="0"/>
Gateway	<input type="text" value="192"/> . <input type="text" value="168"/> . <input type="text" value="2"/> . <input type="text" value="1"/>
DNS	<input type="text" value="192"/> . <input type="text" value="168"/> . <input type="text" value="2"/> . <input type="text" value="1"/>
IP Configure	<input type="radio"/> Static <input checked="" type="radio"/> DHCP
VLAN Tag	<input checked="" type="radio"/> Disable <input type="radio"/> Enable : VLAN ID <input type="text" value="0"/>

Please refresh web page after press "updated" button.

If your network requires a VLAN tag, your network administrator will give you a number from 1 to 4094 to enter here.

## System Status

- Kernel version - Shows the firmware version for the network interface.
- MAC Address - Shows the unique address assigned to the network interface.
- Nickname - Enter a device tag, up to 12 characters. This tag will appear in email alerts, which help you identify the source of the alert.

**PLANAR**  
When image experience matters.

**Administrator**

- [Authentication Configuration](#)
- [System IP Configuration](#)
- [System Status](#)**
- [Load default setting](#)
- [Firmware update](#)
- [Boot Loader upgrade](#)
- TCP Mode**
- UDP Mode**
- UART**
- SMTP**
- Reset Device**

### System Status

Kernel Version	V2018 (Dec 08 2010 10:08:13)	
MAC Address	00:1F:B6:00:00:22	
Nickname	<input type="text" value="NetUART"/>	<input type="button" value="Update"/>
Please refresh web page after press "updated" button.		

Note:  
Comment name only can use "0-9","a-z","A-Z","\_","-"

## Load Default Setting

- 1 Click the LOAD button to return the network interface to default settings.

Load Default Setting to EEPROM

- 2 After a few seconds, you will see a green box with the message "Setting Saved RESET." Click the RESET button to restart the network interface.

Setting Saved  
RESET

- 3 Make sure the IP address in your browser is correct and then click OK.

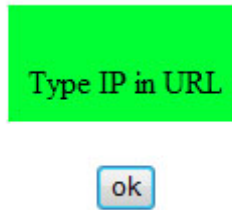

- 4 When the process is complete, you should see the login page again.

## Firmware Update and Boot Loader Upgrade

In most cases, you will not need to update firmware for the network interface. If you do, contact Planar's Technical Support Department. See "Accessing Planar's Technical Support Website" on page 81 for more information.

**WARNING!** Do not use the controls in these two sections unless you have received a specific procedure and firmware from Planar. Following improper procedures can disable the network interface and require factory repair service.

## TCP Mode, UDP Mode and UART

For normal operation, you will not need to change any settings on these pages. If you do need to change information, Planar's Technical Support Department will provide you with more information.

## SMTP

### SMTP setup

Enable SMTP	<input type="checkbox"/> Enable, Port: 25
SMTP server address	smtp.xxx.yyy
SMTP Login Information	<input type="checkbox"/> Enable Username: username, Password: ●●●●●●
Mail to	xxx@yyy.zzz max: 200
Mail from	xxx@yyy.zzz



Your network administrator must provide information for the following fields:

- Enable SMTP - Make sure this checkbox is checked. Port 25 is the default.
- SMTP Server Address - Name or IP address of the mail server.
- SMTP Login Information - If required, check the ENABLE box and enter a username and password.
- Mail to - Enter the destination email addresses. Separate multiple addresses with a semi-colon.
- Mail from - Enter the email address from which you want to send alerts.

SMTP 01 Warning	
Subject	Power Status Change Alert
Message Body	SMTP 01 body max: 100

SMTP 02 Warning	
Subject	Source Change Alert
Message Body	SMTP 02 body max: 100

SMTP 03 Warning	
Subject	Signal Lost Alert
Message Body	SMTP 03 body max: 100

You can edit the subject and body of the email warnings, which are sent when there is a power status change, source change and signal lost. The SMTP 04 and 05 warnings are not used.

## Reset Device

Click the RESET button to reboot the network interface. Note that the current settings are not changed.

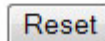

# Signal Compatibility

Timing		fH (KHz)	fV (Hz)	Dot clock (MHz)	HDMI	VGA	Component	S-Video	Video	DVI	Display Port	HD-SDI*	
VESA	VGA 640 x 480	31.469	59.94	25.175	0	0	-	-	-	0	0	-	
		37.861	72.809	31.5	0	0	-	-	-	0	0	-	
		37.5	75	31.5	0	0	-	-	-	0	0	-	
		43.269	85.008	36	0	0	-	-	-	0	0	-	
	SVGA 800 x 600	35.156	56.25	36	0	0	-	-	-	0	0	-	
		37.879	60.317	40	0	0	-	-	-	0	0	-	
		48.077	72.188	50	0	0	-	-	-	0	0	-	
		46.875	75	49.5	0	0	-	-	-	0	0	-	
		53.674	85.06	56.25	0	0	-	-	-	0	0	-	
		XGA 1024 x 768	48.363	60.004	65	0	0	-	-	-	0	0	-
			56.476	70.069	75	0	0	-	-	-	0	0	-
			60.023	75.029	78.75	0	0	-	-	-	0	0	-
68.677	84.997		94.5	0	0	-	-	-	0	0	-		
	WXGA1366 x 768	47.72	59.799	84.75	0	0	-	-	-	0	0	-	
		1280 x 720	44.444	59.98	64	0	0	-	-	-	0	0	-
			44.772	59.86	74.5	0	0	-	-	-	0	0	-
			56.456	74.78	95.75	0	0	-	-	-	0	0	-
1280 x 768	47.776		59.87	79.5	0	0	-	-	-	0	0	-	
	47.396	59.995	68.25	0	0	-	-	-	0	0	-		
	68.633	84.837	117.5	0	0	-	-	-	0	0	-		
	1280 x 800	49.306	59.91	71	0	0	-	-	-	0	0	-	
49.702		59.81	83	0	0	-	-	-	0	0	-		
SXGA		1152 x 864	67.5	75	108	0	-	-	-	-	0	-	
		1280 x 1024	63.981	60.02	108	0	0	-	-	-	0	-	
		79.976	75.025	135	0	0	-	-	-	0	-		

Timing			fH (KHz)	fV (Hz)	Dot clock (MHz)	HDMI	VGA	Component	S-Video	Video	DVI	Display Port	HD-SDI*
			91.146	85.024	157.5	0	0	-	-	-	0	0	-
	SXGA+	1400 x 1050	64.744	59.95	101	0	-	-	-	-	-	0	-
			65.317	59.98	121.75	0	-	-	-	-	-	0	-
	1440 x 900		55.469	59.901	88.75	0	0	-	-	-	0	0	-
			55.935	59.88	106.5	0	0	-	-	-	0	0	-
	WSXGA+ 1680 x 1050		64.674	59.883	119	0	0	-	-	-	0	0	-
			65.29	59.954	146.25	0	0	-	-	-	0	0	-
	UXGA 1600 x 1200		75	60	162	0	0	-	-	-	0	0	-
	1920 x 1080		66.587	59.93	138.5	0	0	-	-	-	0	0	-
	WUXA 1920 x 1200		74.038	59.95	154	0	0	-	-	-	0	0	-
SDTV	NTSC		15.734	29.97	13.5	-	-	480i	0	0	-	-	487i
	PAL		15.625	25	13.5	-	-	576i	0	0	-	-	576i
EDTV	480p		31.5	60	27.03	0	-	0	-	-	0	0	-
	576p		31.25	50	27	0	-	0	-	-	0	0	-
HDTV	720p		37.5	50	74.25	0	-	0	-	-	0	0	0
	1280 x 720		44.995	59.94	74.176	0	-	0	-	-	0	0	0
			45	60	74.25	0	-	0	-	-	0	0	0
	1080i		28.13	50	74.25	0	-	0	-	-	0	0	0
	1920 x 1080		33.716	59.94	74.176	0	-	0	-	-	0	0	0
			33.75	60	74.25	0	-	0	-	-	0	0	0
	1080p 1920 x 1080		27	24	74.25	0	-	-	-	-	-	0	0
			28.125	25	74.25	-	-	-	-	-	-	-	0
			33.716	29	74.18	-	-	-	-	-	-	-	0
			33.75	30	74.25	-	-	-	-	-	-	-	0
			56.25	50	148.5	0	-	0	-	-	0	0	-
			67.433	59.94	148.352	0	-	0	-	-	0	0	-
			67.5	60	148.5	0	-	0	-	-	0	0	-

**Note:** 480i means supported 480i @ 60 Hz (YPbPr). 576i means supported 576i @ 50 Hz (YPbPr)

\* HD-SDI is an optional feature.

# Specifications

Item		Specification
LCD panel	Resolution	1920 x 1080
	Brightness (typ.) EP4650 EP5550	700 cd/m <sup>2</sup> 700 cd/m <sup>2</sup>
	Contrast Ratio	Minimum 3000:1, Typical 4000:1
	Response Time EP4650 EP5550	5.5 ms 5.5 ms
	Aspect Ratio	16:9
	Horizontal Sync.	Positive/Negative
	Vertical Sync.	Positive/Negative
	Connectors	Display port/HDMI x 2 / SDI x 2 / VGA / DVI / PC Audio in / IR Extender / Line Out / Component (w/ audio) / S-Video / Video-composite (w/ audio)
Performance	Auto Adjust	Clock, Phase, H-Position and V-Position
	Screen Scaling	VGA/SVGA/XGA/WXGA/HD Full Screen Display
	Frame Delay  Graphics mode Interlaced video mode Progressive video mode	1 frame 3 frames 2 frames  <b>Note:</b> For HD-SDI/VW, add 200-300 microseconds
	Framelock	50-60 Hz
	Power Management	VESA DPMS, DVI DMPM
	OSD Language	English and Chinese
Power Source	Input Voltage/Frequency	AC 100V~240V, 50-60 Hz
Power Consumption	Operation Mode (Max) EP4650 EP5550	135W (BTU calculation: 135W x 3.42 = 461.7 BTU/hr) 155W (BTU calculation: 155W x 3.42 = 530.1 BTU/hr)
	Power Saving Mode (Max)	.5W

Item		Specification
Physical	Standard Dimensions (W x H x D)	
	EP4650	41.6" (W) x 24.1" (H) x 2.0" (D) 1057.1mm (W) x 611.9mm (H) x 51.0mm (D)
	EP5550	49.2" (W) x 28.3" (H) x 2.1" (D) 1248.6mm (W) x 719.4mm (H) x 52.2mm (D)
		<b>Note:</b> For HD-SDI/VW models, add 0.9" (22mm) depth
	Net Weight	
	EP4650	50.3lbs (22.8kg)
	EP5550	66.6lbs (30.2kg)
	Gross Weight w/ packing	
	EP4650	61.3lbs (27.8kg)
	EP5550	82.0lbs (37.2kg)
Environment	Storage Temperature	Min -4°F ~ Max 140° F (-20°C ~ Max 60°C)
	Operating Temperature	Min 41°F ~ 104°F (5°C ~ Max 40°C)
	Humidity	80% RH @ 104°F (40°C)
Function	Plug and Play	DDC 2B Compliance
	RS232	D-Sub 9-pin / RJ45 in & out
	OSD key	7 keys (⏻, SOURCE, ▲, ▼, ◀, ▶, MENU/EXIT)
	Wall mount	400 x 400, 400x 200 VESA standards

# Troubleshooting

Before calling service personnel, please check the following table for a possible cause of the problem you are experiencing. Please note the following:

- Perform the adjustments according to "Operating the EP4560/EP5550" on page 19.
- If the problem you have experienced isn't described below or you can't correct the problem, stop using the EP4650/EP5550 and contact Planar's Technical Support Department. (See "Accessing Planar's Technical Support Website" on page 81)

Issue	Check for the following
No image is displayed	Make sure the correct source is selected.
	Make sure the main power switch is turned ON.
	Check that the source equipment is operating correctly.
	Make sure the input signal is compatible with this display.
The image is not centered	Make sure the input signal is compatible with this display.
The remote control doesn't work	Make sure the batteries are new and are installed correctly. Ensure the remote is aimed at the IR sensor.
	Make sure the remote control sensor is plugged in correctly.
	Make sure the remote is aimed towards the back of the display, where the sensor is located.
The picture color looks poor	Check the picture settings. Reset the display.
	If you are using YUV terminals, make sure cables are correctly connected.
	Check ADC calibration. (See "User ADC Calibration" on page 54)

# Accessing Planar's Technical Support Website

- 1 Go to <http://planarpartners.com>
- 2 Once you enter your login and password, you can access downloadable utility software, new firmware and user manuals.

## Downloading Additional Documentation and Firmware

Some of the other documents for the EP4650/EP5550, which are or will be available on [www.planar.com](http://www.planar.com), are listed below:

Document Name	Contents
User Guide	Information for installers and end users to install and use displays.
RS232 Codes User Manual	Technical information about the product, such as display mode information and how to use RS232 commands to control displays.

## Downloading Utility Software

- 1** Go to <http://planarpartners.com>.
- 2** Enter your login and password information.
- 3** Under the Service heading on the left pane, select the Software/Firmware subheading. Then select the LCD Displays tab and scroll until you find updates related to the ep series.
- 4** From the list of available software, click on the tool you need.



# Index

---

## A

accessory kit, 10  
adjusting volume, 26  
administrator in web service, 71  
advanced settings menu, 39, 51  
audio settings menu, 37, 44  
authentication configuration page, 71  
avoiding temporary image retention, 4

---

## B

basic settings menu, 37, 45  
batteries  
    changing in the remote, 25

---

## C

cleaning the display, 7  
cooling requirements, 6

---

## D

default display settings, 58  
default setting  
    loading in web service, 72  
dimensions, 11  
display settings menu, 36, 43

---

## E

exemptions for product use, 8

---

## H

HD-SDI board  
    installing, 19

---

## I

image settings menu, 36, 41  
input source  
    selecting, 27  
inputs  
    for PIP mode, 30  
installation, 17  
    HD-SDI board, 19  
    safety precautions, 3  
introduction, 1  
ip system configuration, 71

---

## L

locking, 24

---

## M

menus  
    advanced settings, 51  
    audio settings, 44  
    basic settings, 45  
    display settings, 43  
    image settings menu, 41  
    system, 57  
    using, 40

---

## N

navigating, 40  
navigating menus, 40  
network interface  
    resetting, 75  
network settings menu, 39  
normal usage guidelines, 6

---

## O

operating the displays, 19  
osd menus, 24, 36, 40

- advanced settings, 39
- audio settings, 37
- basic settings, 37
- display settings, 36
- functions, 31
- image settings, 36
- network settings, 39
- RTC, 38
- system status, 38
- unlocking, 24

---

## P

- package contents, 8
- PIP mode, 28
  - available inputs, 30
- power
  - cord, 18
  - input, 18
- product usage
  - exemptions, 8

---

## R

- recommended usage, 4
- remote control
  - changing the batteries, 25
  - using, 22
- resetting the network interface, 75
- RTC menus, 38

---

## S

- safety
  - during installation, 3
  - information, 2
  - precautions, 2
  - precautions during use, 4
- selecting input source, 27
- service plans, ii
- settings
  - default, 58
- signal compatibility, 76
- signal source input, 18
- SMTP setup page, 74
- specifications, 78
- supported timings, 76
- system ip configuration page, 71

- system status menu, 38, 57
- system status page, 70, 72

---

## T

- temporary image retention
  - avoiding, 4
  - definition, 4
- timings, 76
- TIR *see temporary image retention*
- troubleshooting, 80
- turning off the displays, 26
- turning on the displays, 25

---

## U

- unpacking the displays, 8
- using the remote, 22

---

## V

- vesa mounts, 6
- volume, 26

---

## W

- warranty
  - exemptions, 8
  - information, ii
- web service, 69
  - administrator, 71
  - authentication configuration, 71
  - loading default setting, 72
  - reset device, 75
  - SMTP setup page, 74
  - system ip configuration, 71
  - system status, 70
  - system status page, 72