



LA1950RTR / LA1950RTC

LA1950RTS / LA1950R

Touch Screen LCD Monitor

USER'S GUIDE

www.planartouch.com

The information contained in this document is subject to change without notice.

This document contains proprietary information that is protected by copyright. All rights are reserved. No part of this document may be reproduced, translated to another language or stored in a retrieval system, or transmitted by any means, electronic, mechanical, photocopying, recording, or otherwise, without prior written permission. Windows is a registered trademark of Microsoft, Inc. Other brand or product names are trademarks of their respective holders.

The test results show that this device meets the FCC rules. Those limits are set to protect residential areas from the devices with harmful emission. This device will produce, use and radiate radio frequency energy. In addition, failure to follow the user's manual to install or use this device might produce harmful interference with radio communication. Notwithstanding the foregoing, it does not guarantee that this type of harmful interference does not occur in some special installations. The interference caused by this device to the reception of radio or television signals may be verified by turning it on and off. Any changes or modifications to this TFT LCD would void the user's authority to operate this device.

Important Recycle Instruction:

 Lamp(s) inside this product contains mercury. This product may contain other electronic waste that can be hazardous if not disposed of properly. Recycle or dispose in accordance with local, state, or federal Laws. For more information, contact the Electronic Industries Alliance at WWW.EIAE.ORG. For lamp specific disposal information check WWW.LAMPRECYCLE.ORG.

Table of Contents

Usage Notice

Precautions.....	1
------------------	---

Introduction

About LA1950 Series.....	2
Touch Screen for LA1950RTR.....	2
Touch Screen for LA1950RTC.....	2
Touch Screen for LA1950RTS.....	3
Non-Touch Screen for LA1950R.....	3
Package Overview	4

Installation

Product Overview	5
Front View	5
LA1950RTR / LA1950RTC / LA1950RTS Bottom View	5
LA1950R Bottom View	5
Attaching the L-Brackets.....	6
Side Mount for Your Monitor	7
Connecting the Display (Figure 10.1).....	9
(Figure 10.1).....	10

User Controls

Back Panel Controls	11
How to Use the OSD Menus	12
On-Screen Display Menus	13

Appendix

Troubleshooting.....	14
Warning Signal	15
No Signal.....	15
Going to Sleep.....	15
Out of Range	15
Product Dimensions	16
Compatibility Modes	17
Touch Screen Driver Installation	18
LA1950RTR / LA1950RTC / LA1950RTS Optional Calibration Tool Install:.....	18
LA1950RTR / LA1950RTC / LA1950RTS Install Instructions:.....	19
Product Registration and Technical Support	21

Usage Notice



Warning - To prevent the risk of fire or shock hazards, do not expose this product to rain or moisture.



Warning - Please do not open or disassemble the product as this may cause electric shock.

Precautions

Follow all warnings, precautions and maintenance as recommended in this user's manual to maximize the life of your unit.

Do:

- Turn off the product before cleaning.
- Touch screen surface may be cleaned using a soft clean cloth moistened with mild window glass commercial cleaners or 50/50 mixture of water and isopropyl alcohol.
- Use a soft cloth moistened with mild detergent to clean the display housing.
- Use only high quality and safety approved AC/DC adapter.
- Disconnect the power plug from AC outlet if the product is not going to be used for an extended period of time.

Don't:

- Do not touch the LCD Display screen surface with sharp or hard objects.
- Do not use abrasive cleaners, waxes or solvents for your cleaning.
- Do not operate the product under the following conditions:
 - Extremely hot, cold or humid environment.
 - Areas susceptible to excessive dust and dirt.
 - Near any appliance generating a strong magnetic field.
 - In direct sunlight.

Introduction

About LA1950 Series

The LA1950 Series is a 19" flat panel screen with an active matrix, thin-film transistor (TFT) liquid crystal display (LCD).

Features include:

- Direct Analog signal input
- Active matrix TFT LCD technology
- 1280x1024 SXGA resolution
- 19" viewable display area
- 31.47 ~ 80 kHz horizontal scan
- 56 ~ 75 Hz high refresh rate
- 0.294mm x 0.294mm Pixel pitch
- Auto adjustment function
- Multilingual OSD user controls
- 75 mm/100 mm VESA mount
- Bracket mount
- LA1950RTR - 5-wire resistive touch screen with dual RS-232 Serial/USB controller
- LA1950RTC - Capacitive touch screen with dual RS-232 Serial/USB controller
- LA1950RTS - SAW touch screen with dual RS-232 Serial/USB controller
- LA1950R - Pure Glass Non-Touch screen

Touch Screen for LA1950RTR

- 5-wire resistive touch screen for finger and stylus input
- Surface: Anti-glare treatment
- Interface: Dual RS-232 Serial/USB controller
- Transmittance: 82±5%
- Driver: Windows® 7, VISTA, XP, 2000, ME, 98, NT4.0, CE, XP Embedded, Linux, Apple® Mac OS

Touch Screen for LA1950RTC

- Capacitive touch screen for finger input only
- Surface: Anti-glare treatment
- Interface: Dual RS-232 Serial/USB controller
- Transmittance: 85±5%
- Driver: Windows® 7, VISTA, XP, 2000, ME, 98, NT4.0, CE, XP Embedded, Linux, Apple® Mac OS

Touch Screen for LA1950RTS

- Surface Acoustic Wave (SAW) touch screen for finger and stylus input
- Surface: Anti-glare treatment
- Interface: Dual RS-232 Serial/USB controller
- Transmittance: $92\pm 5\%$
- Driver: Windows® 7, VISTA, XP, 2000, ME, 98, NT4.0, CE, XP Embedded, Linux, Apple® Mac OS

Non-Touch Screen for LA1950R

- Pure Glass
- Surface: Anti-glare treatment
- Interface: N/A
- Transmittance: $91.5\pm 5\%$
- Driver: N/A

Package Overview



LCD Display

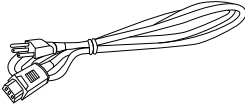

Power Cord

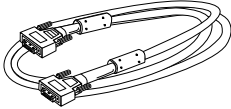

VGA Signal Cable

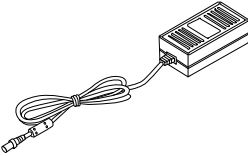

DC Power Supply

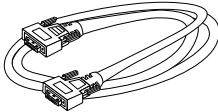

RS-232 Cable
(LA1950RTR/RTC/RTS only)

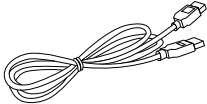

USB Cable (A to B)
(LA1950RTR/RTC/RTS only)

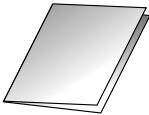

Quick Start Guide

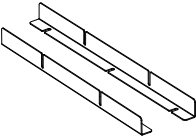

Bracket



Screw

Product Overview

- **Front View**

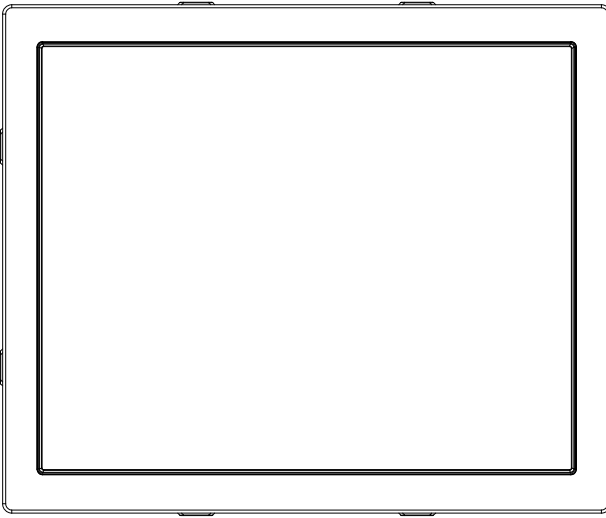

- **LA1950RTR / LA1950RTC / LA1950RTS Bottom View**

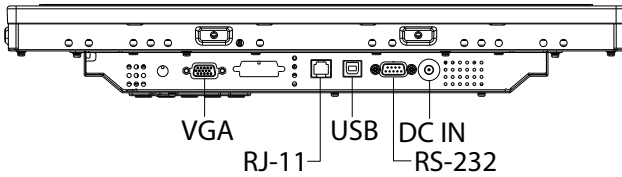

- **LA1950R Bottom View**

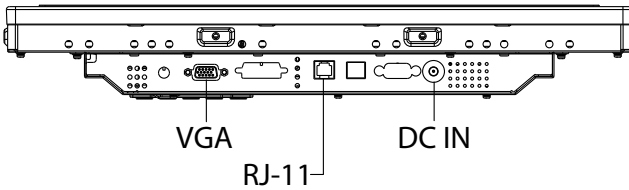

Attaching the L-Brackets

Depending on your mounting scheme, alternately, you may use the L-brackets to mount your displays onto your wall or device.

Find a suitable location for attaching L-brackets.

- A. The left and right sides
- B. The Top and bottom sides

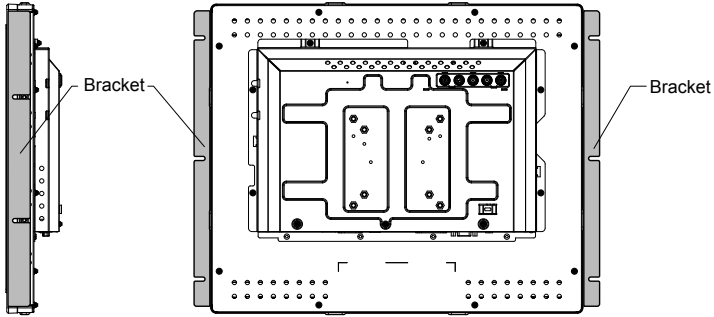

OR

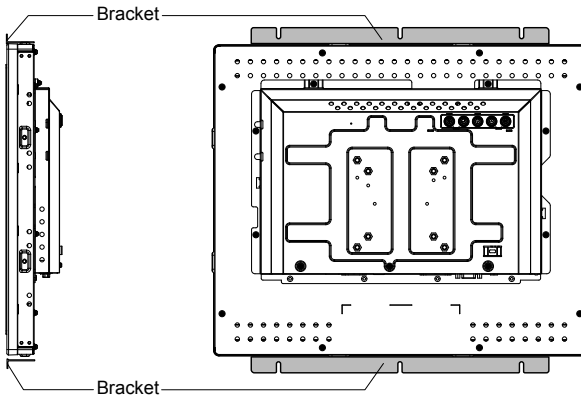

Note:

You will need a screwdriver to attach the L-brackets.

Your kiosk touch monitor included two L-brackets (and four screws, M4x6).

This equipment is intended to be mounted in accordance with the proper hardware and the installation instructions supplied with the product. Use of mounting brackets or screws other than those specified in the installation instructions may cause a hazard.

Side Mount For Your Monitor

This monitor can be mounted to the wooden or concrete wall with 4 screws and a pair brackets on the opposites.

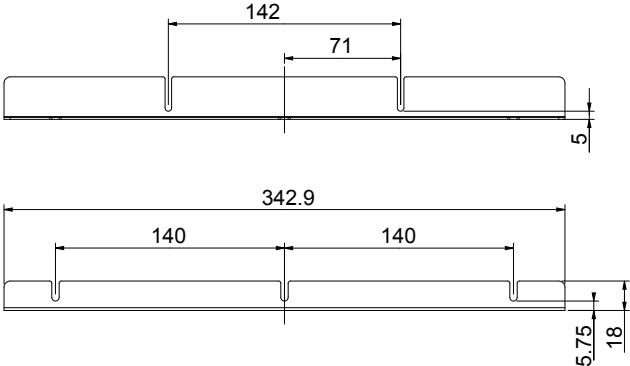
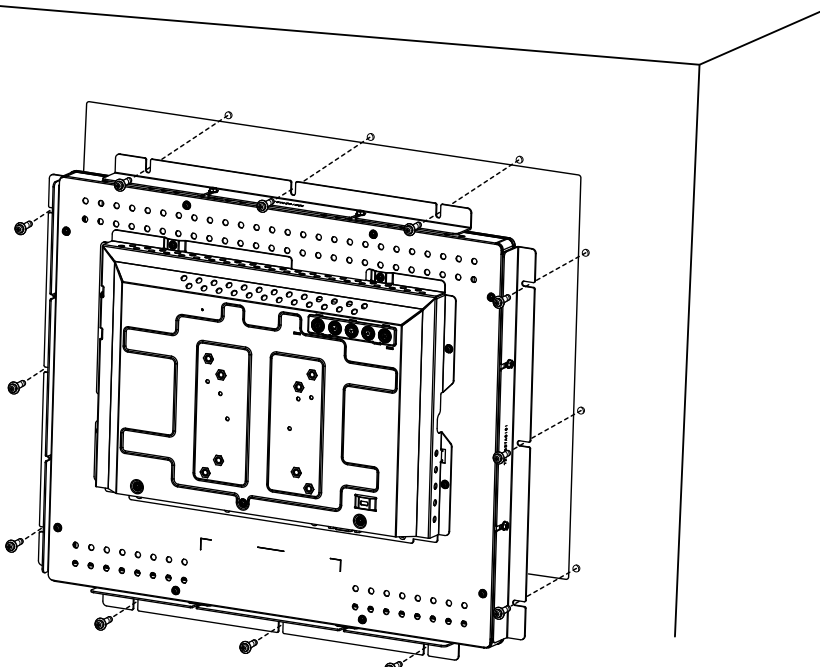

Customer panel material:

1. Wooden wall: $\text{Ø}4.5\text{mm}$ thru holes for M4 screws w/nuts, or no thru holes, screws for wood 4mm.
2. Sheet metal: concealed head threaded studs M4 w/nuts.

LA1950R/RTR/RTC/RTS

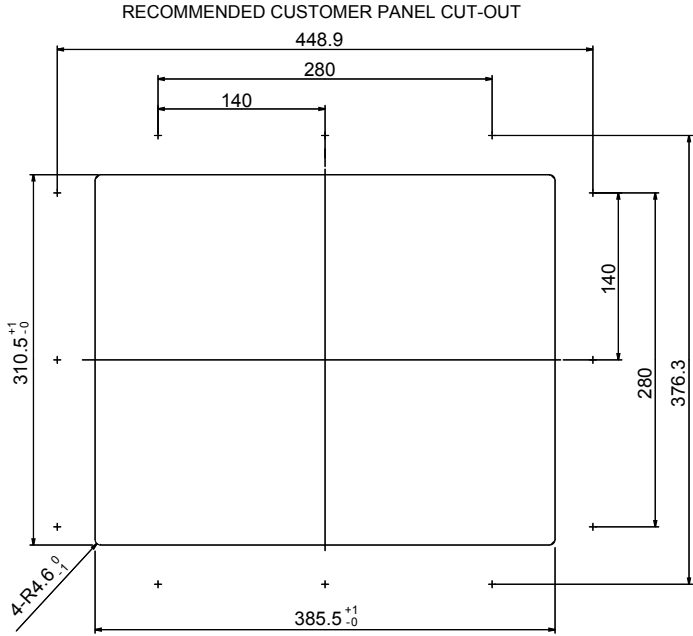

IMPORTANT!

The wall mounting instructions are for the qualified wall mounting person only!

Warning!

Please select the proper screws!

The distance between the back cover surface and the bottom of the screw hole is 8 mm. Please use four M4 screws diameter with proper length to mount your monitor.

Please note: the mounting stand must be able to support at least 13.2 lbs (6Kg).

Connecting the Display (Figure 10.1)

To setup this display, please refer to the following figure and procedures.

1. Be sure all equipment is turned off.
2. Connect the DC adapter to the power connector on the monitor and the other end into an electrical outlet (10.1).
3. Connect the D-SUB cable from the display's VGA input connector to the D-SUB connector of your host computer and tighten the screws (10.1).
4. Connect the RS-232 or USB cable from the RS-232 or USB port of your display to the RS-232 port (10.1) or USB port (10.1) of your computer.
5. Configure the touch screen. Refer to the "Touch Screen Driver Installation" section on page 18.
6. Once the touch screen is configured, the monitor is ready for use.
7. Connect the remote control cable to RJ11 port (10.1) (optional).

Notice!

To ensure the LCD display works well with your computer, please configure the display mode of your graphics card to make it less than or equal to 1280 x1024 resolution and make sure the timing of the display mode is compatible with the LCD display.

We have listed the compatible "Video Modes" of your LCD display in the appendix (on page 17) for your reference.

***Don't connect telephone or internet cable to RJ-11 port.
Adapter rating: 12Vdc 4A min., marked with LPS.***

(Figure 10.1)

LA1950RTR / LA1950RTC / LA1950RTS

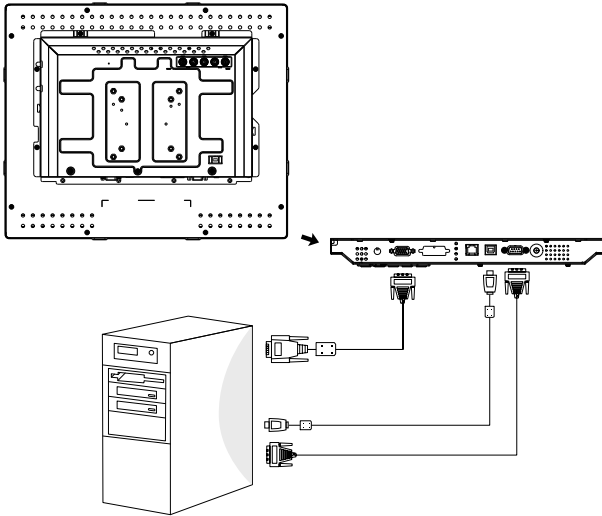

LA1950R

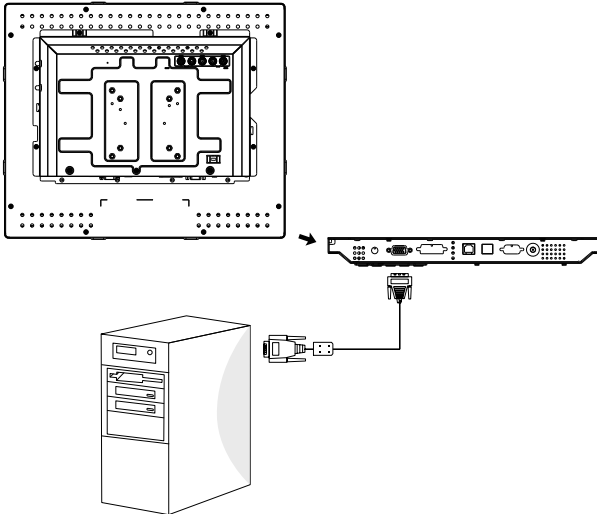



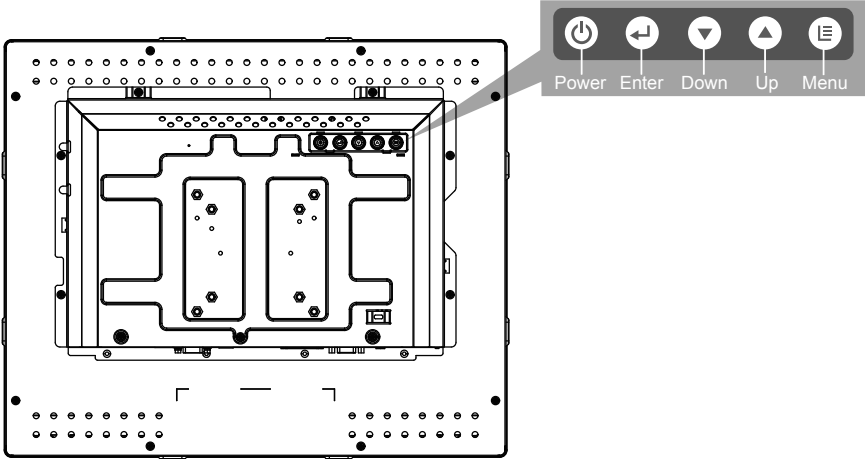

User Controls

Back Panel Controls



Key \ OSD	Menu off status	Menu on status
	☰	Menu appear
▲	Brightness	Main item select up/Adjust up
▼	Contrast	Main item select down/Adjust down
↵	Enter/Select sub-item function	
⏻	Power On/Off	

How to Use the OSD Menu

Icon	key Name
	Menu
	Up
	Down
	Enter
	Power

1. Press the “MENU” button to pop up the “on-screen menu” and press “Up” or “Down” button to select among the five functions in the main menus.
2. Choose the adjustment items by pressing the “Enter ” button.
3. Adjust the value of the adjustment items by pressing the “Up” or “Down” button.
4. With the OSD menu on screen, press “ Menu” button to return main menu or exit OSD.
5. The OSD menu will automatically close, if you have left it idle for a pre-set time.
6. To Lock the OSD / Power menu buttons, please follow the instructions below.
(Please note: the monitor has to be turned ON with a valid signal preset)
 - (a.) Press “Menu” key , the OSD menu will pops upon display.
 - (b.) Press and hold the “Menu” key again with the OSD menu on the screen, the OSD menu will disappear. Then press the “Power” key 1 time while the menu key is still being pressed. The “Lock/Unlock” menu will appear for 3 seconds.
 - (c.) Use the “Enter” key to select OSD or Power setting then set at “Lock” by pushing the “UP” or “Down” button.
 - (d.) When the “UP” or “Down” button is released, the previous setting will be saved and exit the “Lock/Unlock” menu automatically.
7. To Unlock the OSD / Power menu buttons, please follow the instructions below.
(Please note: the monitor has to be turned ON with a valid signal preset)
 - (a.) Press and hold the “Menu” key then press the “Power” key simultaneously, the “Lock/ Unlock” menu will appear for 3 seconds.
 - (b.) Use the “Enter” key to select OSD or Power setting then set at “Unlock” by pushing the “UP” or “Down” button.
 - (c.) When the “UP” or “Down” button is released, the previous setting will be saved and exit the “Lock/Unlock” menu automatically.

Please note:

- a. When the OSD Lock function is selected, this indicates that all the buttons except “power” button are now disabled.
- b. When the Power Lock function is selected, this indicates that the power key is disabled; user can not to turn off the monitor by “Power” key.

On-Screen Display Menus

Main OSD Menu:

ITEM	CONTENT
Contrast	The monitor luminance level control.
Brightness	The monitor backlight level control.
Auto Adjust	Fine-tune the image to full screen automatically.
Left/Right	Moving screen image horizontal position to left or right.
Up/Down	Moving screen image vertical position to up or down.
Horizontal size	The screen image horizontal dot clock adjustment.
Fine	The screen image pixel phase adjustment.
OSD Left/Right	Moving OSD menu horizontal position to left or right.
OSD Up/Down	Moving OSD menu vertical position to up or down.
OSD Time out	OSD auto-disappear time selection.
OSD Language	OSD menu language selection. (English, French, Japanese, Deutsch, Spanish, Italian, Traditional Chinese and Simplified Chinese)
Factory Reset	Factory default value restored.
RGB	Color temperature selection. (9300K, 6500K, 5500K, 7500K, User)

Appendix

Troubleshooting

If you are experiencing trouble with the LCD display, refer to the following. If the problem persists, please contact your local dealer or our service center.

Problem: No image appears on screen.

- ▶ Check that all the I/O and power connectors are correctly and well connected described in the "Installation" section.
- ▶ Make sure the pins of the connectors are not crooked or broken.

Problem: Partial Image or incorrectly displayed image.

- ▶ Check to see if the resolution of your computer is higher than that of the LCD display.
- ▶ Reconfigure the resolution of your computer to make it less than or equal to 1280 x 1024.

Problem: Image has vertical flickering line bars.

- ▶ Use "HORIZONTAL SIZE" to make an adjustment.
- ▶ Check and reconfigure the display mode of the vertical refresh rate of your graphic card to make it compatible with the LCD display.

Problem: Image is unstable and flickering

- ▶ Use "FINE" to make an adjustment.

Problem: Image is scrolling

- ▶ Check and make sure the VGA signal cable (or adapter) is securely connected.
- ▶ Check and reconfigure the display mode of the vertical refresh rate of your graphics card to make it compatible with the LCD display.

Problem: Vague image (characters and graphics)

- ▶ Use "HORIZONTAL SIZE" to make an adjustment. If this problem still exists, use "FINE" to make an adjustment.

Warning Signal

If you see warning messages on your LCD screen, this means that the LCD display cannot receive a clean signal from the computer graphics card.

There may be three sources for this problem. Please check the cable connections or contact your local dealer or our service center for more information.

No Signal

This message means that the LCD display has been powered on but it cannot receive any signal from the computer graphics card. Check all the power switches, power cables, and VGA signal cable.

Going to Sleep

The LCD display is under the power saving mode. In addition, the LCD display will enter power saving mode when experiencing a sudden signal disconnecting problem.

The monitor can be activated by pressing any keyboard, triggering the mouse or touching the screen.

Out of Range

This message means that the signal of the computer graphic card is not compatible with the LCD display. When the signal is not included in the "Video Modes" list we have listed in the Appendices of this manual, the LCD monitor will display this message.

Product Dimensions

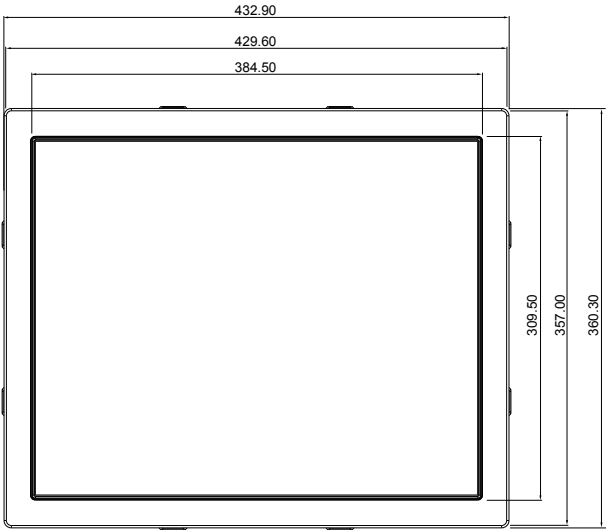

Front View

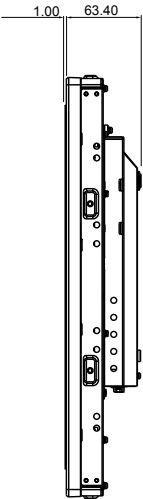

Side View

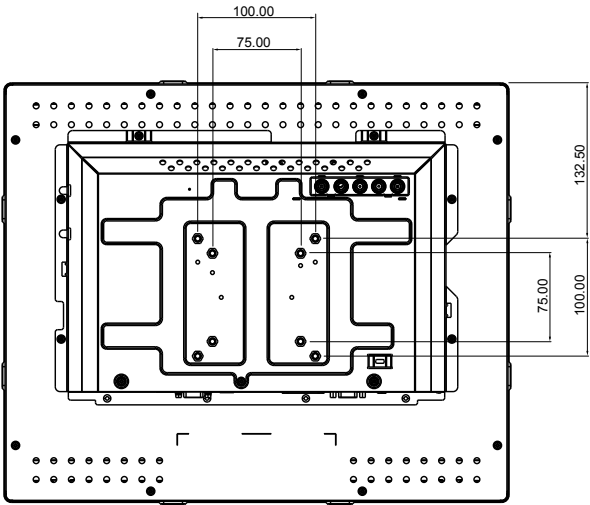

Back View

Compatibility Modes

Mode	Resolution	H-Frequency(khz)	V-Frequency(hz)
IBM VGA	720X400	31.47	70
IBM VGA	640X480	31.47	60
Apple MacII	640X480	35.00	66
VESA VGA	640X480	37.86	72
VESA VGA	640X480	37.50	75
VESA VGA	800X600	35.16	56
VESA VGA	800X600	37.88	60
VESA VGA	800X600	48.08	72
VESA VGA	800X600	46.88	75
Apple Mac	832X624	49.72	75
VESA XGA	1024X768	48.36	60
VESA XGA	1024X768	56.48	70
VESA XGA	1024X768	60.02	75
VESA SXGA	1280X1024	64.00	60
VESA SXGA	1280X1024	80.00	75
VESA SXGA	1152X864	67.50	75
VESA SXGA	1280X960	60.00	60

Touch Screen Driver Installation

The LA1950RTR / LA1950RTC / LA1950RTS is available with both RS232 and USB connections. The touch driver is available online for these operating systems: Windows® 7, VISTA 64/32 bits, XP, 2000, ME, 98, NT4.0, CE, XP Embedded, Linux, Apple® Mac OS.

Please Note: The LA1950RTR / LA1950RTC / LA1950RTS is Microsoft® Windows® HID (Human Interface Device) compatible if you use the USB touch screen interface. No additional software driver is required for general operation of the touch screen. A calibration tool can be installed for improved touch position accuracy. See “Optional Calibration Tool Install” section for more information.

LA1950RTR / LA1950RTC / LA1950RTS Optional Calibration Tool Install:

If you would like to use the Optional Calibration Tool, follow the instructions below. Please note: the calibration tool supports Windows® 7, VISTA, XP, XP Embedded, 2000, 98 and ME operating systems via USB only.

1. Download the calibration tool online.
2. Execute the calibration tool.
3. From here the user can choose to do the following:
 - a. 4 Points Calibration
 - b. 9 Points Linearization
 - c. 25 Points Linearization
 - d. Clear
 - e. Draw Test
 - f. Advanced. In the Advanced settings area the user may do the following:
 - i. Adjust the Double Click Area.
 - ii. Enable auto right click and adjust the auto right click time.
 - iii. Choose to be either in the HID Mouse Mode or HID Digitizer Mode (Windows® 7, Vista).
 - iv. Simply click the “Apply” button once the settings are finalized.

LA1950RTR / LA1950RTC / LA1950RTS Install Instructions:

If you are using a PC running Windows® 7, VISTA, XP, 2000, ME, 98, NT4.0, follow the instructions below:

1. Power on the PC.
2. Be sure the USB or the RS-232 Serial cable is connected from the PC to the LCD display.
3. Download the driver online and execute.
4. Follow the step-by-step instructions as shown on the pop-up windows.

If you are using a PC running Windows® XP Embedded, follow the instructions below:

Express:

1. Power on the computer.
2. Make sure that the RS232 or USB cable is connected to the computer.
3. Be sure that your EWF is disabled. If your EWF is enabled, please disable the EWF by using the EWF Manager command.
4. Once the EWF is disabled, download the driver online and execute.
5. Click on the XP driver and follow the step-by-step instructions as shown on the pop-up windows.

Custom:

1. Power on the computer.
2. Make sure that the RS232 or USB cable is connected to the computer.
3. Download the driver online and execute.
4. Follow the step-by-step instructions found in the folder file of the driver.

If you are using a PC running Windows® CE, follow the instructions below:

1. Power on the computer.
2. Make sure that the RS232 or USB cable is connected to the computer.
3. Using Platform Builder, build an image file by following the step-by-step instructions found in the folder file of the driver.

If you are using a PC running Linux or Apple® Mac OS, follow the instructions below:

1. Power on the computer.
2. Make sure that the RS232 or USB cable is connected to the computer.
3. Download the driver online and execute.
4. Follow the step-by-step instructions found in the folder file of the driver.

When changing the Touch Interface (RS-232 or USB), please follow instructions below.

1. Uninstall the touch driver.
2. Re-start the computer.
3. Remove the original Touch Interface (RS-232 or USB).
4. Connect the computer to the Touch Interface (RS-232 or USB) that you would like to use.
5. Download the Touch Driver online, then follow the step-by-step instructions as show on monitor.

PLEASE NOTE!

Don't plug in both the RS-232 and USB cables!

Doing so may cause a driver conflict, making your touch screen inoperable.

Product Registration and Technical Support

Register Your Planar Products Today

Thank you for choosing Planar. To assure you receive all the benefits of your Planar product and services, register your Planar product today. Visit our website to register your product at http://www.planar.com/support/product_registration.html.

Cables, Replacement Lamps, Accessories

To find cables, replacement lamps and accessories for your Planar projector, LCD monitor, touch screen or other Planar products visit our online store at www.PlanarOnline.com or find other stores who carry Planar products at <http://www.planar.com/howtobuy>.

Technical Support

Visit Planar at <http://www.planar.com/support> for product registration, operations manuals, touch screen drivers, warranty information and access to Planar's Technical Library for online troubleshooting.

To speak with Planar Customer Support please have your model and serial number available and dial:

Planar Support

Tel: 1-866-PLANAR1 (866-752-6271) or +1 503-748-5799 outside the US.

Hours: 24 hours a day, 7 days a week.

Toll or long distance charges may apply.

Planar Systems, Inc.

Customer Service

24x7 Online Technical Support: <http://www.planar.com/support>

1195 NW Compton Drive

Beaverton, OR 97006-1992

Tel: 1-866-PLANAR1 (866-752-6271) or +1 503-748-5799 outside the United States.

Hours: 24 hours a day, 7 days a week

© 2010 **Planar Systems, Inc. 12/10** Planar is a registered trademark of Planar Systems, Inc.

Other brands and names are the property of their respective owners.

Technical information in this document is subject to change without notice.

020-1061-00 Rev A